

UHF RFID System V780-series Reader/Writer

User's Manual (EtherNet/IP™)

Standard Reader/Writer

V780-HMD68-EIP-JP
V780-HMD68-EIP-KR
V780-HMD68-EIP-CN
V780-HMD68-EIP-TW
V780-HMD68-EIP-IN
V780-HMD68-EIP-ID
V780-HMD68-EIP-MY
V780-HMD68-EIP-SG
V780-HMD68-EIP-EU
V780-HMD68-EIP-RU
V780-HMD68-EIP-US
V780-HMD68-EIP-MX

Slave Reader/Writer

V780-HMD68-ETN-JP-S
V780-HMD68-ETN-KR-S
V780-HMD68-ETN-CN-S
V780-HMD68-ETN-TW-S
V780-HMD68-ETN-IN-S
V780-HMD68-ETN-ID-S
V780-HMD68-ETN-MY-S
V780-HMD68-ETN-SG-S
V780-HMD68-ETN-EU-S
V780-HMD68-ETN-RU-S
V780-HMD68-ETN-US-S
V780-HMD68-ETN-MX-S



NOTE

All rights reserved. No part of this publication may be reproduced, stored in a retrieval system, or transmitted, in any form, or by any means, mechanical, electronic, photocopying, recording, or otherwise, without the prior written permission of OMRON.

No patent liability is assumed with respect to the use of the information contained herein. Moreover, because OMRON is constantly striving to improve its high-quality products, the information contained in this manual is subject to change without notice. Every precaution has been taken in the preparation of this manual. Nevertheless, OMRON assumes no responsibility for errors or omissions. Neither is any liability assumed for damages resulting from the use of the information contained in this publication.

Trademarks

- Microsoft, Windows, Windows Vista, Excel, Internet Explorer, and Visual Basic are either registered trademarks or trademarks of Microsoft Corporation in the United States and other countries.
- EtherNet/IP is a registered trademark of ODVA, Inc..
- Java and other trademarks that contain "Java" are the registered trademarks of Oracle Corporation or its related companies.

Other company names and product names in this document are the trademarks or registered trademarks of their respective companies.

Copyrights

Microsoft product screen shots reprinted with permission from Microsoft Corporation.

Introduction

Thank you for purchasing a V780-HMD68-EIP-□□/V780-HMD68-ETN-□□-S RFID System. This manual contains information that is necessary to use the V780-HMD68-EIP-□□/V780-HMD68-ETN-□□-S. Please read this manual and make sure you understand the functionality and performance of the Reader/Writer before you attempt to use it in an RFID system.

Keep this manual in a safe place where it will be available for reference during operation.

Intended Audience

This manual is intended for the following personnel, who must also have knowledge of electrical systems (an electrical engineer or the equivalent).

- Personnel in charge of introducing FA systems
- Personnel in charge of designing FA systems
- Personnel in charge of installing and connecting FA systems
- Personnel in charge of managing FA systems and facilities

Applicable Products

This manual covers the following products.

- V780-series Reader/Writers for UHF RFID Systems for 920-MHz-band Moving Object Differentiation Wireless Facilities
 - V780-HMD68-EIP-JP/V780-HMD68-ETN-JP-S
 - V780-HMD68-EIP-KR/V780-HMD68-ETN-KR-S
 - V780-HMD68-EIP-CN/V780-HMD68-ETN-CN-S
 - V780-HMD68-EIP-TW/V780-HMD68-ETN-TW-S
 - V780-HMD68-EIP-IN/V780-HMD68-ETN-IN-S
 - V780-HMD68-EIP-ID/V780-HMD68-ETN-ID-S
 - V780-HMD68-EIP-MY/V780-HMD68-ETN-MY-S
 - V780-HMD68-EIP-SG/V780-HMD68-ETN-SG-S
 - V780-HMD68-EIP-EU/V780-HMD68-ETN-EU-S
 - V780-HMD68-EIP-RU/V780-HMD68-ETN-RU-S
 - V780-HMD68-EIP-US/V780-HMD68-ETN-US-S
 - V780-HMD68-EIP-MX/V780-HMD68-ETN-MX-S

Terms and Conditions Agreement

Warranty, Limitations of Liability

Warranties

● Exclusive Warranty

Omron's exclusive warranty is that the Products will be free from defects in materials and workmanship for a period of twelve months from the date of sale by Omron (or such other period expressed in writing by Omron). Omron disclaims all other warranties, express or implied.

● Limitations

OMRON MAKES NO WARRANTY OR REPRESENTATION, EXPRESS OR IMPLIED, ABOUT NON-INFRINGEMENT, MERCHANTABILITY OR FITNESS FOR A PARTICULAR PURPOSE OF THE PRODUCTS. BUYER ACKNOWLEDGES THAT IT ALONE HAS DETERMINED THAT THE PRODUCTS WILL SUITABLY MEET THE REQUIREMENTS OF THEIR INTENDED USE.

Omron further disclaims all warranties and responsibility of any type for claims or expenses based on infringement by the Products or otherwise of any intellectual property right.

● Buyer Remedy

Omron's sole obligation hereunder shall be, at Omron's election, to (i) replace (in the form originally shipped with Buyer responsible for labor charges for removal or replacement thereof) the non-complying Product, (ii) repair the non-complying Product, or (iii) repay or credit Buyer an amount equal to the purchase price of the non-complying Product; provided that in no event shall Omron be responsible for warranty, repair, indemnity or any other claims or expenses regarding the Products unless Omron's analysis confirms that the Products were properly handled, stored, installed and maintained and not subject to contamination, abuse, misuse or inappropriate modification. Return of any Products by Buyer must be approved in writing by Omron before shipment. Omron Companies shall not be liable for the suitability or unsuitability or the results from the use of Products in combination with any electrical or electronic components, circuits, system assemblies or any other materials or substances or environments. Any advice, recommendations or information given orally or in writing, are not to be construed as an amendment or addition to the above warranty.

See <http://www.omron.com/global/> or contact your Omron representative for published information.

Limitation on Liability; Etc

OMRON COMPANIES SHALL NOT BE LIABLE FOR SPECIAL, INDIRECT, INCIDENTAL, OR CONSEQUENTIAL DAMAGES, LOSS OF PROFITS OR PRODUCTION OR COMMERCIAL LOSS IN ANY WAY CONNECTED WITH THE PRODUCTS, WHETHER SUCH CLAIM IS BASED IN CONTRACT, WARRANTY, NEGLIGENCE OR STRICT LIABILITY.

Further, in no event shall liability of Omron Companies exceed the individual price of the Product on which liability is asserted.

Application Considerations

Suitability of Use

Omron Companies shall not be responsible for conformity with any standards, codes or regulations which apply to the combination of the Product in the Buyer's application or use of the Product. At Buyer's request, Omron will provide applicable third party certification documents identifying ratings and limitations of use which apply to the Product. This information by itself is not sufficient for a complete determination of the suitability of the Product in combination with the end product, machine, system, or other application or use. Buyer shall be solely responsible for determining appropriateness of the particular Product with respect to Buyer's application, product or system. Buyer shall take application responsibility in all cases.

NEVER USE THE PRODUCT FOR AN APPLICATION INVOLVING SERIOUS RISK TO LIFE OR PROPERTY OR IN LARGE QUANTITIES WITHOUT ENSURING THAT THE SYSTEM AS A WHOLE HAS BEEN DESIGNED TO ADDRESS THE RISKS, AND THAT THE OMRON PRODUCT(S) IS PROPERLY RATED AND INSTALLED FOR THE INTENDED USE WITHIN THE OVERALL EQUIPMENT OR SYSTEM.

Programmable Products

Omron Companies shall not be responsible for the user's programming of a programmable Product, or any consequence thereof.

Disclaimers

Performance Data

Data presented in Omron Company websites, catalogs and other materials is provided as a guide for the user in determining suitability and does not constitute a warranty. It may represent the result of Omron's test conditions, and the user must correlate it to actual application requirements. Actual performance is subject to the Omron's Warranty and Limitations of Liability.

Change in Specifications

Product specifications and accessories may be changed at any time based on improvements and other reasons. It is our practice to change part numbers when published ratings or features are changed, or when significant construction changes are made. However, some specifications of the Product may be changed without any notice. When in doubt, special part numbers may be assigned to fix or establish key specifications for your application. Please consult with your Omron's representative at any time to confirm actual specifications of purchased Product.

Errors and Omissions

Information presented by Omron Companies has been checked and is believed to be accurate; however, no responsibility is assumed for clerical, typographical or proofreading errors or omissions.

Safety Precautions

Definition of Precautionary Information



The following notation and alert symbols are used in this User's Manual to provide precautions required to ensure safe usage of the V780-HMD68-EIP-□□/ V780-HMD68-ETN-□□-S Reader/Writer.

The safety precautions that are provided are extremely important to safety. Always read and heed the information provided in all safety precautions.







The following notation is used.









 WARNING	Indicates a potentially hazardous situation which, if not avoided, will result in minor or moderate injury, or may result in serious injury or death. Additionally there may be significant property damage.
--	--

Alert Symbols

-
- | | |
|--|---|
|  | The triangle symbol indicates precautions (including warnings).
The specific operation is shown in the triangle and explained in text.
This example on the left indicates a general precaution. |
|--|---|
-
- | | |
|---|--|
|  | The filled circle symbol indicates operations that you must do.
The specific operation is shown in the circle and explained in text.
This example on the left shows a general precaution for something that you must do. |
|---|--|
-

Warnings

 WARNING	
The V780-HMD68-EIP-JP/V780-HMD68-ETN-JP-S can be used only in Japan.	
The V780-HMD68-EIP-KR/V780-HMD68-ETN-KR-S can be used only in Korea.	
The V780-HMD68-EIP-CN/V780-HMD68-ETN-CN-S can be used only in China.	
The V780-HMD68-EIP-TW/V780-HMD68-ETN-TW-S can be used only in Taiwan.	
The V780-HMD68-EIP-IN/V780-HMD68-ETN-IN-S can be used only in India.	

<p>The V780-HMD68-EIP-ID/V780-HMD68-ETN-ID-S can be used only in Indonesia.</p>	
<p>The V780-HMD68-EIP-MY/V780-HMD68-ETN-MY-S can be used only in Malaysia.</p>	
<p>The V780-HMD68-EIP-SG/V780-HMD68-ETN-SG-S can be used only in Singapore and Thailand.</p>	
<p>The V780-HMD68-EIP-EU/V780-HMD68-ETN-EU-S can be used only in the European countries under the RE Directive (2014/53/EU).</p>	
<p>The V780-HMD68-EIP-RU/V780-HMD68-ETN-RU-S can be used only in Russia.</p>	
<p>The V780-HMD68-EIP-US/V780-HMD68-ETN-US-S can be used only in the United States and Canada.</p>	
<p>The V780-HMD68-EIP-MX/V780-HMD68-ETN-MX-S can be used only in Mexico.</p>	
<p>Falling when working in high locations may result in injury. Do not work anywhere that the footing is not stable.</p>	
<p>Injury may occur if the Reader/Writer falls and strikes a person. Observe the following precautions when installing the Reader/Writer.</p> <ul style="list-style-type: none"> • Do not work when there are persons below you. • Observe all torque specifications for bolts. 	

Precautions for Safe Use

Observe the following precautions to ensure safety.

Transportation

- The Reader/Writer may be damaged if it falls from a high location. When you transport Reader/Writers, do not stack them too high.
- Injury may occur if the Reader/Writer falls. Do not let the Reader/Writer fall when you carry it.

Installation and Removal

- The Reader/Writer weighs approx. 3 kg. It may be damaged if it falls. Use slip-resistant gloves when you install the Reader/Writer and hold the Reader/Writer securely at the depressions with both hands.

Wiring

- The Reader/Writer may be damaged. Wire it correctly.
- The cables may break. Confirm cable specifications and do not bend cables past their normal bending radius.
- The Reader/Writer may be damaged. Never use an AC power supply.
- Connect the Ethernet cable to a host device (e.g., Switching Hub or PLC) that supports STP and ground the host device to a ground resistance of 100 Ω or less.

Usage

- The communications range depends on the operating and installation environment. Use the Reader/Writer only after sufficiently testing operation onsite.
- If multiple Reader/Writers are installed near each other, communications distances may decrease due to mutual interference. Refer to *A-5 Mutual Interference of Reader/Writers (Reference Only)* on page A-25 and check to make sure there is no mutual interference between Reader/Writers.

Errors and Failures

- If an error is detected in the Reader/Writer, immediately stop operation and turn OFF the power supply. Consult with an OMRON representative.

Maintenance

- Using thinner, benzene, acetone, or kerosene may adversely affect the plastic parts and case coating. Refer to *A-6 Chemical Resistance of the Reader/Writers* on page A-29 and do not use any chemicals that would have a negative effect.

Disposal

- Dispose of the Reader/Writer as industrial waste.

Precautions for Correct Use

Always observe the following precautions to prevent operation failures, malfunctions, and adverse effects on performance and equipment.

Transportation

- Always use the packing box that comes with the Reader/Writer when you transport it, and do not subject it to excessive vibration or shock.

Installation

- After you tighten the bolts, make sure that the Reader/Writer is securely attached.
- In V780-HMD68-EIP-IN/-EU/-RU, and V780-HMD68-ETN-IN-S/-EU-S/-RU-S attach the supplied ferrite core to the power cable and Ethernet cable before use.

Installation and Storage Environment

Do not use or store the Reader/Writer in the following locations.

- Locations subject to combustible gases, explosive gases, corrosive gases, dust, dirt, metal powder, or salt
- Locations where the specified ambient temperature or ambient humidity range is exceeded
- Locations subject to extreme temperature changes that may result in condensation
- Locations where the Reader/Writer would be directly subjected to vibration or shock exceeding specifications
- Locations subject to water exposure that exceeds the specifications

Storage Methods

- Injury or damage may occur if the Reader/Writer falls. Implement safety measures so that the Reader/Writer will not fall.

Wiring

- To use the Reader/Writer in Run Mode, connect the control signal to +24 VDC of the power supply. If you connect the control signal to the 0-V side of the power supply, the Reader/Writer will start in Safe Mode.
- The Reader/Writer may be destroyed. Do not exceed the rated voltage range.

Usage

- The Reader/Writer may fail if it is used with a damaged cable. Do not subject the cable to strong forces or place heavy objects on the cable.
- Observe the tightening torque specifications for the power supply and communications connectors.
- The Reader/Writer may fail or become unreliable if heat cannot be dissipated sufficiently. Ensure that heat can be dissipated around the Reader/Writer.
- Do not use the Reader/Writer outdoors.
- Do not attempt to disassemble, repair, or modify the Reader/Writer.

Maintenance

- Perform inspections both daily and periodically.
- The Reader/Writer may fail if it or its wiring is replaced while the power supply is ON. Always turn OFF the power supply before you replace the Reader/Writer or its wiring.

Compliance with Laws and Regulations

- V780-HMD68-EIP-JP/V780-HMD68-ETN-JP-S is a wireless facility conforming to the construction type certification of premises radio station based on the Japanese Radio Act. It cannot be used outside of Japan. Perform the licensing procedures of the premises radio station in order to use the Reader/Writer.

Standards and Regulations

V780-HMD68-EIP-JP/V780-HMD68-ETN-JP-S is a wireless facility conforming to the construction type certification of premises radio station (920-MHz-band Moving Object Differentiation Wireless Facilities) based on the Japanese Radio Act. It cannot be used outside of Japan.

Standards in Japan

Premises Radio Station (920-MHz-band Moving Object Differentiation Wireless Facilities) (ARIB STD-T106 Standard)

Authentication No.: 001-P00881

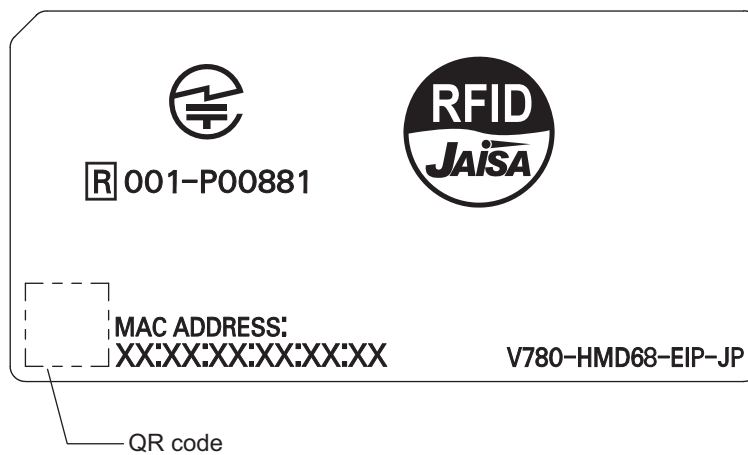

● About Human Exposure

In accordance with Article 21-3 of the Japan Radio Law Enforcement Regulations, this product shall be installed so that no one is allowed to stay at a location within 72cm from the antenna.

* Within 72cm is when the output setting of this product is 27dBm. When the output setting is 21dBm, it is within 36cm, and when it is 15dBm, it is within 18cm.

Licensing Procedures of Premises Radio Station

V780-HMD68-EIP-JP/V780-HMD68-ETN-JP-S is a wireless facility to differentiate moving object using the 920-MHz band. The licensing procedures of the premises radio station must be performed before use. Be sure to perform the licensing procedures before use. The licensing procedures are described in the Appendix.

Refer to *Licensing Procedures of Premises Radio Station* on page A-2.

Manual Structure

Page Structure

The following page structure is used in this manual.

Level 2 heading

Level 3 heading

A step in a procedure
Indicates a procedure.

Special information
Icons indicate precautions, additional information, or reference information.

Manual name

4 Installation and Connections

4-2 Connections and Wiring

4-2-1 Connecting and Removing the Reader/Writer Power Cable and Ethernet Cable

Power Supply

Connect a power supply that meets the following conditions to the Reader/Writer.

Item	Condition
Supply voltage	24 VDC -15% to +10%
Output current	500 mA min.
Safety standard	SELV (Safety Extra Low Voltage)

Connecting Method

1 Hold onto the connector on the Power Cable and insert it into the power connector on the Reader/Writer.

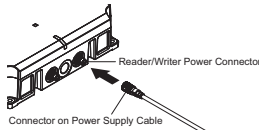

Precautions for Correct Use

Do not apply more than 30 N of force to the connector on the Reader/Writer.

2 Turn the connector on the Power Cable clockwise to lock it in place.

- For the Recommended Cable
Turn the cable connector clockwise until you hear it securely lock in place.
- For Other Cables
Observe the tightening torque specifications for the cable connectors.

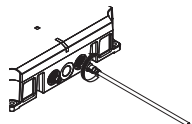

Pin No.	Name	Description	I/O
1	24P	+24 V	---
2	CONT	Control signal (operating mode signal) *1. Run Mode: Connect to +24 V and then start the Reader/Writer. Safe Mode: Connect to 0 V and then start the Reader/Writer.	IN
3	24N	0 V	---
4	---	---	---

Precautions for Correct Use

Pin 4 on the power supply connector is not used. Do not connect it to any terminal.

Level 1 heading

Level 2 heading

Level 3 heading
Give the current headings.

Page tab
Gives the number of the main section.

Note This illustration is provided only as a sample. It may not literally appear in this manual.

Special Information

Special information in this manual is classified as follows:



Precautions for Safe Use

Precautions on what to do and what not to do to ensure safe usage of the product.



Precautions for Correct Use

Precautions on what to do and what not to do to prevent malfunction of the product or adverse affects on performances and functions.



Additional Information

Additional information to read as required.

This information is provided to increase understanding or make operation easier.



Version Information

Information about the differences in specifications and functions based on the version of Reader/Writer.

Note References to detailed information or related information.

About the Device Display

Items common to models V780-HMD68-EIP-JP/-KR/-CN/-TW/-IN/-ID/-MY/-SG/-EU/-RU/-US/-MX are written as “V780-HMD68-EIP-□□.”

Items common to models V780-HMD68-ETN-JP-S/-KR-S/-CN-S/-TW-S/-IN-S/-ID-S/-MY-S/-SG-S/-EU-S/-RU-S/-US-S/-MX-S are written as “V780-HMD68-EIP-□□.”

Sections in this Manual

1	Product Overview	10	Maintenance and Inspection	1	10
2	System Configuration	A	Appendix	2	A
3	Part Names and Functions	I	Index	3	I
4	Installation and Connections			4	
5	Preparations for Communications			5	
6	Functions			6	
7	EtherNet/IP Communications			7	
8	Browser Interface			8	
9	Troubleshooting			9	

CONTENTS

Introduction	1
Terms and Conditions Agreement	2
Safety Precautions	4
Precautions for Safe Use	6
Precautions for Correct Use	7
Standards and Regulations	9
Licensing Procedures of Premises Radio Station	10
Manual Structure	11
Sections in this Manual	13
Revision History	18
Version Upgrade Information	19

Section 1 Product Overview

1-1 Features	1-2
1-2 Application Flowchart	1-5
1-3 Reader/Writer Specifications	1-6
1-3-1 Appearance	1-6
1-3-2 General Specifications	1-6
1-3-3 Tag Communications Specifications	1-8
1-3-4 Recommended Power Supply (24 VDC)	1-14
1-3-5 Dimensions	1-14
1-4 RF Tag Specifications	1-15

Section 2 System Configuration

2-1 RFID System Configuration	2-2
-------------------------------------	-----

Section 3 Part Names and Functions

3-1 Operation Indicators	3-2
3-1-1 Names and Descriptions of Operation Indicators	3-2
3-1-2 Operation Indicators at Startup	3-4
3-1-3 Operation Indicators for WDT Errors	3-5
3-1-4 Operation Indicators for IP Address Conflict	3-5
3-1-5 Operation Indicators When BOOTP Server Connection Fails	3-6
3-1-6 Operation Indicators during Command Execution	3-6
3-1-7 Operation Indicators during Test Execution	3-9
3-1-8 Operation Indicators for System Errors	3-10
3-1-9 Operation Indicators when a Timeout is Detected in a Tag Data Link	3-12
3-1-10 During Multi-Reader/Writer function use	3-13
3-2 Connectors	3-15

Section 4 Installation and Connections

4-1	Installation.....	4-2
4-1-1	Reader/Writer	4-2
4-1-2	RF Tags	4-4
4-2	Connections and Wiring	4-6
4-2-1	Connecting and Removing the Reader/Writer Power Cable and Ethernet Cable	4-6

Section 5 Preparations for Communications

5-1	Starting the Reader/Writer	5-2
5-1-1	Procedure to Start the Reader/Writer	5-2
5-2	Setting IP Addresses	5-3
5-2-1	Preparations for Work	5-3
5-2-2	Setting the IP Address of the Reader/Writer from a Web Browser	5-5
5-2-3	Setting the IP Address of the Reader/Writer on the Network Configurator	5-7
5-3	Setting Tag Data Links	5-10

Section 6 Functions

6-1	Operation Modes	6-3
6-1-1	Run Mode	6-3
6-1-2	Safe Mode	6-3
6-2	RF Tag Communications	6-4
6-2-1	Single-access Communications	6-4
6-2-2	Multiaccess Communications	6-5
6-2-3	RF Communications Modes	6-6
6-2-4	Communications Commands	6-15
6-3	Reader/Writer Controls	6-20
6-3-1	Initialization	6-20
6-3-2	Resetting	6-20
6-3-3	RESET FOCUS	6-21
6-3-4	Installation Location Notification	6-22
6-4	Reader/Writer Settings	6-23
6-4-1	Network Settings	6-23
6-4-2	RF Communications Conditions: Basic Settings	6-24
6-4-3	RF Communications Conditions: Advanced Settings	6-26
6-4-4	Device Settings	6-33
6-4-5	Exporting/Important Configuration Files	6-35
6-5	Maintenance: Device Information	6-36
6-5-1	Reading Device Information	6-36
6-5-2	Getting the Operating Status	6-36
6-5-3	Getting and Setting Time Information	6-36
6-6	Maintenance: Log Information	6-37
6-6-1	Getting and Clearing the System Error Log	6-37
6-6-2	Getting the Command Error Log	6-38
6-6-3	Getting the Most Recent Command Error Information	6-38
6-7	Maintenance: Communications Information	6-39
6-7-1	Getting the Reception Level	6-39
6-7-2	Getting the Noise Level	6-39
6-7-3	Communications Diagnostics	6-40
6-8	Tuning	6-45
6-8-1	Transmission Power Tuning	6-45

6-9 Utilities	6-48
6-9-1 RF Tag Access	6-48
6-9-2 RF Tag Scanning.....	6-49
6-9-3 Reception Level Monitor	6-50
6-9-4 Channel Monitor.....	6-56
6-9-5 Focus Monitor	6-57
6-10 Multi-Reader/Writer Function	6-60
6-10-1 Outline.....	6-60
6-10-2 Multi-Reader/Writer Modes	6-61
6-10-3 Application.....	6-68
6-10-4 Communications conditions during Multi-Reader/Writer use	6-77
6-10-5 Maintenance functions during Multi-Reader/Writer use	6-78

Section 7 Ethernet/IP Communications

7-1 Outline	7-2
7-1-1 EtherNet/IP Communications Protocol.....	7-2
7-1-2 EtherNet/IP Communications with the Reader/Writer	7-3
7-1-3 Tag Data Link Setting Methods	7-4
7-1-4 Memory Assignments.....	7-7
7-1-5 Update Counter/Update Counter Response	7-10
7-1-6 V780 Commands	7-11
7-2 V780 Command Details	7-13
7-2-1 Single-access Communications Commands.....	7-13
7-2-2 Multiaccess Communications Commands	7-23
7-2-3 Reader/Writer Control Commands.....	7-27
7-2-4 Setting and Getting Reader/Writer Information Settings	7-30
7-2-5 Reader/Writer Setting Commands: Device Settings	7-33
7-2-6 Reader/Writer Setting Commands: Communications Settings	7-37
7-2-7 Maintenance Commands: Device Information	7-62
7-2-8 Maintenance Commands: Log Information	7-66
7-2-9 Maintenance Commands: RF Communications Information.....	7-71
7-2-10 Time Charts.....	7-77

Section 8 Browser Interface

8-1 Browser Operation Interface	8-2
8-2 Operation Interface	8-4
8-2-1 Password Entry View	8-4
8-2-2 Status.....	8-5
8-2-3 Network Settings	8-6
8-2-4 RF Communications Settings.....	8-9
8-2-5 Device Settings	8-13
8-2-6 Tuning	8-15
8-2-7 Utilities.....	8-17
8-2-8 Logs	8-26
8-2-9 Rebooting.....	8-32
8-2-10 Configuration.....	8-33
8-2-11 Configuration File	8-41

Section 9 Troubleshooting

9-1 Types of Errors	9-2
9-1-1 Errors Indicated on Operation Indicators	9-2
9-1-2 Errors Indicated with Error Codes.....	9-3

9-2	Error Tables	9-4
9-2-1	Command Errors	9-4
9-2-2	System Errors	9-6
9-2-3	WDT Errors	9-7
9-3	Errors and Countermeasures	9-8
9-3-1	Command Errors	9-8
9-3-2	RF Tag Communications Error	9-10
9-3-3	Minor Fault.....	9-14
9-3-4	Major Fault.....	9-17
9-3-5	WDT Error.....	9-17
9-4	Cannot Display the Web Browser Operation Window	9-18
9-4-1	Problem	9-18
9-4-2	Solution.....	9-19
9-4-3	Java installation	9-20
9-4-4	Java Security Settings	9-21
9-4-5	Java Security Settings Are Not Displayed	9-22
9-4-6	Register Trusted Site	9-23
9-4-7	Countermeasures for Other Problems	9-24

Section 10 Maintenance and Inspection

10-1	Maintenance and Inspection	10-2
------	----------------------------------	------

Section A Appendices

A-1	Licensing Procedures of Premises Radio Station	A-2
A-2	RF Tag Communications Times (for Reference Only).....	A-4
A-3	RF Tag Memory Map.....	A-17
A-4	Communications Range Diagram, Reception Level Diagram (Reference Only)	A-18
A-5	Mutual Interference of Reader/Writers (Reference Only).....	A-25
A-6	Chemical Resistance of the Reader/Writers	A-29

Index

Revision History

A manual revision code appears as a suffix to the catalog number on the front and back covers of the manual.

Cat. No.	Z402-E1-07
-----------------	-------------------

↑
Revision code

Revision code	Date	Revised contents
01	July 2018	Original production
02	November 2018	Content regarding models for various countries added (V780-HMD68-EIP-KR/-CN/-IN/-MY/-EU/-MX)
03	January 2019	Content regarding models for various countries added (V780-HMD68-EIP-TW/-RU)
04	July 2019	Changed the description of Java version.
05	September 2019	Content regarding models for various countries added (V780-HMD68-EIP-ID) Added the description of V780-HMD68-ETN-□□-S Change communications time at multi access Added description about transmission power tuning to "9-3-2 RF Tag Communications Error"
06	October 2019	Content regarding models for various countries added (V780-HMD68-EIP-SG) Added a workaround to "9-4 Cannot Display the Web Browser Operation Window on page 9-18"
07	December 2019	Made minor corrections

Version Upgrade Information

This section describes the version upgrade details of firmware.

Ver 3.00 → Ver 3.01

Change content	Page
The communications time at multi access of "A-2 RF Tag Communications Times (For reference only)"	P. A-4



1

Product Overview

This section describes the features, overall operation flow, and product specifications of the V780 Reader/Writer.

1-1	Features	1-2
1-2	Application Flowchart	1-5
1-3	Reader/Writer Specifications	1-6
1-3-1	Appearance	1-6
1-3-2	General Specifications	1-6
1-3-3	Tag Communications Specifications	1-8
1-3-4	Recommended Power Supply (24 VDC)	1-14
1-3-5	Dimensions	1-14
1-4	RF Tag Specifications	1-15

1-1 Features

The integrated V780-series Reader/Writer (V780-HMD68-EIP-□□) performs communications with RF Tags according to commands from a host device. It communicates with the host device via EtherNet/IP.

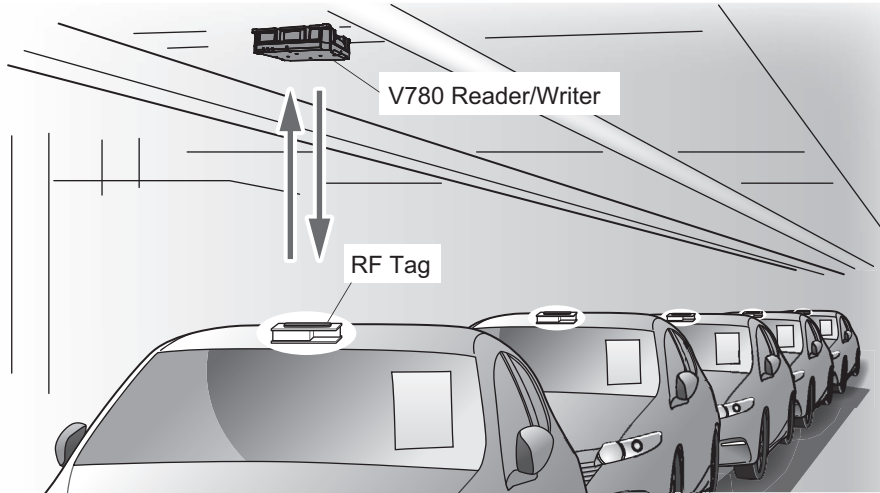

Integrated Structure

The controller, amplifier, and antenna are integrated into the Reader/Writer for a simple structure.

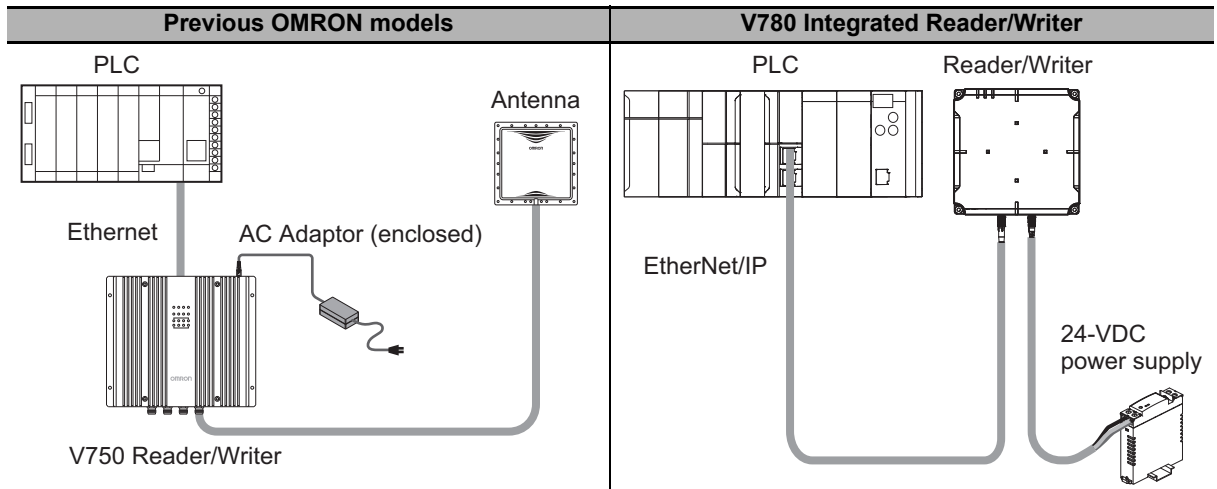

Simple Connection with EtherNet/IP

The Reader/Writer communicates with the host device through EtherNet/IP. EtherNet/IP is an industrial multi-vendor network that uses Ethernet. The EtherNet/IP specifications are open standards managed by the ODVA (Open DeviceNet Vendor Association). EtherNet/IP is used by a wide range of industrial devices.

Because EtherNet/IP uses standard Ethernet technology, various general-purpose Ethernet devices can be used in the network. You can easily increase the number of Reader/Writers by using a Switching Hub.

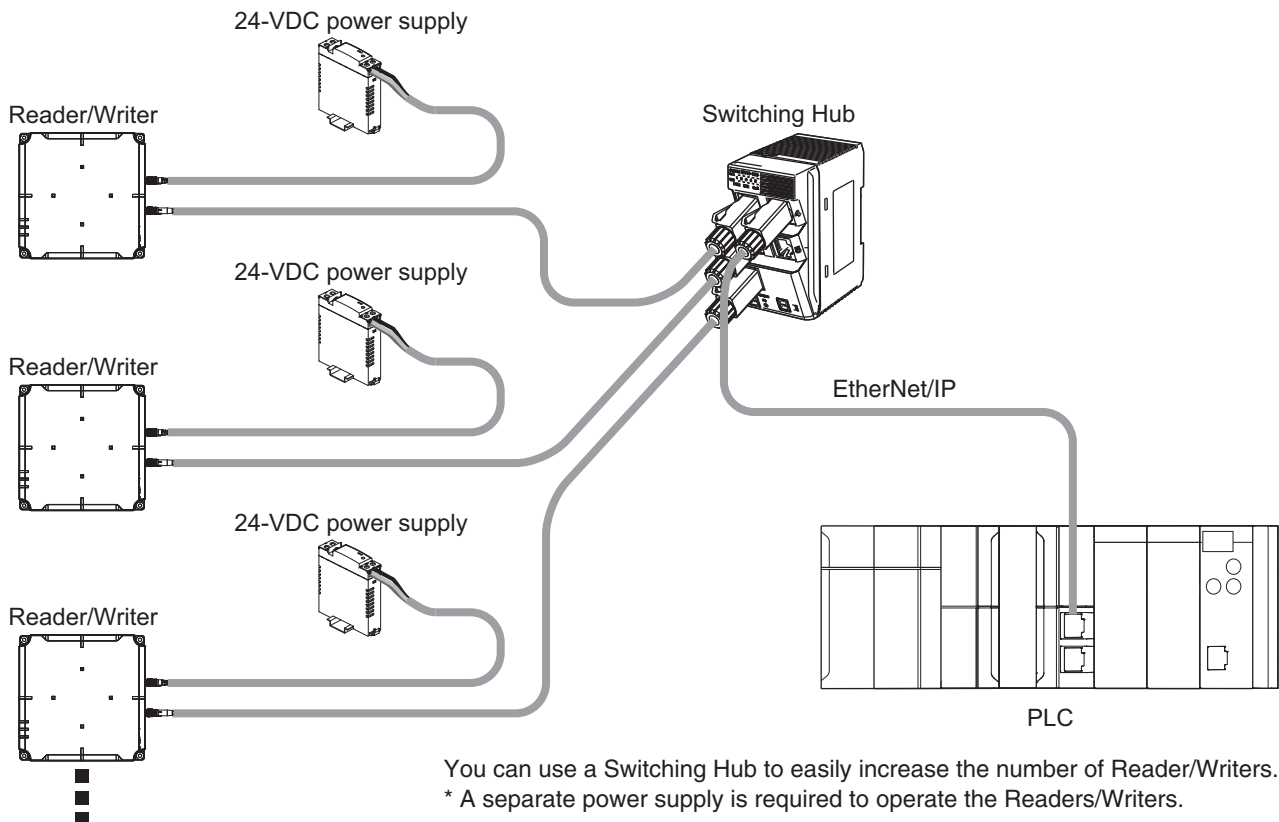

Precautions for Correct Use

To connect more than one Reader/Writer, all devices must be set to a unique IP address.

EtherNet/IP has mainly the following features.

High-speed, High-capacity Data Exchange through Tag Data Links (Cyclic Communications)

The EtherNet/IP protocol supports EtherNet/IP-standard implicit communications, which allows cyclic communications (called tag data links) with EtherNet/IP devices.

Tag Data Links (Cyclic Communications) at a Specified Communications Cycle for Each Application Regardless of the Number of Nodes

Tag data links (cyclic communications) operate at the cyclic period that is specified for each application, regardless of the number of nodes. Data is exchanged over the network at the refresh cycle that is set for each connection. The communications refresh cycle will not increase even if the number of nodes is increased, i.e., the concurrency of the connection's data is maintained.

Because the refresh cycle can be set for each connection, each application can communicate at its ideal refresh cycle. For example, interprocess interlocks can be transferred at high speed, while the production commands and the status information are transferred at low speed.

Easy Operation with a Browser Interface

A Web browser interface is built in, so you do not need special software.

Just connect the computer to the Reader/Writer from your browser to easily communicate with RF Tags, make Reader/Writer settings, and monitor status.

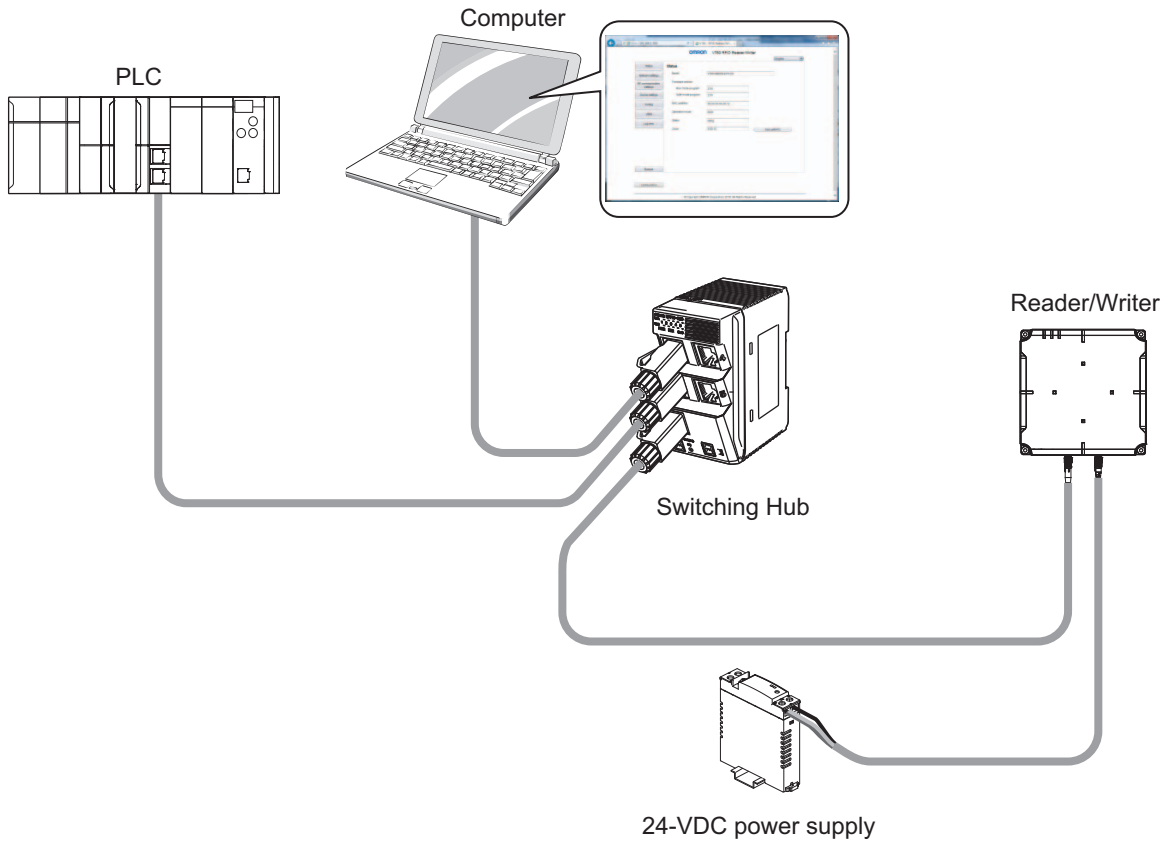

1-2 Application Flowchart

A simple application flowchart is provided below. For correct application methods and details, refer to the reference page or section given for each step.
 Also, use the *Startup Guide* provided with the Reader/Writer to help you start operation.
 When using the slave reader/writer, the procedure is slightly different.
 For details, see the startup guide for slave reader/writer.

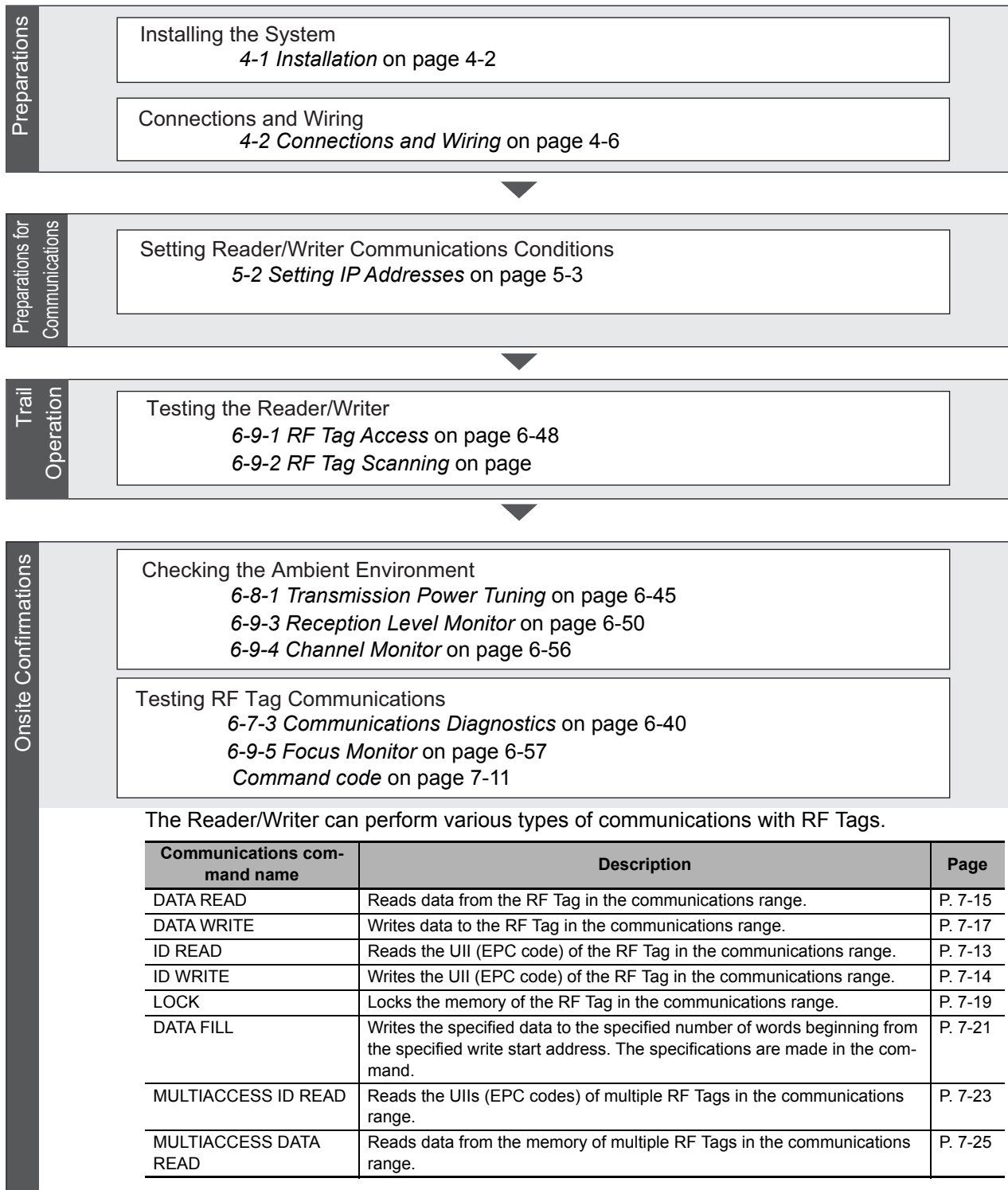

1-3 Reader/Writer Specifications

1-3-1 Appearance

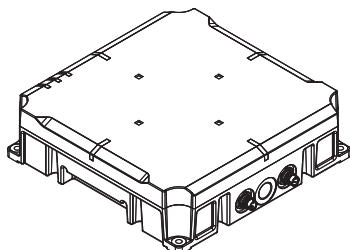

1-3-2 General Specifications

Item	V780-HMD68-EIP-□□	V780-HMD68-ETN-□□-S
Dimensions	250 × 250 × 70 mm (W × H × D, excluding protruding parts and cables)	
Supply voltage	24 VDC (−15% to +10%)	
Power consumption	10 W max.	
Ambient operating temperature	−10 to 55°C (with no icing)	
Ambient operating humidity	25% to 85% (with no condensation)	
Ambient storage temperature	−25 to 70°C (with no icing)	
Ambient storage humidity	25% to 85% (with no condensation)	
Insulation resistance	20 MΩ min. (at 500 VDC) between cable terminals and case	
Dielectric strength	1,000 VAC, 50/60 Hz for 1 min between cable terminals and case	
Vibration resistance	No abnormality after application of 10 to 500 Hz, double amplitude: 1.5 mm, acceleration: 100 m/s ² , 10 sweeps in each of 3 axis directions (up/down, left/right, and forward/backward) for 11 minutes each	
Shock resistance	No abnormality after application of 500 m/s ² , 3 times each in 6 directions (Total: 18 times)	
Degree of protection	IP54 (IEC 60529:2001)	
Materials	Plastic case: PBT Metal case: Die-cast aluminum (ADC12)	
Weight	Approx. 3 kg	
Mounting method	Four M6 bolts	
Host communications interface	Ethernet 10BASE-T/100BASE-TX	
Host communications protocol	EtherNet/IP	Multi-Reader/Writer Function only* ¹
Accessories	Instruction Sheet (1), IP address label (1), Startup Guide (1), Ferrite core (2)* ² , and EUDECLARATION OF CONFORMITY (1)* ³	
Regulations	See <i>Regulations</i> on page 1-7 for the regulations.	

*1. 1. Communication is performed only via the master reader/writer (model V780-HMD68-ETN-□□). It can not be controlled from a host device such as PLC. But web server function is available.

*2. A ferrite core is packaged with Model V780-HMD68-EIP-IN/EU/RU, and V780-HMD68-ETN-IN-S/EU-S/RU-S.

*3. A EU DECLARATION OF CONFORMITY is packaged with Model V780-HMD68-EIP-EU, and V780-HMD68-ETN-EU-S.

Regulations

Model	Regulations
V780-HMD68-EIP-JP V780-HMD68-ETN-JP-S	Premises Radio Station (920-MHz-band Moving Object Differentiation Wireless Facilities), ARIB STD-T106
V780-HMD68-EIP-KR V780-HMD68-ETN-KR-S	무선설비규칙
V780-HMD68-EIP-CN V780-HMD68-ETN-CN-S	Ministry of Information Industry No. 205 (2007)
V780-HMD68-EIP-TW V780-HMD68-ETN-TW-S	NCC LP0002 4.8 RFID
V780-HMD68-EIP-IN V780-HMD68-ETN-IN-S	the G.S.R.36 (E)
V780-HMD68-EIP-ID V780-HMD68-ETN-ID-S	PERDIRJEN POSTEL Nomor: 221/DIRJEN/2007
V780-HMD68-EIP-MY V780-HMD68-ETN-MY-S	MCMC MTSFB TC T007:2014
V780-HMD68-EIP-SG V780-HMD68-ETN-SG-S	Singapore : IMDA TS SRD2 Thailand : NTC TS 1010-2550 (RFID 920-925 MHz)
V780-HMD68-EIP-EU V780-HMD68-ETN-EU-S	2014/53EU (RE Directive)
V780-HMD68-EIP-RU V780-HMD68-ETN-RU-S	к решению ГКПЧ от 07.05.2007 № 07-20-03-001
V780-HMD68-EIP-US V780-HMD68-ETN-US-S	FCC 15.247 (United states) ISED RSS-247 (Canada)
V780-HMD68-EIP-MX V780-HMD68-ETN-MX-S	IFT-008 MYCE NOM-208

1-3-3 Tag Communications Specifications

V780-HMD68-EIP-JP/V780-HMD68-ETN-JP-S

	Item	V780-HMD68-EIP-JP/V780-HMD68-ETN-JP-S
Tag Communications Specifications	Applicable countries	Japan
	Maximum Radiated power	4 W e.i.r.p
	Output power	15 to 27 dBm (Switchable in 1-dB increments.)
	RSSI detection range	Signal level: -35 to -61 dBm Noise level: -35 to -70 dBm (at end of antenna cable)
	Transmission speed from Reader/Writer to RF Tag	40 kbps (fixed)
	Transmission speed from RF Tag to Reader/Writer	<ul style="list-style-type: none"> • 80 kbps (High-speed Mode)^{*1} • 20 kbps (Standard Mode)^{*1}
	Used frequencies (Described at the center frequency of each channel)	3 channels (916.8/918.0/919.2 MHz) License
	Channel interval	200 kHz
	Communications method with RF Tags	Miller-modulated subcarrier
	Tag communications protocol	ISO/IEC 18000-63: 2013 (EPCglobal Class-1 Generation-2)
	Polarization characteristic	RHCP
	Multiaccess communications	Up to 64 RF Tags can be read.

*1. The default setting is for Automatic Mode. The Reader/Writer will automatically change to High-speed Mode or Standard Mode depending on the interference waves.

V780-HMD68-EIP-KR/V780-HMD68-ETN-KR-S

	Item	V780-HMD68-EIP-KR/V780-HMD68-ETN-KR-S
Tag Communications Specifications	Applicable countries	Korea
	Maximum Radiated power	4 W e.i.r.p
	Output power	15 to 27 dBm (Switchable in 1-dB increments.)
	RSSI detection range	Signal level: -35 to -61 dBm Noise level: -35 to -70 dBm (at end of antenna cable)
	Transmission speed from Reader/Writer to RF Tag	40 kbps (fixed)
	Transmission speed from RF Tag to Reader/Writer	<ul style="list-style-type: none"> • 80 kbps (High-speed Mode)^{*1} • 31.25 kbps (Standard Mode)^{*1}
	Used frequencies	6 channels (917.3/917.9/918.5/919.1/919.7/920.3 MHz) FHSS
	Channel interval	200 kHz
	Communications method with RF Tags	Miller-modulated subcarrier
	Tag communications protocol	ISO/IEC 18000-63: 2013 (EPCglobal Class-1 Generation-2)
	Polarization characteristic	RHCP
	Multiaccess communications	Up to 64 RF Tags can be read.

*1. The default setting is for Automatic Mode. The Reader/Writer will automatically change to High-speed Mode or Standard Mode depending on the interference waves.

V780-HMD68-EIP-CN/V780-HMD68-ETN-CN-S

	Item	V780-HMD68-EIP-CN/V780-HMD68-ETN-CN-S
Tag Communications Specifications	Applicable countries	China
	Maximum Radiated power	2 W e.r.p
	Output power	15 to 27 dBm (Switchable in 1-dB increments.)
	RSSI detection range	Signal level: -35 to -61 dBm Noise level: -35 to -70 dBm (at end of antenna cable)
	Transmission speed from Reader/Writer to RF Tag	40 kbps (fixed)
	Transmission speed from RF Tag to Reader/Writer	<ul style="list-style-type: none"> • 80 kbps (High-speed Mode)^{*1} • 20 kbps (Standard Mode)^{*1}
	Used frequencies	16 channels (920.625 to 924.375 MHz) FHSS
	Channel interval	250 kHz
	Communications method with RF Tags	Miller-modulated subcarrier
	Tag communications protocol	ISO/IEC 18000-63: 2013 (EPCglobal Class-1 Generation-2)
	Polarization characteristic	RHCP
	Multiaccess communications	Up to 64 RF Tags can be read.

*1. The default setting is for Automatic Mode. The Reader/Writer will automatically change to High-speed Mode or Standard Mode depending on the interference waves.

V780-HMD68-EIP-TW/V780-HMD68-ETN-TW-S

	Item	V780-HMD68-EIP-TW/V780-HMD68-ETN-TW-S
Tag Communications Specifications	Applicable countries	Taiwan
	Maximum Radiated power	4 W e.i.r.p (Indoor use only)
	Output power	15 to 27 dBm (Switchable in 1-dB increments.)
	RSSI detection range	Signal level: -35 to -61 dBm Noise level: -35 to -70 dBm (at end of antenna cable)
	Transmission speed from Reader/Writer to RF Tag	40 kbps (fixed)
	Transmission speed from RF Tag to Reader/Writer	<ul style="list-style-type: none"> • 80 kbps (High-speed Mode)^{*1} • 31.25 kbps (Standard Mode)^{*1}
	Used frequencies	10 channels (922.75 to 927.25 MHz) FHSS
	Channel interval	500 kHz
	Communications method with RF Tags	Miller-modulated subcarrier
	Tag communications protocol	ISO/IEC 18000-63: 2013 (EPCglobal Class-1 Generation-2)
	Polarization characteristic	RHCP
	Multiaccess communications	Up to 64 RF Tags can be read.

*1. The default setting is for Automatic Mode. The Reader/Writer will automatically change to High-speed Mode or Standard Mode depending on the interference waves.

V780-HMD68-EIP-IN/V780-HMD68-ETN-IN-S

Item		V780-HMD68-EIP-IN/V780-HMD68-ETN-IN-S
Tag Communications Specifications	Applicable countries	India
	Maximum Radiated power	2 W e.r.p
	Output power	15 to 27 dBm (Switchable in 1-dB increments.)
	RSSI detection range	Signal level: -35 to -61 dBm Noise level: -35 to -70 dBm (at end of antenna cable)
	Transmission speed from Reader/Writer to RF Tag	40 kbps (fixed)
	Transmission speed from RF Tag to Reader/Writer	<ul style="list-style-type: none"> • 80 kbps (High-speed Mode)^{*1} • 31.25 kbps (Standard Mode)^{*1}
	Used frequencies	3 channels (865.7/866.3/866.9 MHz) FHSS
	Channel interval	200 kHz
	Communications method with RF Tags	Miller-modulated subcarrier
	Tag communications protocol	ISO/IEC 18000-63: 2013 (EPCglobal Class-1 Generation-2)
	Polarization characteristic	RHCP
Multiaccess communications	Up to 64 RF Tags can be read.	

*1. The default setting is for Automatic Mode. The Reader/Writer will automatically change to High-speed Mode or Standard Mode depending on the interference waves.

V780-HMD68-EIP-ID/V780-HMD68-ETN-ID-S

Item		V780-HMD68-EIP-ID/V780-HMD68-ETN-ID-S
Tag Communications Specifications	Applicable countries	Indonesia
	Maximum Radiated power	2 W e.r.p
	Output power	15 to 27 dBm (Switchable in 1-dB increments.)
	RSSI detection range	Signal level: -35 to -61 dBm Noise level: -35 to -70 dBm (at end of antenna cable)
	Transmission speed from Reader/Writer to RF Tag	40 kbps (fixed)
	Transmission speed from RF Tag to Reader/Writer	<ul style="list-style-type: none"> • 80 kbps (High-speed Mode)^{*1} • 31.25 kbps (Standard Mode)^{*1}
	Used frequencies	4 channels (923.25/923.75/924.25/924.75 MHz) FHSS
	Channel interval	500 kHz
	Communications method with RF Tags	Miller-modulated subcarrier
	Tag communications protocol	ISO/IEC 18000-63: 2013 (EPCglobal Class-1 Generation-2)
	Polarization characteristic	RHCP
Multiaccess communications	Up to 64 RF Tags can be read.	

*1. The default setting is for Automatic Mode. The Reader/Writer will automatically change to High-speed Mode or Standard Mode depending on the interference waves.

V780-HMD68-EIP-MY/V780-HMD68-ETN-MY-S

	Item	V780-HMD68-EIP-MY/V780-HMD68-ETN-MY-S
Tag Communications Specifications	Applicable countries	Malaysia
	Maximum Radiated power	2 W e.r.p
	Output power	15 to 27 dBm (Switchable in 1-dB increments.)
	RSSI detection range	Signal level: -35 to -61 dBm Noise level: -35 to -70 dBm (at end of antenna cable)
	Transmission speed from Reader/Writer to RF Tag	40 kbps (fixed)
	Transmission speed from RF Tag to Reader/Writer	<ul style="list-style-type: none"> • 80 kbps (High-speed Mode)^{*1} • 31.25 kbps (Standard Mode)^{*1}
	Used frequencies	8 channels (919.25 to 922.75 MHz) FHSS
	Channel interval	500 kHz
	Communications method with RF Tags	Miller-modulated subcarrier
	Tag communications protocol	ISO/IEC 18000-63: 2013 (EPCglobal Class-1 Generation-2)
	Polarization characteristic	RHCP
	Multiaccess communications	Up to 64 RF Tags can be read.

*1. The default setting is for Automatic Mode. The Reader/Writer will automatically change to High-speed Mode or Standard Mode depending on the interference waves.

V780-HMD68-EIP-SG/V780-HMD68-ETN-SG-S

	Item	V780-HMD68-EIP-SG/V780-HMD68-ETN-SG-S
Tag Communications Specifications	Applicable countries	Singapore and Thailand
	Maximum Radiated power	2 W e.r.p
	Output power	15 to 27 dBm (Switchable in 1-dB increments.)
	RSSI detection range	Signal level: -35 to -61 dBm Noise level: -35 to -70 dBm (at end of antenna cable)
	Transmission speed from Reader/Writer to RF Tag	40 kbps (fixed)
	Transmission speed from RF Tag to Reader/Writer	<ul style="list-style-type: none"> • 80 kbps (High-speed Mode)^{*1} • 31.25 kbps (Standard Mode)^{*1}
	Used frequencies	8 channels (920.75 to 924.25 MHz) FHSS
	Channel interval	500 kHz
	Communications method with RF Tags	Miller-modulated subcarrier
	Tag communications protocol	ISO/IEC 18000-63: 2013 (EPCglobal Class-1 Generation-2)
	Polarization characteristic	RHCP
	Multiaccess communications	Up to 64 RF Tags can be read.

*1. The default setting is for Automatic Mode. The Reader/Writer will automatically change to High-speed Mode or Standard Mode depending on the interference waves.

V780-HMD68-EIP-EU/V780-HMD68-ETN-EU-S

	Item	V780-HMD68-EIP-EU/V780-HMD68-ETN-EU-S
Tag Communications Specifications	Applicable countries	Under RE direct
	Maximum Radiated power	2 W e.r.p
	Output power	15 to 27 dBm (Switchable in 1-dB increments.)
	RSSI detection range	Signal level: -35 to -61 dBm Noise level: -35 to -70 dBm (at end of antenna cable)
	Transmission speed from Reader/Writer to RF Tag	40 kbps (fixed)
	Transmission speed from RF Tag to Reader/Writer	<ul style="list-style-type: none"> • 80 kbps (High-speed Mode)^{*1} • 31.25 kbps (Standard Mode)^{*1}
	Used frequencies	4 channels (865.7/866.3/866.9/867.5 MHz) FHSS
	Channel interval	200 kHz
	Communications method with RF Tags	Miller-modulated subcarrier
	Tag communications protocol	ISO/IEC 18000-63: 2013 (EPCglobal Class-1 Generation-2)
	Polarization characteristic	RHCP
Multiaccess communications	Up to 64 RF Tags can be read.	

*1. The default setting is for Automatic Mode. The Reader/Writer will automatically change to High-speed Mode or Standard Mode depending on the interference waves.

V780-HMD68-EIP-RU/V780-HMD68-ETN-RU-S

	Item	V780-HMD68-EIP-RU/V780-HMD68-ETN-RU-S
Tag Communications Specifications	Applicable countries	Russia
	Maximum Radiated power	2 W e.r.p
	Output power	15 to 27 dBm (Switchable in 1-dB increments.)
	RSSI detection range	Signal level: -35 to -61 dBm Noise level: -35 to -70 dBm (at end of antenna cable)
	Transmission speed from Reader/Writer to RF Tag	40 kbps (fixed)
	Transmission speed from RF Tag to Reader/Writer	<ul style="list-style-type: none"> • 80 kbps (High-speed Mode)^{*1} • 31.25 kbps (Standard Mode)^{*1}
	Used frequencies	3 channels (866.3/866.9/867.5 MHz) FHSS
	Channel interval	200 kHz
	Communications method with RF Tags	Miller-modulated subcarrier
	Tag communications protocol	ISO/IEC 18000-63: 2013 (EPCglobal Class-1 Generation-2)
	Polarization characteristic	RHCP
Multiaccess communications	Up to 64 RF Tags can be read.	

*1. The default setting is for Automatic Mode. The Reader/Writer will automatically change to High-speed Mode or Standard Mode depending on the interference waves.

V780-HMD68-EIP-US/V780-HMD68-ETN-US-S

	Item	V780-HMD68-EIP-US/V780-HMD68-ETN-US-S
Tag Communications Specifications	Applicable countries	United States and Canada
	Maximum Radiated power	4 W e.i.r.p
	Output power	15 to 27 dBm (Switchable in 1-dB increments.)
	RSSI detection range	Signal level: -35 to -61 dBm Noise level: -35 to -70 dBm (at end of antenna cable)
	Transmission speed from Reader/Writer to RF Tag	40 kbps (fixed)
	Transmission speed from RF Tag to Reader/Writer	<ul style="list-style-type: none"> • 80 kbps (High-speed Mode)^{*1} • 31.25 kbps (Standard Mode)^{*1}
	Used frequencies	50 channels (902.75 to 927.25 MHz) FHSS
	Channel interval	500 kHz
	Communications method with RF Tags	Miller-modulated subcarrier
	Tag communications protocol	ISO/IEC 18000-63: 2013 (EPCglobal Class-1 Generation-2)
	Polarization characteristic	RHCP
	Multiaccess communications	Up to 64 RF Tags can be read.

*1. The default setting is for Automatic Mode. The Reader/Writer will automatically change to High-speed Mode or Standard Mode depending on the interference waves.

V780-HMD68-EIP-MX/V780-HMD68-ETN-MX-S

	Item	V780-HMD68-EIP-MX/V780-HMD68-ETN-MX-S
Tag Communications Specifications	Applicable countries	Mexico
	Maximum Radiated power	4 W e.i.r.p
	Output power	15 to 27 dBm (Switchable in 1-dB increments.)
	RSSI detection range	Signal level: -35 to -61 dBm Noise level: -35 to -70 dBm (at end of antenna cable)
	Transmission speed from Reader/Writer to RF Tag	40 kbps (fixed)
	Transmission speed from RF Tag to Reader/Writer	<ul style="list-style-type: none"> • 80 kbps (High-speed Mode)^{*1} • 31.25 kbps (Standard Mode)^{*1}
	Used frequencies	50 channels (902.75 to 927.25 MHz) FHSS
	Channel interval	500 kHz
	Communications method with RF Tags	Miller-modulated subcarrier
	Tag communications protocol	ISO/IEC 18000-63: 2013 (EPCglobal Class-1 Generation-2)
	Polarization characteristic	RHCP
	Multiaccess communications	Up to 64 RF Tags can be read.

*1. The default setting is for Automatic Mode. The Reader/Writer will automatically change to High-speed Mode or Standard Mode depending on the interference waves.

1-3-4 Recommended Power Supply (24 VDC)

Item	Condition
Supply voltage	24 VDC -15% to +10%
Output current	500 mA min.
Safety standard	SELV (Safety Extra Low Voltage)

1-3-5 Dimensions

(Unit: mm)

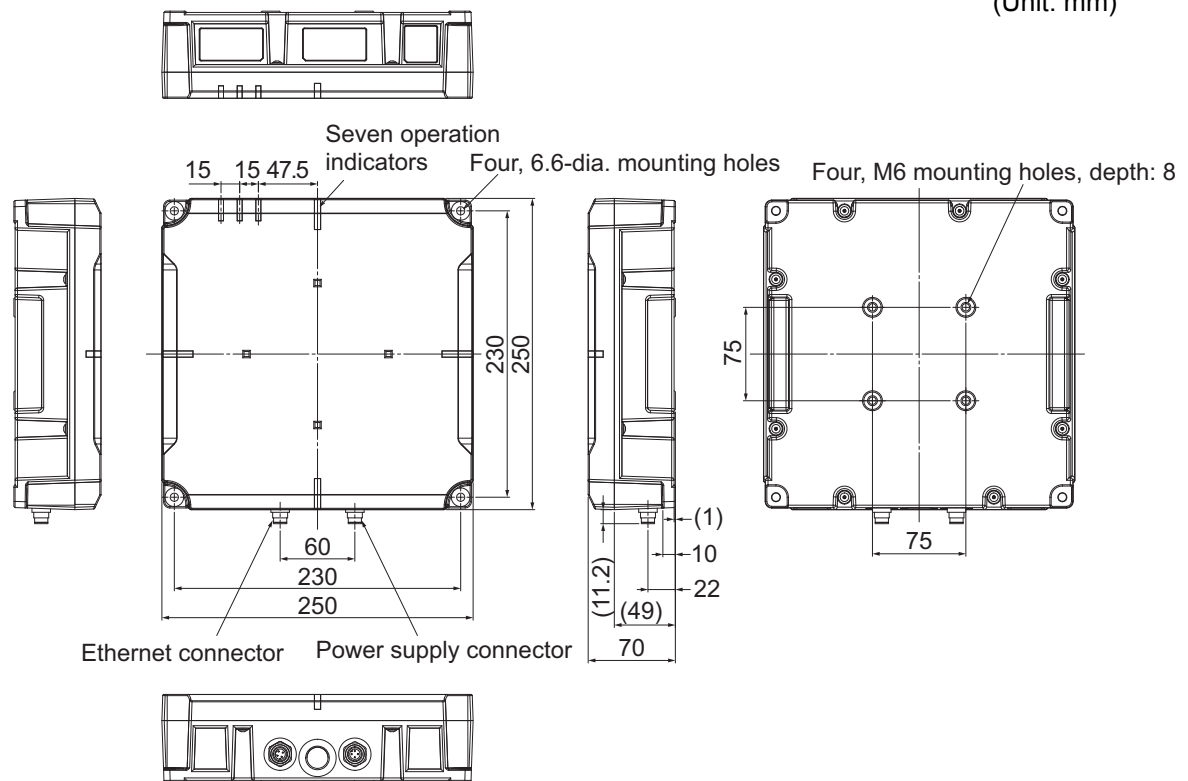

1-4 RF Tag Specifications

V780-A-JIME-Z3BLI-10*¹ RF Tags (Recommended)

- Appearance

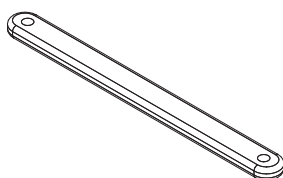

- OMRON Model Number: V780-A-JIME-Z3BLI-10*¹

- General Specifications

Item	V780-A-JIME-Z3BLI-10* ¹ (made by Toppan Forms Co., Ltd.)
Dimensions	150 × 14 × 6 mm (W × H × D)
IC chip, memory	Monza X 8K UII (EPC): 128 bits User memory: 8,192 bits
Write life / Data retention	10,000 writes / 10 years
	100,000 writes / 1 year
Operating temperature	-20 to 65°C
Operating humidity	5% to 95%
Storage temperature	-30 to 70°C
Storage humidity	5% to 95%
Material	Polycarbonate plastic
Weight	Tag: Approx. 15 g
Degree of protection	IP68 (IEC 60529: 2001)



Precautions for Correct Use

The marked surface is the communications surface. When mounting an RF Tag, face the marked surface toward the Reader/Writer.

- Dimensions

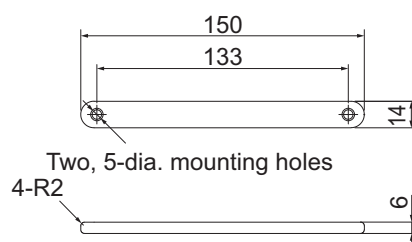

(Unit: mm)

*1. This is the model number for one package of 10 RF Tags.
Order the number of packages that you require.

V780-A-TA-133-10*¹ Attachment (Recommended)

- Appearance

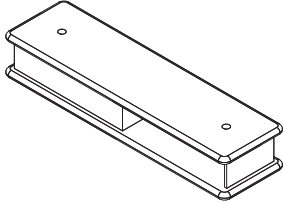

- OMRON Model Number: V780-A-TA-133-10*¹

- General Specifications

Item	V780-A-TA-133-10* ¹ (made by Toppan Forms Co., Ltd.)
Dimensions	180 × 50 × 30 mm (W × H × D)
Operating temperature	-20 to 65°C
Operating humidity	5% to 95%
Storage temperature	-30 to 70°C
Storage humidity	5% to 95%
Material	Polycarbonate plastic
Weight	Approx. 128 g

- Dimensions

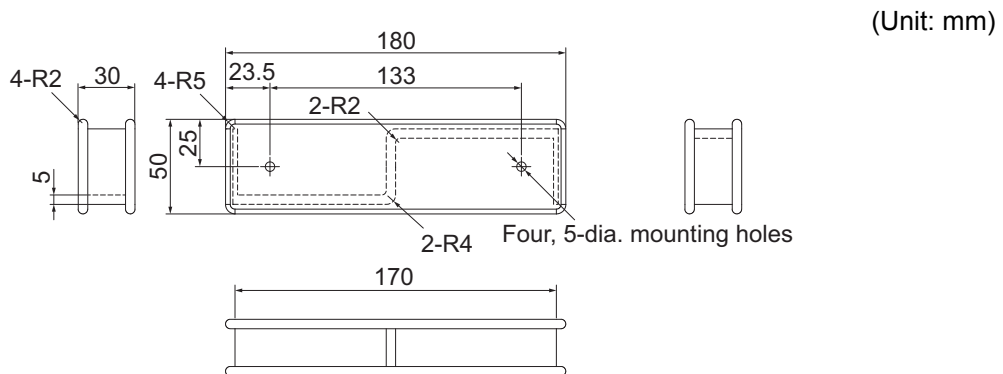

*1. This is the model number for one package of 10 RF Tags.
Order the number of packages that you require.



System Configuration

This section describes the system configuration that you can use for a V780 Reader/Writer.

2-1 RFID System Configuration 2-2

2-1 RFID System Configuration

The following four variations are possible in the RFID system configuration.

- Host device (e.g., PLC) with one Reader/Writer
- Host device (e.g., PLC) with multiple Reader/Writers
- Host device and a computer
- Connection to a workpiece detection sensor

Host Device (e.g., PLC) with One Reader/Writer

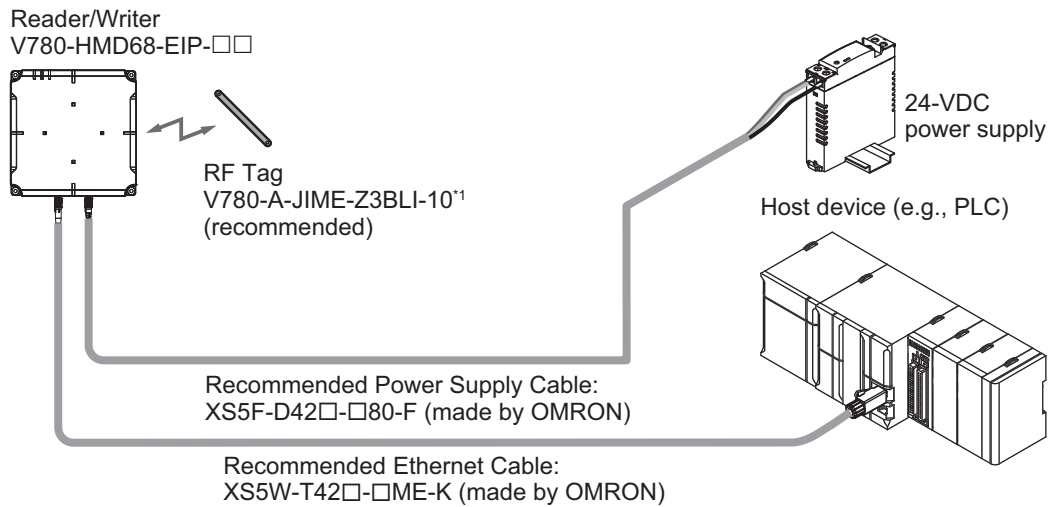

*1. This is the model number for one package of 10 RF Tags.
Order the number of packages that you require.

Host Device (e.g., PLC) with Multiple Reader/Writers

- When the multi reader/writer function is not used

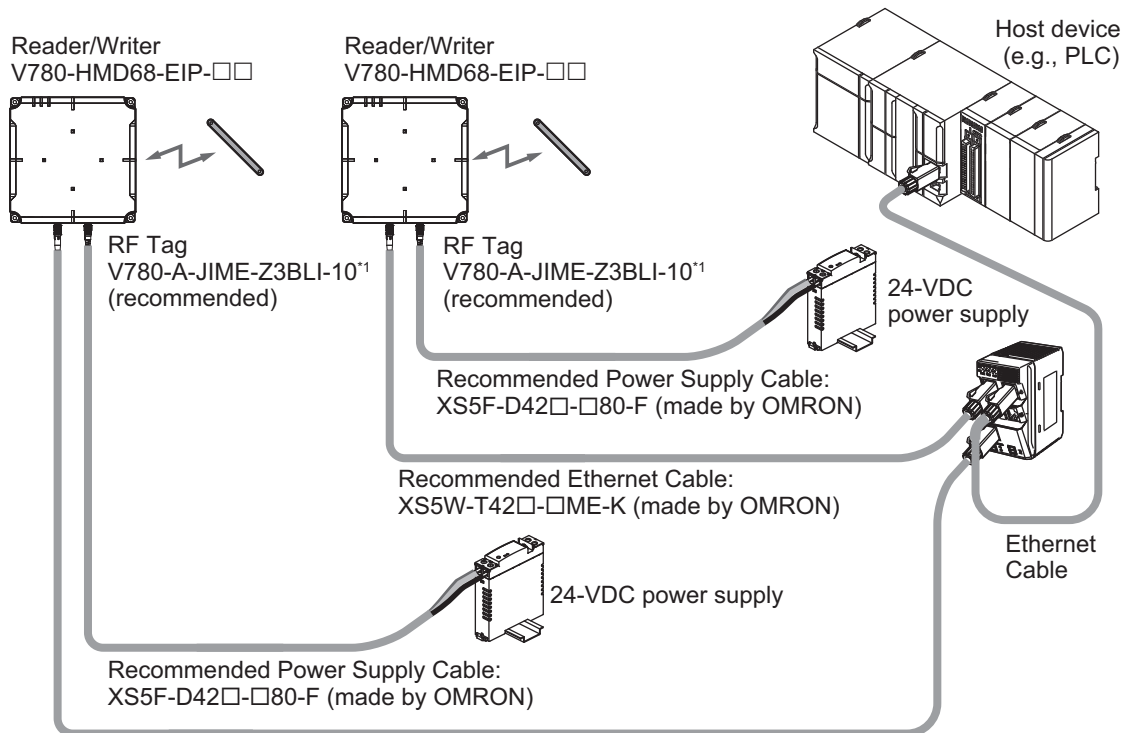

Recommended Ethernet Cable:
XS5W-T42□-□ME-K (made by OMRON)

*1. This is the model number for one package of 10 RF Tags.
Order the number of packages that you require.

● When the multi reader/writer function is used

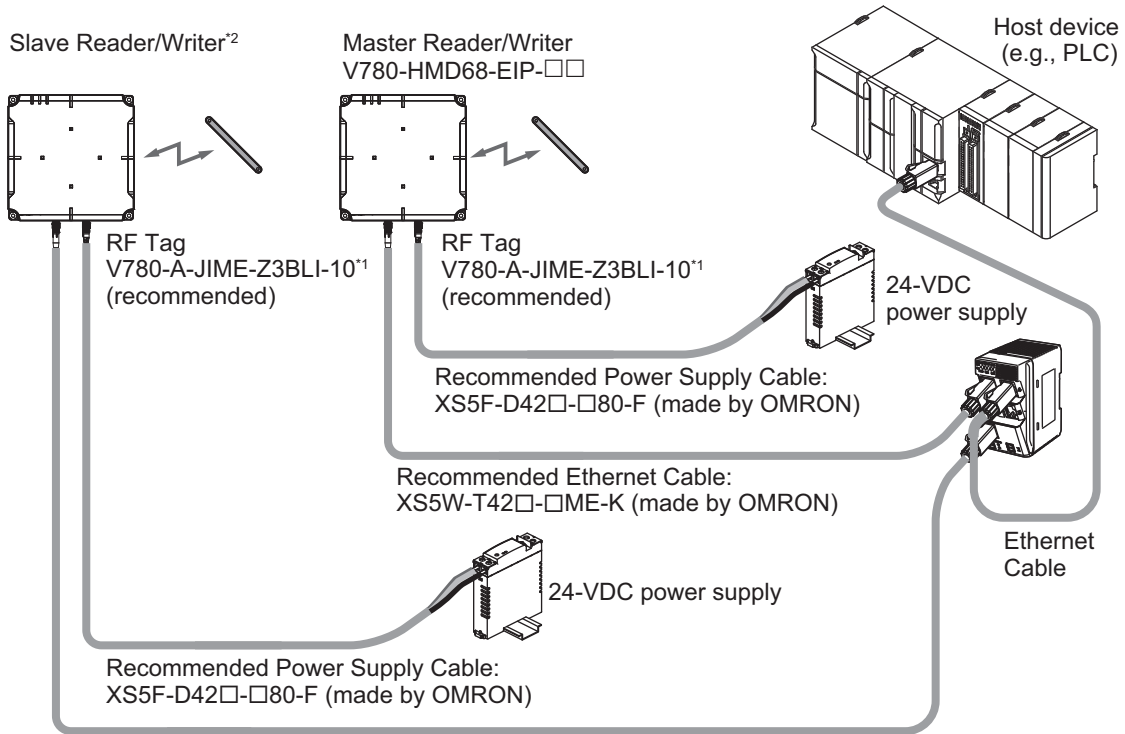

Recommended Ethernet Cable:
XS5W-T42□-□ME-K (made by OMRON)

*1. This is the model number for one package of 10 RF Tags.
Order the number of packages that you require.

*2. Communication is performed only via the master reader/writer. It can not be controlled from a host device such as PLC. But web server function is available.

Model		Slave Reader/Writer		
		V780-HMD68-ETN-□□ Standard Reader/Writer Modbus/TCP	V780-HMD68-EIP-□□ Standard Reader/Writer EtherNet/IP	V780-HMD68-ETN-□□-S Slave Reader/Writer Modbus/TCP
Master Reader/Writer	V780-HMD68-ETN-□□ Standard Reader/Writer Modbus/TCP	Available	Not available	Available
	V780-HMD68-EIP-□□ Standard Reader/Writer EtherNet/IP	Not available	Available	Available



Precautions for Correct Use

The slave reader/writer (V780-HMD68-ETN-□□- S) disconnects the connection when it sends a communication command directly from the host device such as PLC.

Use the slave reader/writer via the master reader/writer (V780-HMD68-EIP-□□).

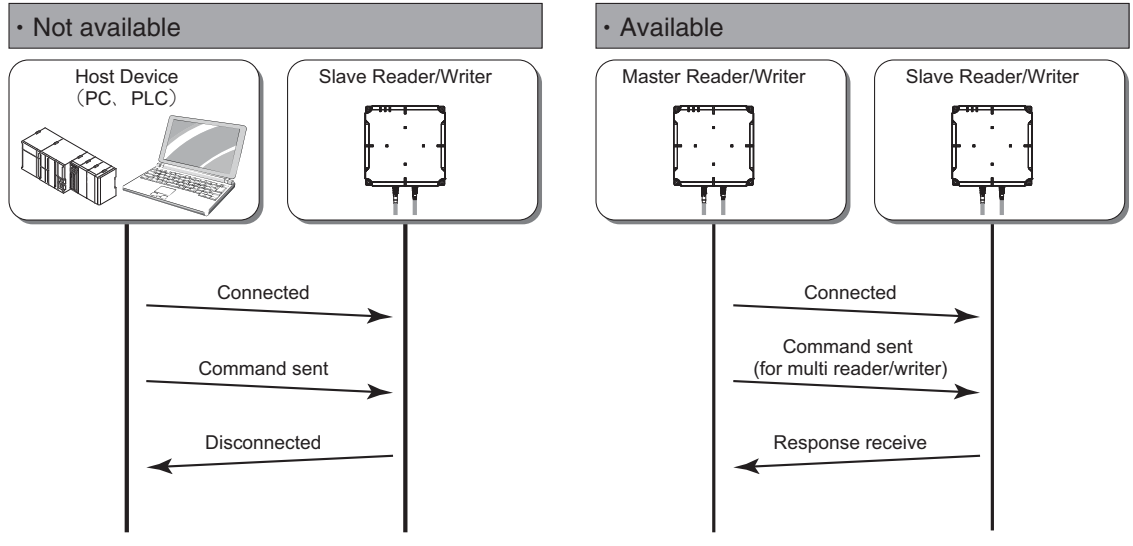

Host Device and a Computer

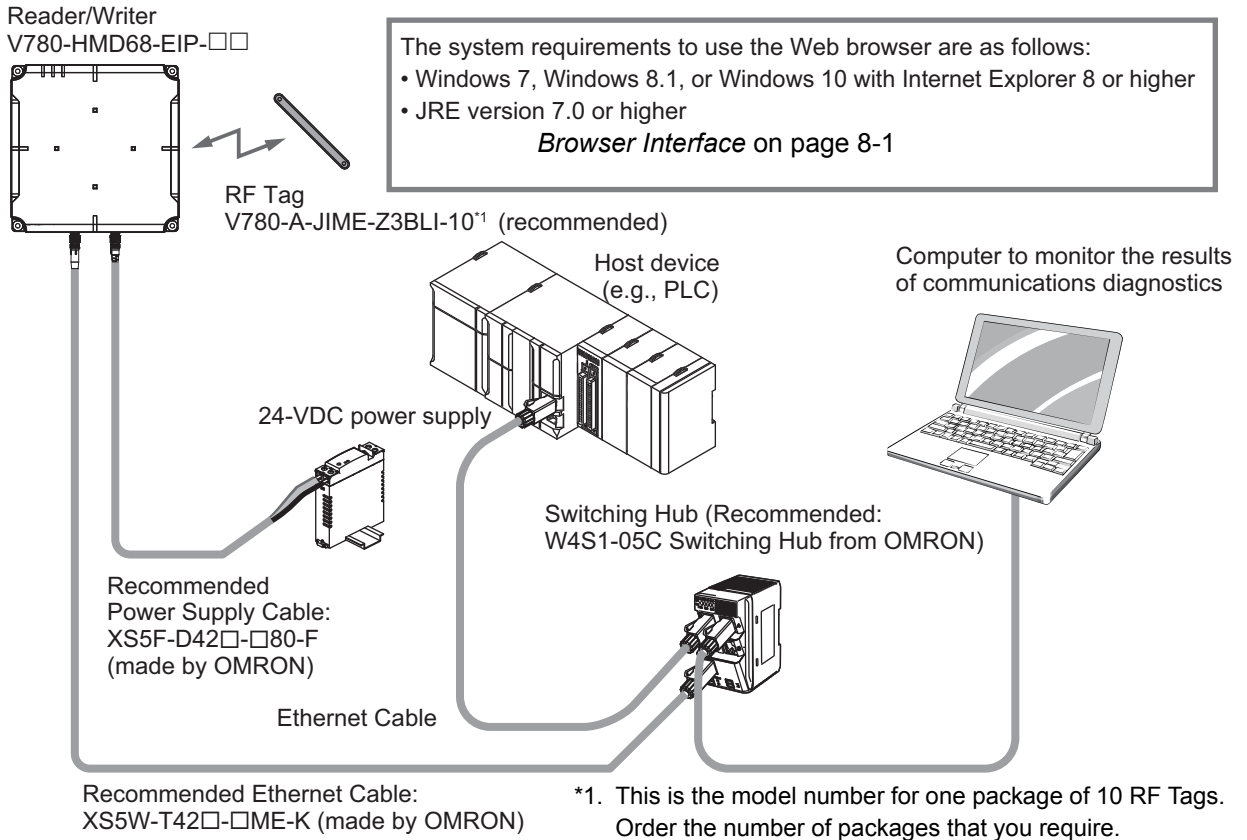

Connection to a Workpiece Detection Sensor

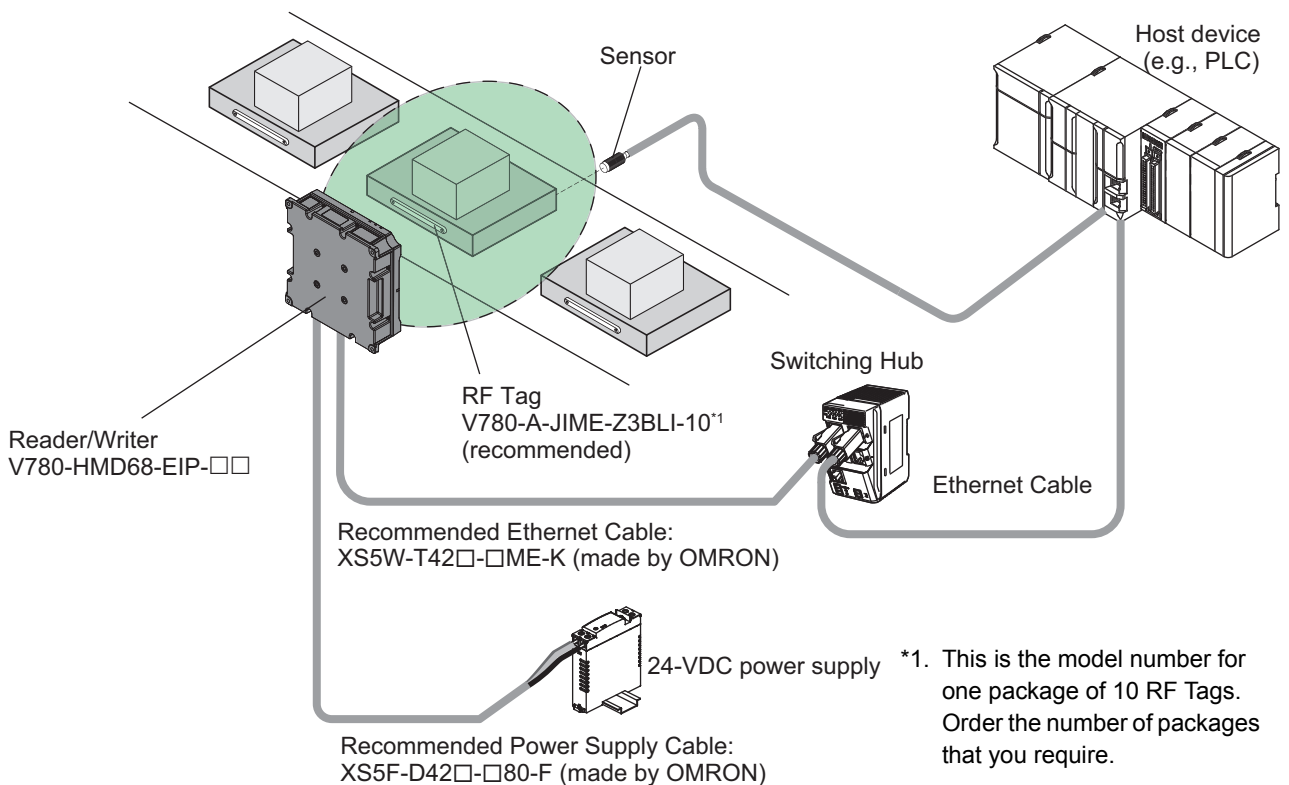



Precautions for Correct Use

- Ground the frame ground (GR) terminal on the power supply to 100 Ω or less. Otherwise, performance may deteriorate.
- The black wire in the Power Supply Cable (pin 4) is not used. Do not connect it to any terminal.
- To use the Reader/Writer in Run Mode, connect the control signal wire (white) to +24 VDC of the power supply. If you connect the control signal wire (white) to the 0-V side of the power supply, the Reader/Writer will start in Safe Mode.
- Connect a power supply that meets the following conditions to the Reader/Writer.

Item	Condition
Supply voltage	24 VDC -15% to $+10\%$
Output current	500 mA min.
Safety standard	SELV (Safety Extra Low Voltage)



Precautions for Correct Use

- The maximum total length of Ethernet Cable is 100 m.
 - The maximum total length of Power Supply Cable is 60 m.
 - Ask your OMRON representative for the recommended extension cables for the Ethernet Cable and Power Supply Cable.
-



Precautions for Safe Use

- Connect the Ethernet Cable to a host device (e.g., Switching Hub or PLC) that supports STP (shielded twisted-pair) and ground the host device to a ground resistance of 100 Ω or less.
-



Precautions for Correct Use

If you loop the Ethernet line, one broadcast packet may consume the entire bandwidth, preventing communications or possibly causing the Reader/Writer to stop operation. Do not create a loop in the Ethernet line when you connect it.

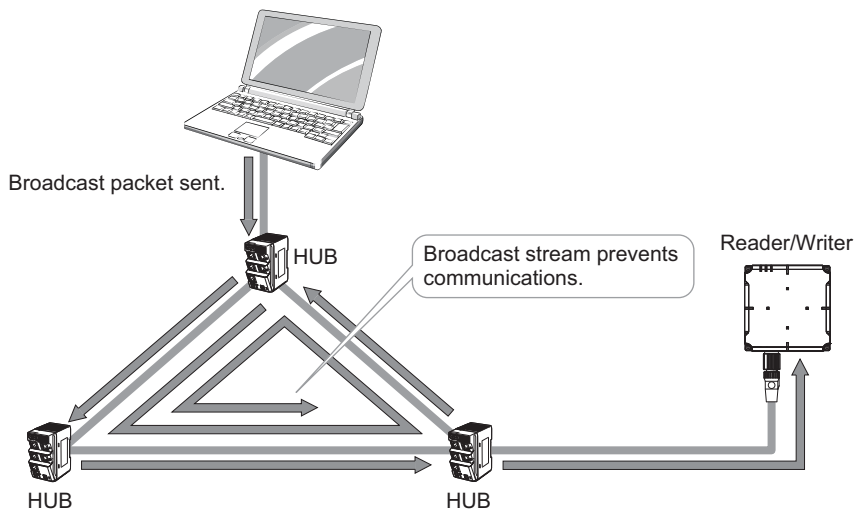

Also, if a large volume of broadcast packets or multicast packets are placed on the network, the Reader/Writer's response speed will drop and the Reader/Writer may even stop operating. Do not place a large volume of packets on the network in this way. Also, separate segments for the Reader/Writer from broadcast or multicast packets.

3

Part Names and Functions

This section describes the part names and functions of the V780 Reader/Writer.

3-1	Operation Indicators	3-2
3-1-1	Names and Descriptions of Operation Indicators	3-2
3-1-2	Operation Indicators at Startup	3-4
3-1-3	Operation Indicators for WDT Errors	3-5
3-1-4	Operation Indicators for IP Address Conflict	3-5
3-1-5	Operation Indicators When BOOTP Server Connection Fails	3-6
3-1-6	Operation Indicators during Command Execution	3-6
3-1-7	Operation Indicators during Test Execution	3-9
3-1-8	Operation Indicators for System Errors	3-10
3-1-9	Operation Indicators when a Timeout is Detected in a Tag Data Link	3-12
3-1-10	During Multi-Reader/Writer function use	3-13
3-2	Connectors	3-15

3-1 Operation Indicators







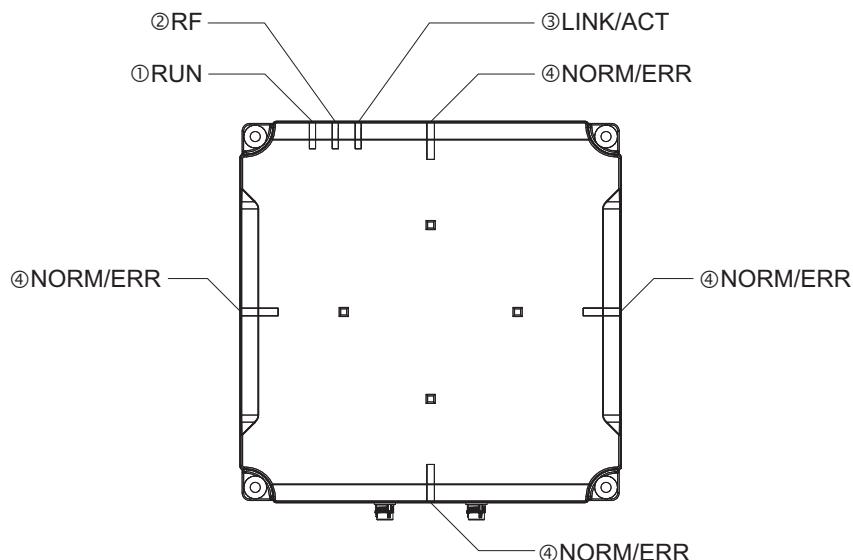



This section describes the operation indicators on the Reader/Writer.

3-1-1 Names and Descriptions of Operation Indicators

V780-HMD68-EIP-□□



Number and name	Color	Status	Description
①RUN	Green		Flashing at 0.1-s intervals Flashes rapidly during startup, or while waiting for the establishment of a connection of the tag data link from the originator.* ¹
			Flashing at 0.4-s intervals Flashes during operation in Safe Mode.
			Lit Lit during operation in Run Mode.
	Cyan		Lit Lit during test operation.* ²
	Yellow		Lit Lit during operation in SLAVE Mode.
	---		Not lit Not lit in the following cases. • When power is not being supplied • When there is a watchdog timer (WDT) error
②RF	Yellow		Lit Lit when a radio wave is being output. (Lit during communications with an RF Tag.)
			Not lit Not lit when a radio wave is not being output.
③LINK/ACT	Green		Lit Lit when a link has been established on the Ethernet port.
			Flashing irregularly Flashes during data communications on the Ethernet port.
			Not lit Not lit when a link has not been established on the Ethernet port.

Number and name	Color	Status	Description
④NORM/ ERR	Green		Lit for 0.2 s Lights once when processing a communications command or another command from the host device is completed normally. Flashes once each time a stable communication is detected while communications diagnosis is enabled.
			Lit for 0.2 s Flashes once each time an unstable communication is detected while communications diagnosis is enabled.
	Yellow		Lit for 0.1 s Flashes rapidly when a timeout is detected in a tag data link (when the tag data from the originator could not be received even after the lapse of the time specified by the timeout value).
			Lit for 0.2 s Lights once when processing a communications command or another command from the host device ends in an error.
	Red		Lit Lit when a major fault has occurred. (Lit when a fatal error has occurred.)
			Flashing at 0.4-s intervals Flashes when a minor fault has occurred. (Flashes when a nonfatal error has occurred.)
			Flashing irregularly twice Flashes when a minor fault has occurred. (When a duplicate IP address is detected during startup, or when an error is detected during acquisition of the IP address from the BOOTP server)
	Cyan		Flashing at 0.1-s intervals Flashes during installation location notification.
			Flashing once every 3 s Flashes during operation in the Focus Mode.
	---		Not lit Not lit when the Reader/Writer is on standby.

*1. This indicator flashes from startup until Run Mode or Save Mode is entered and during IP address queries when BOOTP is enabled.

*2. "During test operation" includes Web browser interface adjustment and execution of utility functions.

 **Precautions for Correct Use**

Refer to 9-1-1 *Errors Indicated on Operation Indicators* on page 9-2 for errors indicated by the operation indicators.

3-1-2 Operation Indicators at Startup

The Reader/Writer will start when you turn ON the power supply. The RUN indicator will flash at 0.1-s intervals while the Reader/Writer is starting.

IP address conflict detection will operate during Reader/Writer startup.

(If using the BOOTP client is enabled, detection will also operate during BOOTP server queries.)

The RUN indicator flashes green at 0.1-s intervals.
The LINK/ACT indicator does not light.

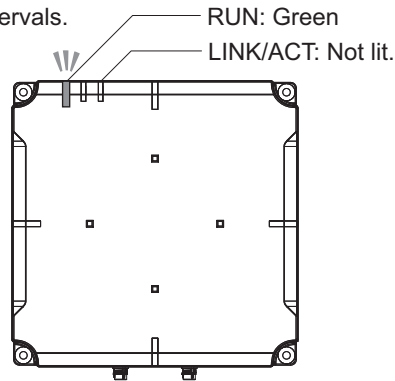

The RUN indicator lights when the Reader/Writer starts in Run Mode, and a connection of the tag data link from the originator is established.

The LINK/ACT indicator will light when a link is established between the Reader/Writer and the Ethernet port.

The RUN indicator lights green.
The LINK/ACT indicator lights green.

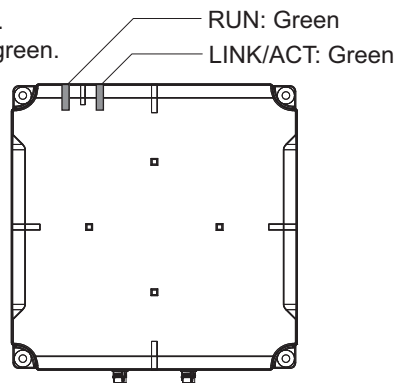

The RUN indicator will flash at 0.4-s intervals when the Reader/Writer starts in Safe Mode.

The LINK/ACT indicator will light when a link is established between the Reader/Writer and the Ethernet port.

The RUN indicator flashes green at 0.4-s intervals.
The LINK/ACT indicator lights green.

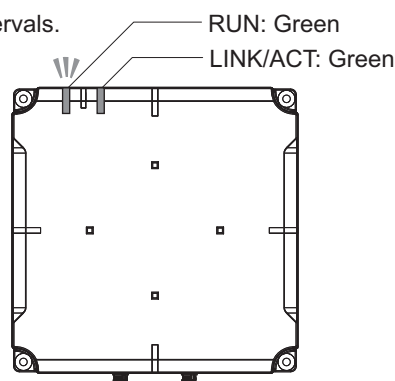

3-1-3 Operation Indicators for WDT Errors

If a WDT error is detected when the system runs out of control during operation, the RUN indicator will go out and the NORM/ERR indicators will light red.

This is a fatal error, so you must either restart or replace the Reader/Writer.

The RUN indicator does not light.
The NORM/ERR indicators light red.

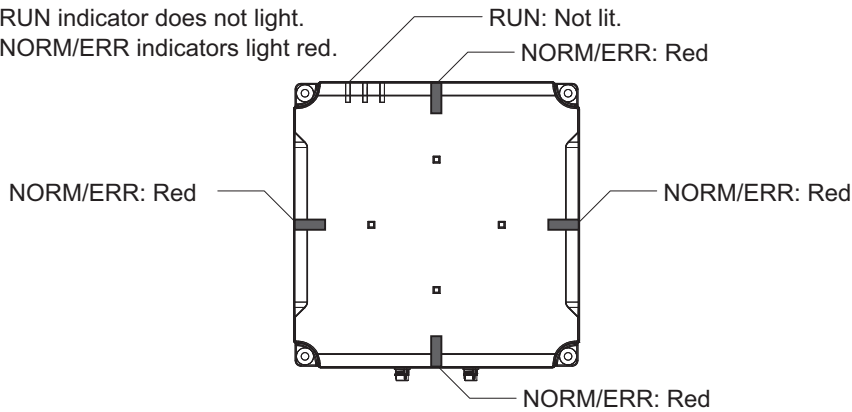

3-1-4 Operation Indicators for IP Address Conflict

IP address conflict detection will operate during Reader/Writer startup. The Reader/Writer conforms to RFC 5227 IP address conflict detection.

If the Reader/Writer detects another node with the same IP address on the same network, the NORM/ERR indicators will flash irregularly.

In this case, you must restart (i.e., cycle the power supply) the Reader/Writer to restore operation. IP address conflict detection does not operate while the Reader/Writer is in operation.

The RUN indicator flashes green at 0.1-s intervals.
The LINK/ACT indicator does not light.
The NORM/ERR indicators flash red irregularly (twice every second).

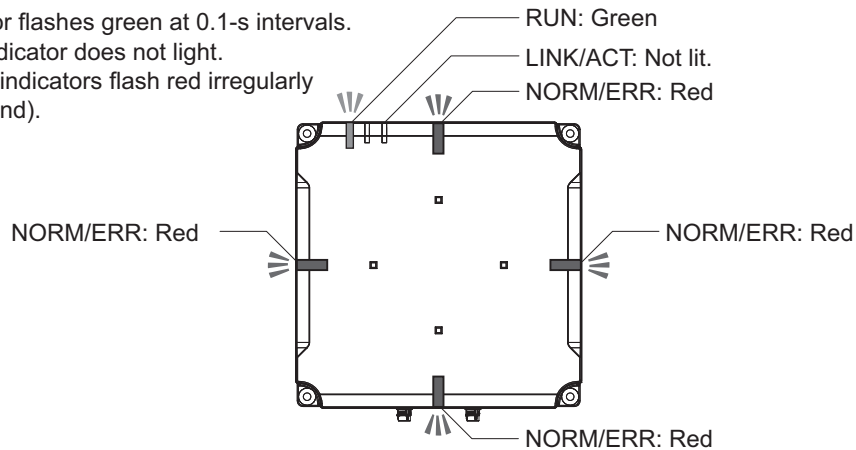

3-1-5 Operation Indicators When BOOTP Server Connection Fails

If using the BOOTP client is enabled, the Reader/Writer queries the BOOTP server at startup. If connecting to the server is not possible within a specific period of time or a suitable IP address is not available, the NORM/ERR indicators will flash irregularly.

The RUN indicator flashes green at 0.1-s intervals.
The NORM/ERR indicators flash red irregularly (twice every second).

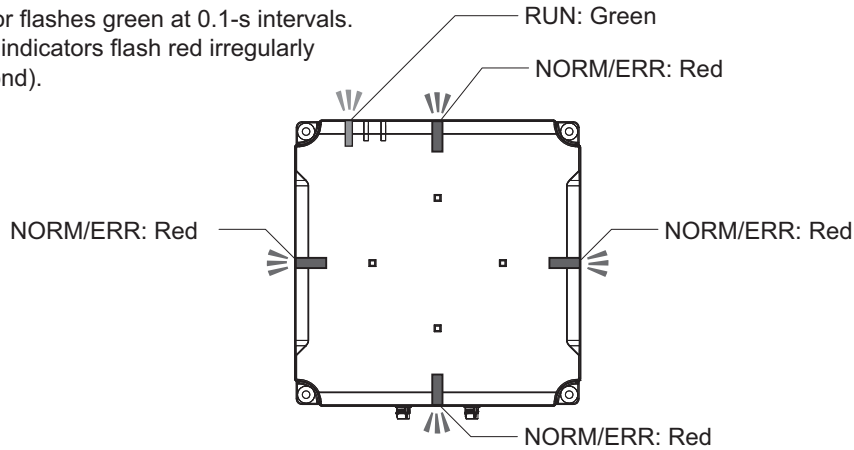

3-1-6 Operation Indicators during Command Execution

Communications Command Execution

The RF indicator will light yellow during communications between the Reader/Writer and RF Tag for execution of a command from the host device.

The RUN indicator lights green.
The RF indicator lights yellow.

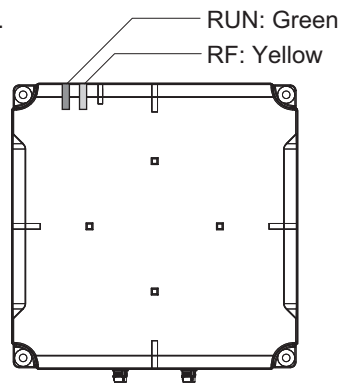

Normal Command Completion

The NORM/ERR indicators will flash green once when processing ends normally for execution of a command from the host device.

The RUN indicator lights green.
The NORM/ERR indicators flash green once.

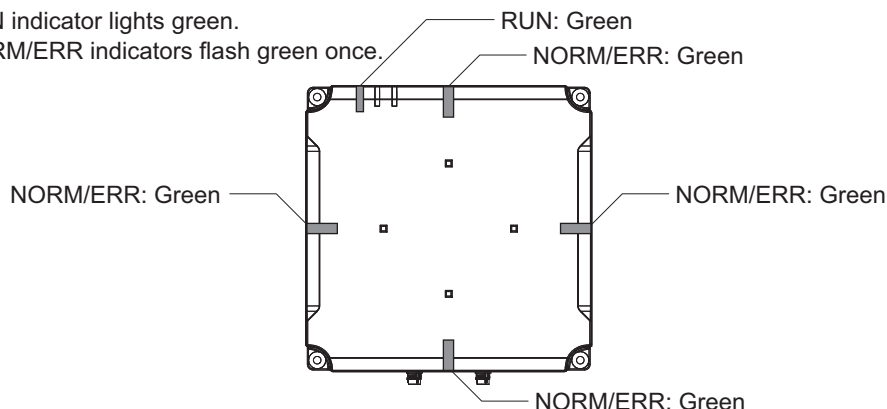

Normal Command Completion with Unstable Communications

The NORM/ERR indicators will flash yellow once when processing ends normally for execution of a command from the host device but the diagnosis results indicates unstable communications. The indication of unstable communications appears only when communications diagnosis is enabled.

The RUN indicator lights green.

The NORM/ERR indicators flash yellow once.

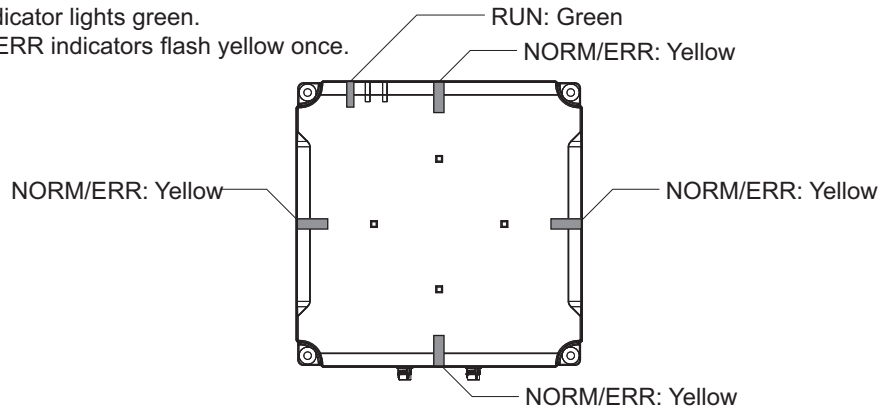

Error Command Completion

The NORM/ERR indicators will flash red once when processing ends in an error for execution of a command from the host device.

The RUN indicator lights green.

The NORM/ERR indicators flash red once.

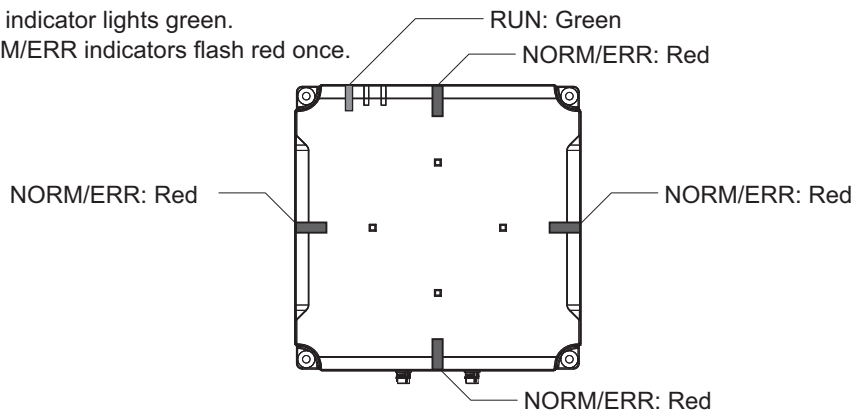

Operation Indicators during Focus Execution

The NORM/ERR indicators will flash cyan one time every three seconds and the RF indicator will light yellow during operation in Focus Mode. The NORM/ERR indicators will light green, yellow, or red according to the communications results of communications commands sent during Focus Mode.

The RUN indicator lights green.

The RF indicator lights yellow.

The LINK/ACT indicator does not light.

The NORM/ERR indicators flash cyan
(once every 3 s).

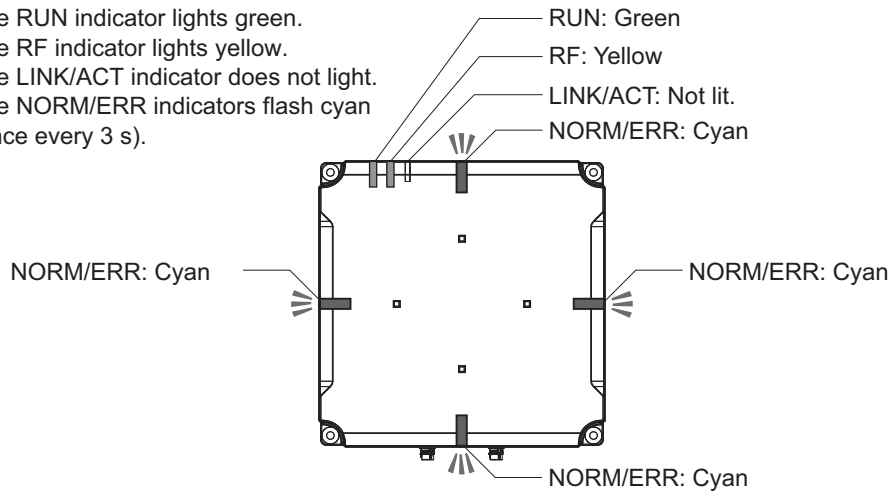

3-1-7 Operation Indicators during Test Execution

Test Execution

The RUN indicator will light cyan during execution of test functions from the Web browser interface.

The RUN indicator lights cyan.

The LINK/ACT indicator does not light.

The NORM/ERR indicators do not light.

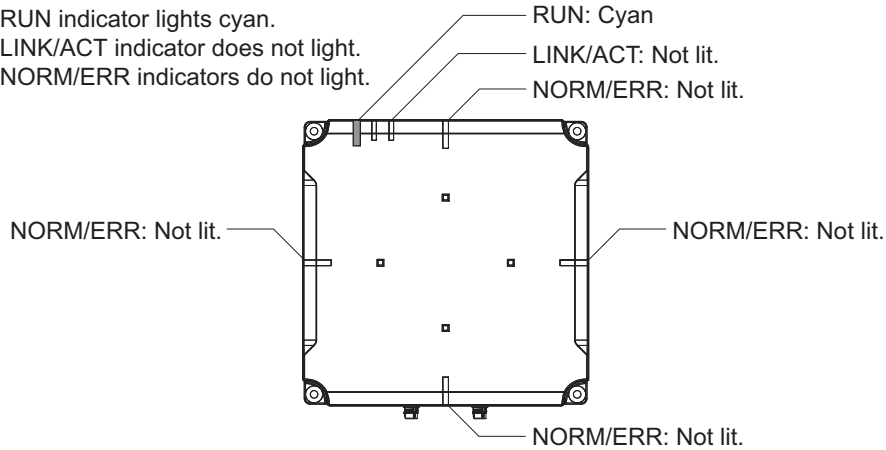

Operation Indicators during Single-access Communications for Reception Level Monitoring

The NORM/ERR indicators will flash according to the reception power of the RF Tag during single-access communications testing for the Reception Level Monitor of the Web browser interface.

The RUN indicator lights cyan.

The LINK/ACT indicator does not light.

The NORM/ERR indicators flash green at 0.4-s intervals.

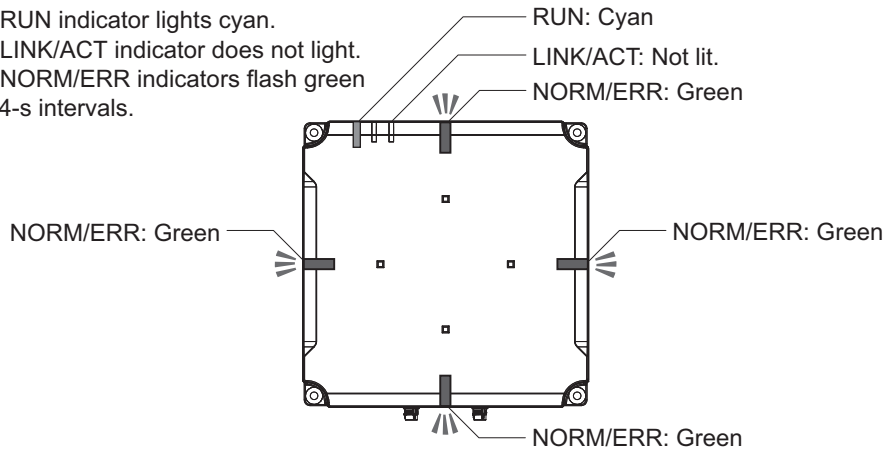

3-1-8 Operation Indicators for System Errors

Minor Faults

If a minor fault is detected, the NORM/ERR indicators will flash red at 0.4-second intervals.

To recover normal operation, initialize the Reader/Writer settings and then restart the Reader/Writer.

However, if an illegal network setting or an incorrect operating mode is detected during operation, the RUN indicator will flash red and the Reader/Writer will start in Safe Mode.

The RUN indicator lights green.

The NORM/ERR indicators flash red at 0.4-s intervals.

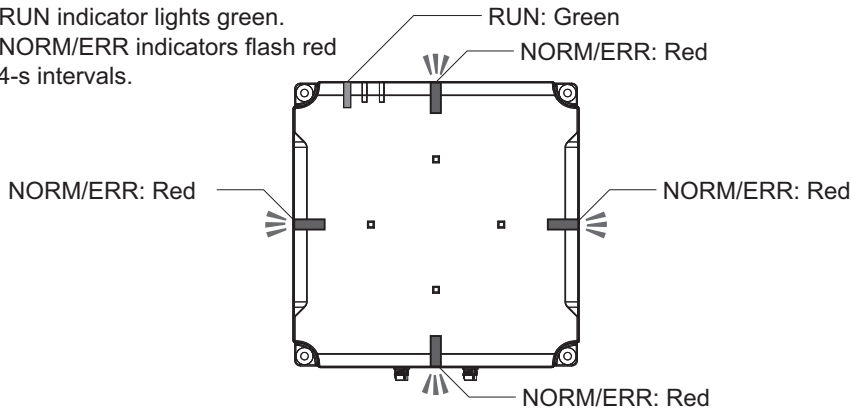

Illegal Network Setting or Incorrect Operating Mode Detection during Operation

The Reader/Writer starts in Safe Mode.

The RUN indicator flashes green at 0.4-s intervals.

The NORM/ERR indicators flash red at 0.4-s intervals.

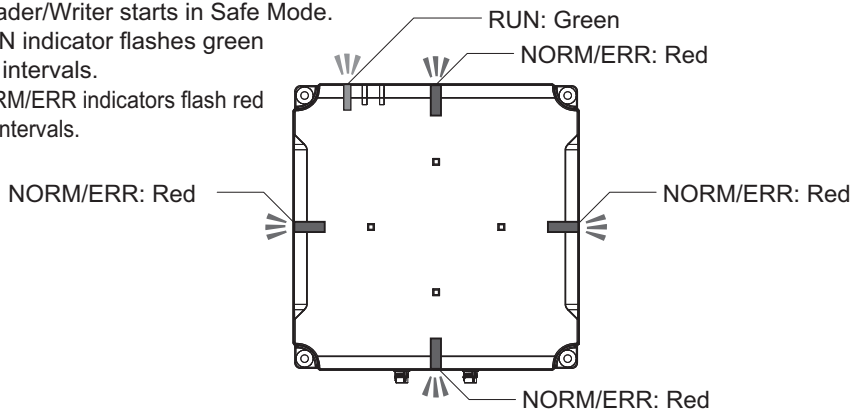

Major Faults

If a major fault is detected, the NORM/ERR indicators will light red. This is a fatal error, so you must replace the Reader/Writer.

If a major fault occurs during startup, the RUN indicator will flash and the Reader/Writer will start in Safe Mode.

The RUN indicator lights green.
The NORM/ERR indicators light red.

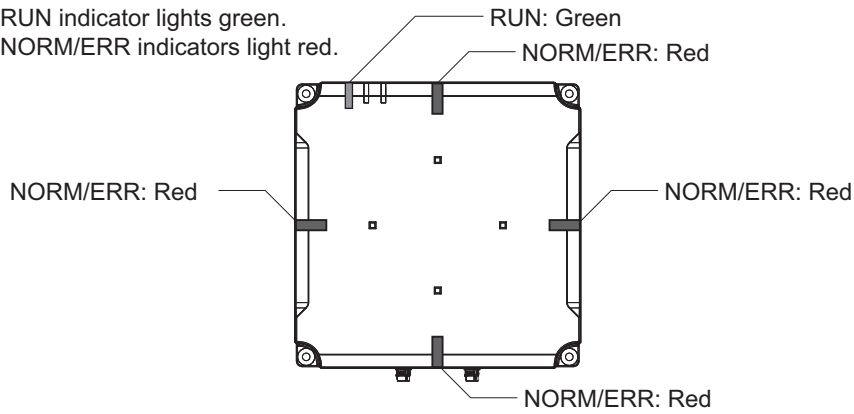

Major Fault Detection during Operation

The RUN indicator flashes green at 0.4-s intervals.
The NORM/ERR indicators flash red at 0.4-s intervals.

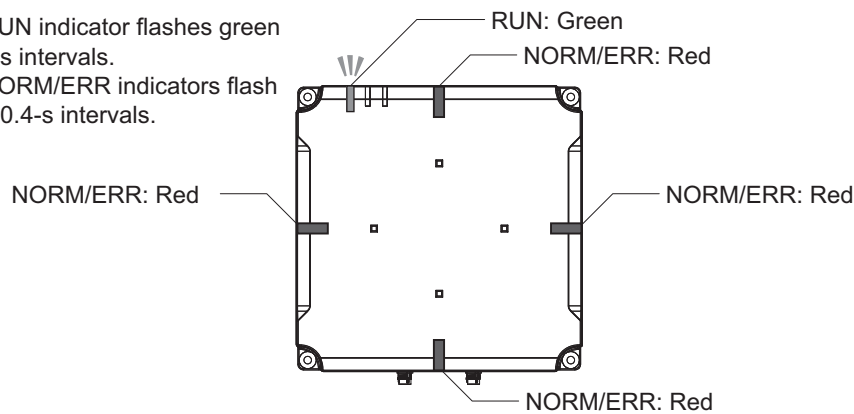

3-1-9 Operation Indicators when a Timeout is Detected in a Tag Data Link

The NORM/ERR indicators will flash yellow when a timeout is detected for the tag data link with the host device after the Reader/Writer starts normally.

The RUN indicator lights green.
The NORM/ERR indicators
flash yellow at 0.1-s intervals.

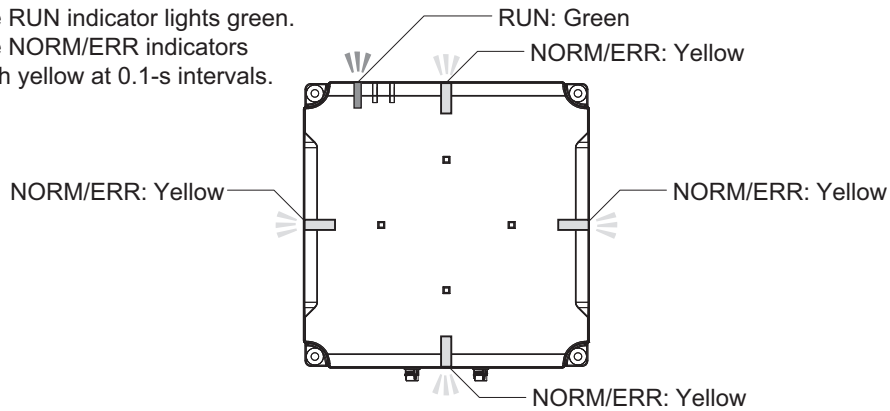

3-1-10 During Multi-Reader/Writer function use

SLAVE Mode

The RUN indicator will light yellow when a group-registered Reader/Writer is switched to from the master reader/writer and operates as a slave reader/writer.

The RUN indicator lights yellow.

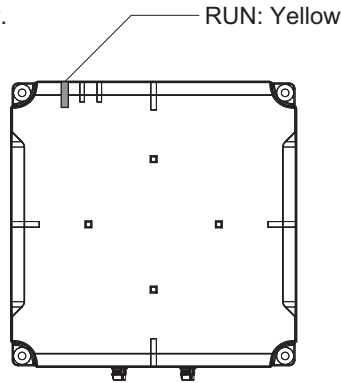

Normal completion of slave Reader/Writer command

The NORM/ERR indicators will light green once when processing ends normally for commands execution issued from the master Reader/Writer.

The RUN indicator lights yellow.
The NORM/ERR indicators flash green once.

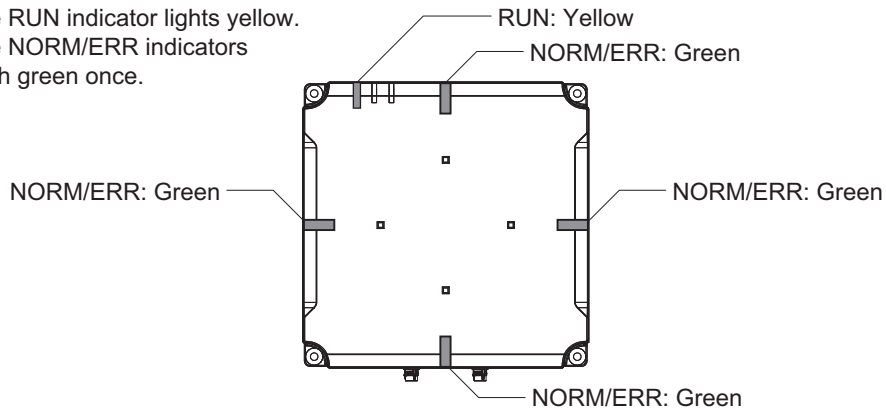

Abnormal completion of slave Reader/Writer command

The NORM/ERR indicators will light red once when processing ends abnormally for commands execution issued from the master Reader/Writer.

The RUN indicator lights yellow.
The NORM/ERR indicators flash red once.

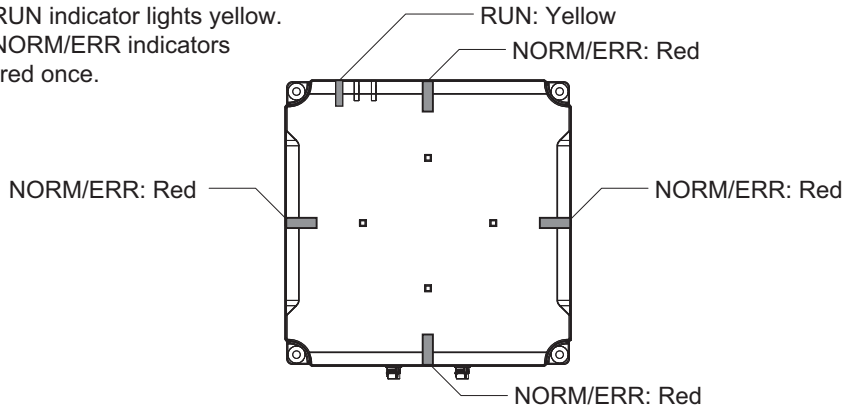

3-2 Connectors

This section describes the connectors on the Reader/Writer.

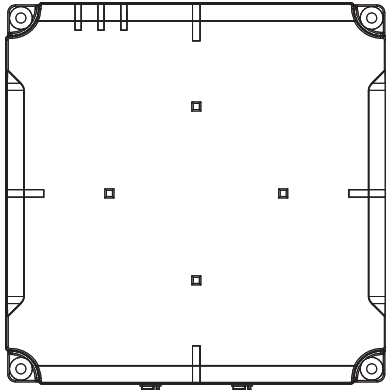

Ethernet connector — Power supply connector

● Power Supply Connector

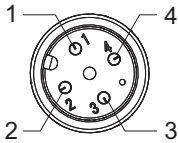

Size	Opening shape	Polarity	Pin No.	Name	Description	I/O
M12	Receptacle	Male	1	24P	+24 V	---
			2	CONT	Control signal (operating mode signal) *1. Run Mode: Connect to 24 V and then start the Reader/Writer. Safe Mode: Connect to 0 V and then start the Reader/Writer.	IN
			3	24N	0 V	---
			4	---	---	---

● Ethernet Connector

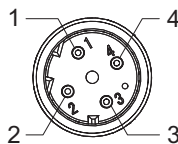

Size	Opening shape	Polarity	Pin No.	Name	Description	I/O
M12	Receptacle	Male	1	TD+	Ethernet send + signal	OUT
			2	RD+	Ethernet receive + signal	IN
			3	TD-	Ethernet send - signal	OUT
			4	RD-	Ethernet receive - signal	IN
			Housing	FG	Frame ground	---

4

Installation and Connections

This section describes the installation methods, wiring methods, and installation locations for the V780 Reader/Writer in detail.

4

4-1	Installation	4-2
4-1-1	Reader/Writer	4-2
4-1-2	RF Tags	4-4
4-2	Connections and Wiring	4-6
4-2-1	Connecting and Removing the Reader/Writer Power Cable and Ethernet Cable	4-6

4-1 Installation

This section describes the installation of the Reader/Writer and RF Tags.

4-1-1 Reader/Writer

V780-HMD68-EIP-□□/V780-HMD68-ETN-□□-S

The Reader/Writer can be installed from the front or the rear.

● Front Mounting

Install the Reader/Writer with four M6 bolts. Use both spring washers and flat washers.

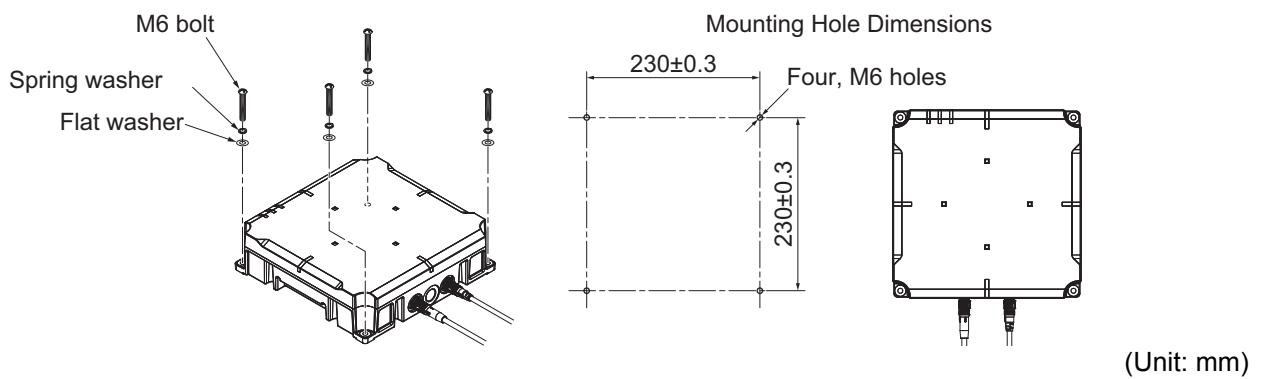

● Rear Mounting

Install the Reader/Writer with four M6 bolts. Use both spring washers and flat washers.

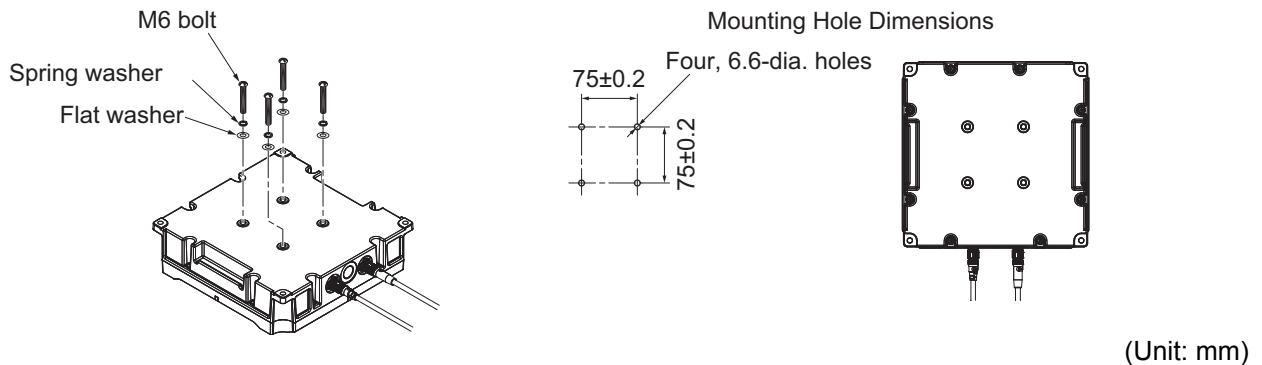

* If it is necessary to distinguish the appearance of the standard Reader / Writer (V780-HMD68-ETN- □□ / -EIP- □□) and the slave Reader / Writer (V780-HMD68-ETN- □□ -S), please take measures such as attaching a non-metallic label.

⚠ WARNING

- Injury may occur if the Reader/Writer falls and strikes a person. When you install the Reader/Writer, observe the tightening torque (4.3 N·m) for the M6 bolts.
- Observe all torque specifications for bolts.



Precautions for Correct Use

- An M6 bolt engagement length of 6 to 8 mm is necessary for rear mounting.
- The bolts may be hard to tighten. Tighten them to the recommended tightening torque.



Precautions for Safe Use

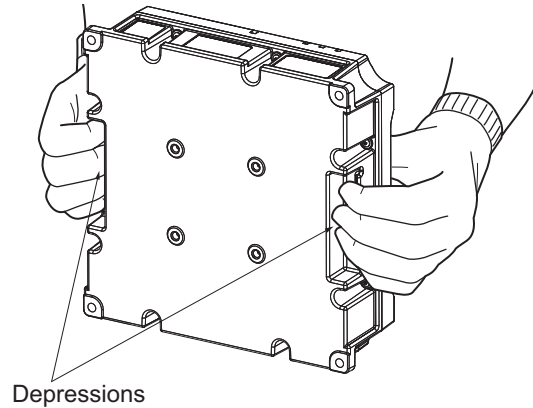
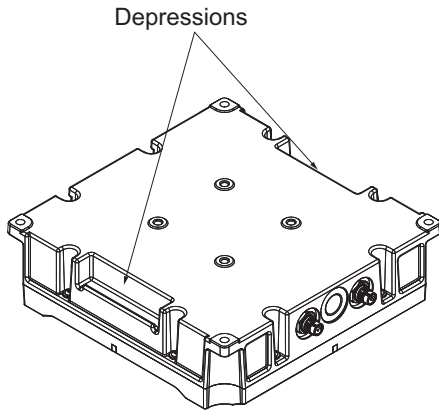

- The Reader/Writer weighs approx. 3 kg. It may be damaged if it falls. Use slip-resistant gloves when you install the Reader/Writer and hold the Reader/Writer securely at the depressions with both hands.
- Use slip-resistant gloves when you install the Reader/Writer. The Reader/Writer may be destroyed if it falls.



Additional Information

- For details on connection methods, refer to 4-2 *Connections and Wiring* on page 4-6.

● **Mounting Ferrite Cores**

(Model V780-HMD68-EIP-EU/-IN/-RU, and V780-HMD68-ETN-EU-S/-IN-S/-RU-S)

- 1** Wind the power cable and the Ethernet cable once to the ferrite core individually. Attach the ferrite core to the cable at the Reader/Writer side.

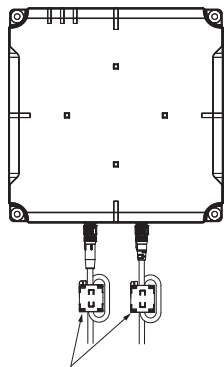

Ferrite cores

- 2** Close the ferrite core until it clicks into place.

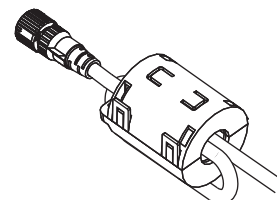
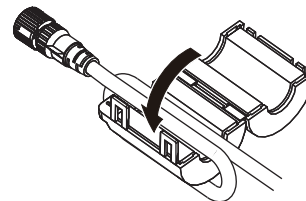

4-1-2 RF Tags

Mounting on Non-metallic Material (RF Tags Only)

- 1 Use two, M4 screws to mount the RF Tags from the marked side.
The tightening torque is 1.2 N·m.
The V780-A-TA-133-10^{*1} Attachment is not necessary.

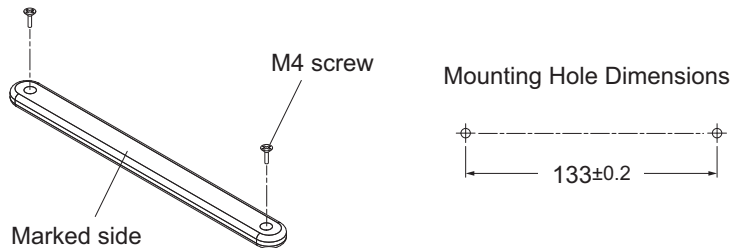

- *1. This is the model number for one package of 10 RF Tags.
Order the number of packages that you require.



Precautions for Correct Use

An M4 screw mating length of 4 mm or longer is necessary when mounting an RF Tag to a non-metallic material.

Mounting on Metallic Material (RF Tag and Attachment)

Mount the V780-A-JIME-Z3BLI-10^{*1} RF Tag in the V780-A-TA-133-10^{*1} Attachment, and then mount the Attachment to the metallic material.



Precautions for Correct Use

If you mount a V780-A-JIME-Z3BLI-10^{*1} RF Tag to a metallic material, use a V780-A-TA-133-10^{*1} Attachment. The communications distance will decrease drastically if there is metal at the back of the RF Tag.

- 1 Mount the RF Tag in the Attachment.
Use two M4 screws and tighten the nuts from the marked side of the RF Tag.
The tightening torque is 1.2 N·m.

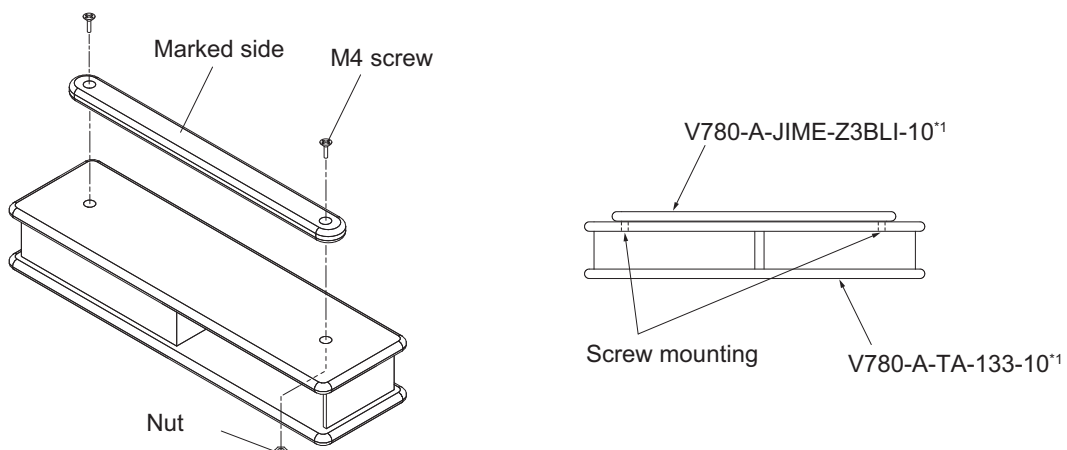

- 2** Mount the Attachment to which the RF Tag is mounted to the metallic material.
 Mount it with two M4 bolts.
 The tightening torque is 1.2 N·m.

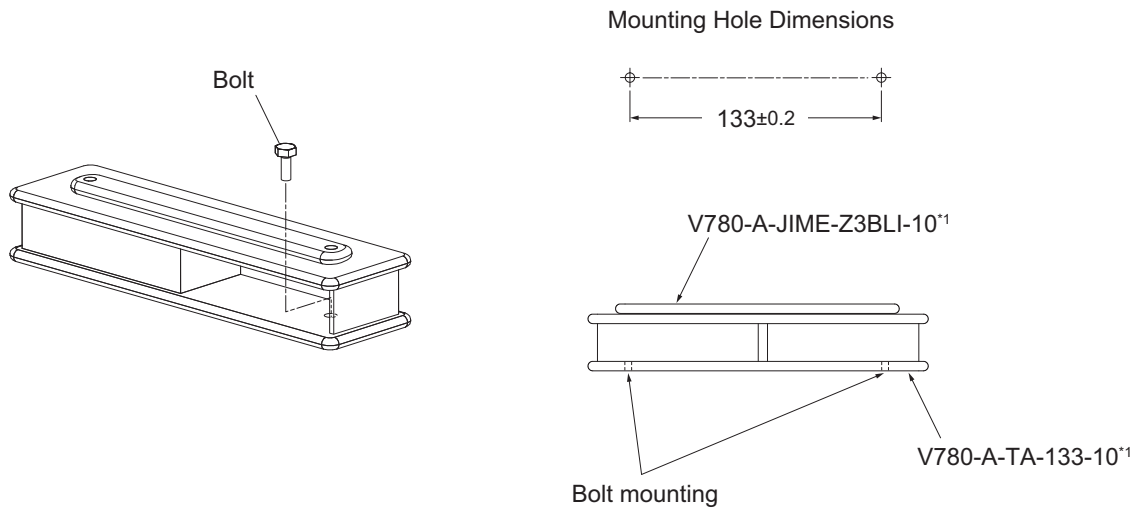

*1. This is the model number for one package of 10 RF Tags.
 Order the number of packages that you require.



Precautions for Correct Use

- An M4 screw mating length of 4 mm or longer is necessary when mounting an RF Tag and Attachment.
- An M4 bolt mating length of 4 mm or longer is necessary when mounting an RF Tag mounted in an Attachment to a metallic material.

4-2 Connections and Wiring

4-2-1 Connecting and Removing the Reader/Writer Power Cable and Ethernet Cable

Power Supply

Connect a power supply that meets the following conditions to the Reader/Writer.

Item	Condition
Supply voltage	24 VDC -15% to $+10\%$
Output current	500 mA min.
Safety standard	SELV (Safety Extra Low Voltage)

Connecting Method

- 1 Hold onto the connector on the Power Cable and insert it into the power connector on the Reader/Writer.

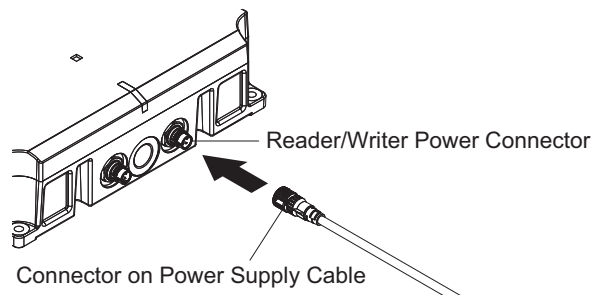

Precautions for Correct Use

Do not apply more than 30 N of force to the connector on the Reader/Writer.

- 2 Turn the connector on the Power Cable clockwise to lock it in place.
 - For the Recommended Cable
Turn the cable connector clockwise until you hear it securely lock in place.
 - For Other Cables
Observe the tightening torque specifications for the cable connectors.

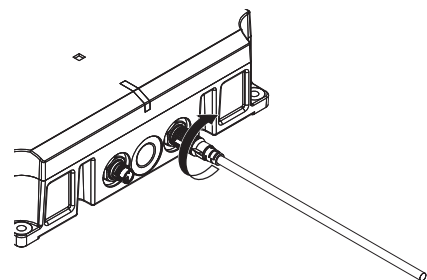

Pin No.	Name	Description	I/O
1	24P	+24 V	---
2	CONT	Control signal (operating mode signal) *1. Run Mode: Connect to +24 V and then start the Reader/Writer. Safe Mode: Connect to 0 V and then start the Reader/Writer.	IN
3	24N	0 V	---
4	---	---	---



Precautions for Correct Use

Pin 4 on the power supply connector is not used. Do not connect it to any terminal.



Additional Information

- To use the Reader/Writer in Run Mode, connect the control signal to +24 VDC of the power supply. If you connect the control signal to the 0-V side of the power supply, the Reader/Writer will start in Safe Mode.
- Refer to 6-1 *Operation Modes* on page 6-3 for information on Run Mode and Safe Mode.
- Connector Layout and Wire Diagram of Recommended Cable (XS5F-D42□-□80-F)

Connector Layout

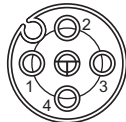

Wiring Diagram (Four Conductors)

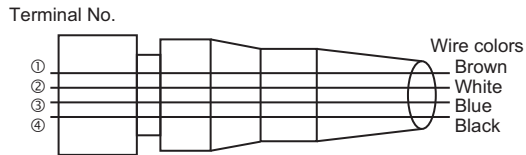

- 3** Hold onto the connector on the Ethernet Cable and insert it into the Ethernet connector on the Reader/Writer.

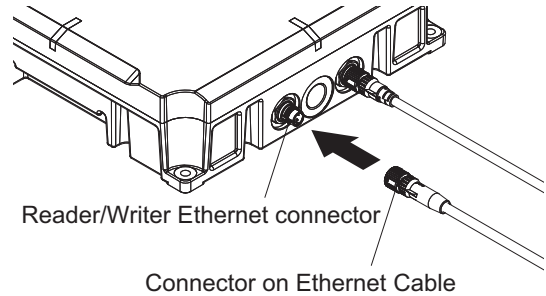

Precautions for Correct Use

Do not apply more than 30 N of force to the connector on the Reader/Writer.

- 4** Turn the connector on the Ethernet Cable clockwise to lock it in place.
- For the Recommended Cable
Turn the cable connector clockwise until you hear it securely lock in place.
 - For Other Cables
Observe the tightening torque specifications for the cable connectors.

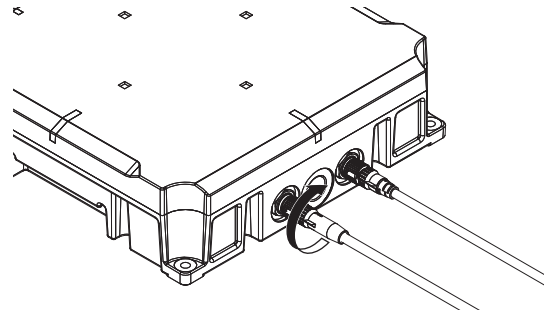

Pin No.	Name	Description	I/O
1	TD+	Ethernet send + signal	OUT
2	RD+	Ethernet receive + signal	IN
3	TD-	Ethernet send - signal	OUT
4	RD-	Ethernet receive - signal	IN
Housing	FG	Frame ground	---

Removal Method

- 1 Turn the connector on the Power Cable counterclockwise to unlock it.

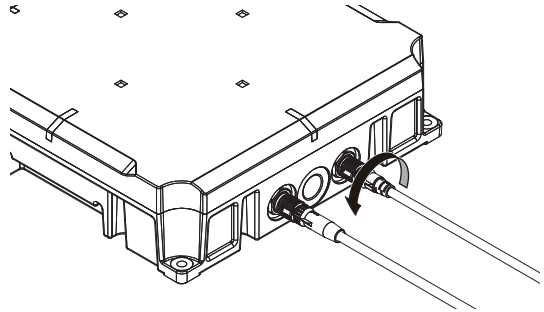

- 2 Hold onto the connector on the Power Cable and pull it straight out to remove it.

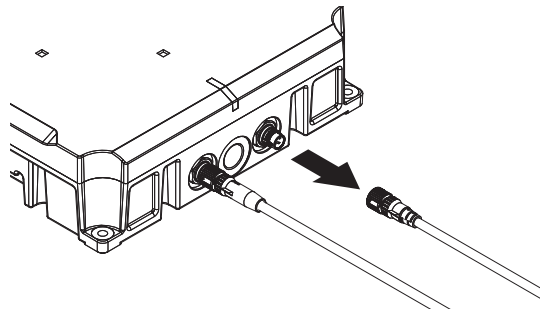

Precautions for Correct Use

If the connector is difficult to remove, press on the Reader/Writer and pull on the connector. Never pull on the Cable with excessive force. Doing so may break the wires and cause malfunction.

- 3 Turn the connector on the Ethernet Cable counterclockwise to unlock it.

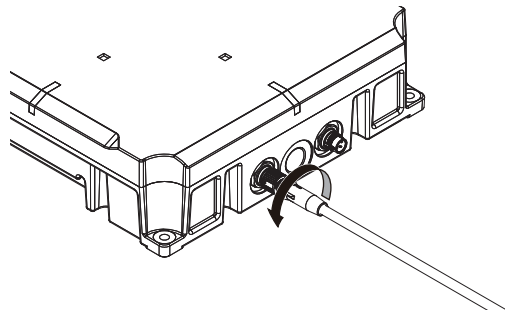

- 4 Hold onto the connector on the Ethernet Cable and pull it straight out to remove it.

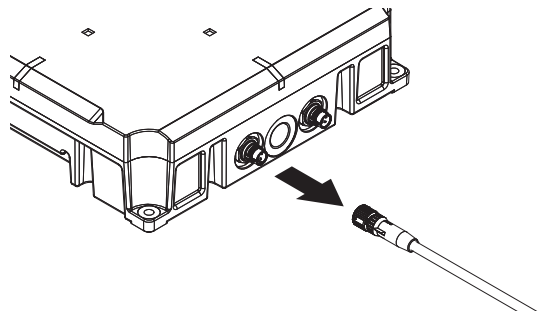

Precautions for Correct Use

If the connector is difficult to remove, press on the Reader/Writer and pull on the connector. Never pull on the Cable with excessive force. Doing so may break the wires and cause malfunction.

5

Preparations for Communications

This section describes how to set up communications with the V780 Reader/Writer.

5-1	Starting the Reader/Writer	5-2
5-1-1	Procedure to Start the Reader/Writer	5-2
5-2	Setting IP Addresses	5-3
5-2-1	Preparations for Work	5-3
5-2-2	Setting the IP Address of the Reader/Writer from a Web Browser	5-5
5-2-3	Setting the IP Address of the Reader/Writer on the Network Configurator ...	5-7

5-1 Starting the Reader/Writer

5-1-1 Procedure to Start the Reader/Writer

- 1** Connect the Cable to the Reader/Writer.



Additional Information

Refer to *4-2-1 Connecting and Removing the Reader/Writer Power Cable and Ethernet Cable* on page 4-6 for the methods to attach and connect the Reader/Writer Power Supply Cable and Ethernet Cable.

- 2** Connect the power supply lines and the operation mode signal line in the Cable to the power source and connect the RJ45 connector to an Ethernet port on the host device.
- 3** Turn ON the power supply to start the Reader Writer.
If the Reader Writer starts normally, the RUN indicator will light green.

5-2 Setting IP Addresses

5-2-1 Preparations for Work

1 Network Configuration

The network configuration that is described in this manual is shown in the following figure. Connect the Reader/Writer and the computer with an Ethernet Cable.

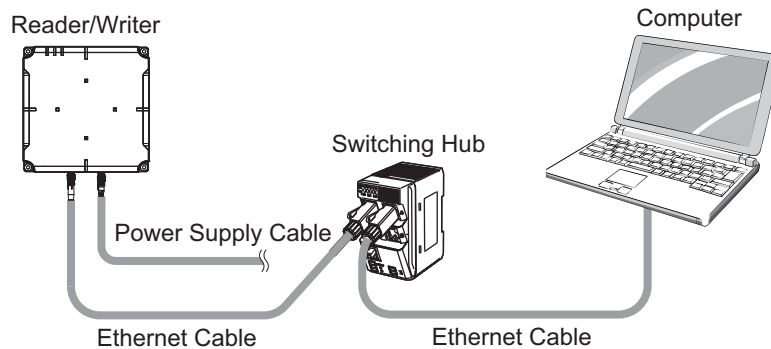

2 Set the IP address on the computer.

Set the IP addresses on the computer.

The default IP addresses of the Reader/Writer are given in the following table. Use these addresses to set the IP address on the computer.

This example changes the last part of the IP address to a value other than 200 (i.e., to 1 to 199 or 201 to 254). Values of 0 and 255 cannot be used.

- Default IP Address Settings of the Reader/Writer

Setting item	Default setting
IP address	192.168.1.200 (fixed setting)
Subnet mask	255.255.255.0 (fixed setting)
Default gateway	192.168.1.254 (fixed setting)



Additional Information

Sysmac Studio cannot set the IP address for the Reader/Writer with its default function.

You must specify the [SET TCP/IP COMMUNICATIONS CONDITIONS] command in a ladder logic program/ST program to set it. Alternatively, use **Browser Interface** or **Network Configurator**.

Setting the IP Address on the Computer with Windows 7 or Windows 10

- 1 Open the Control Panel, and select **Network and Internet** and then **Network and Sharing Center**.
- 2 Select **Change adapter settings** and then right-click **Local Area Connection**.
- 3 Right-click **Local Area Connection** and select **Properties**.
- 4 Select **Internet Protocol Version 4 (TCP/IPv4)** and then click the **Properties** Button.

- 5** Select the *Use the following IP address* Option, make the following settings, and then click the **OK** Button.
Change the last part of the IP address to a value other than 200 (i.e., to 1 to 199 or 201 to 254).
Values of 0 and 255 cannot be used.
- 6** Click the **OK** Button to close the Internet Protocol Version 4 (TCP/IPv4) Properties Dialog Box.

5-2-2 Setting the IP Address of the Reader/Writer from a Web Browser

1 Start the Web browser.

Enter the IP address of the Reader/Writer in the address field of the Web browser to display the Browser Operation Window. Enter `http://192.168.1.200` if you are using the default IP address.

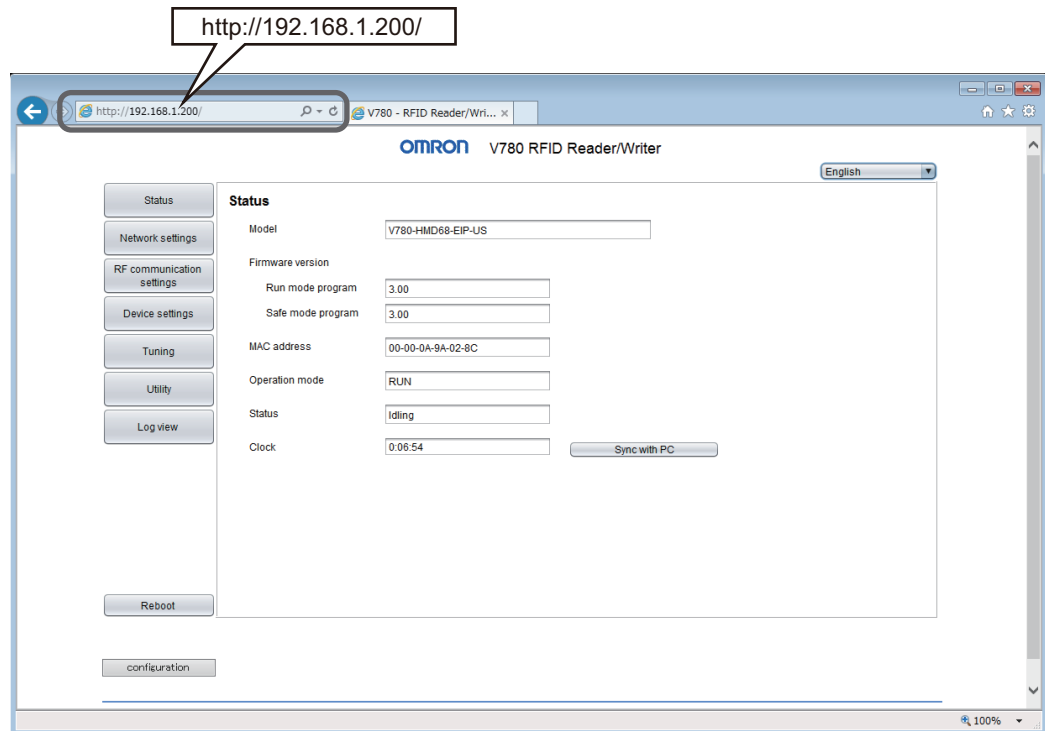

2 Set the IP address of the Reader/Writer.

Click the **Network settings** Button at the upper left of the Web Browser Operation Window.

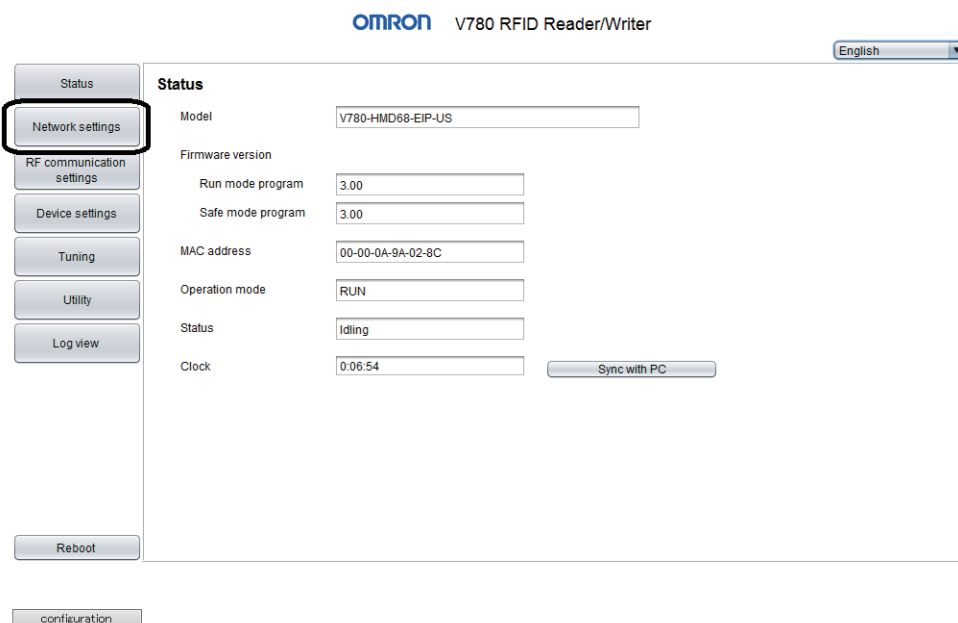

The Network settings View will be displayed.

● Setting a Fixed IP Address

On the Network Settings View, select the *Fixed setting* Option, enter the *IP address*, *subnet mask*, and *gateway address*, and then click the **Set** Button.

The screenshot shows the 'Network settings' page for the OMRON V780 RFID Reader/Writer. The 'Fixed setting' radio button is selected and circled in red. The IP address is set to 192.168.1.200, the subnet mask to 255.255.255.0, and the gateway address to 192.168.1.254. The 'Set' button is also circled in red. A 'configuration' button is visible at the bottom left.

● Getting an IP Address from a BOOTP Server

On the Network Settings View, select the *Obtain from BOOTP server* Option or the *Fix at the IP address which is obtained from BOOTP server* Option, and then click the **Set** Button.

The screenshot shows the 'Network settings' page for the OMRON V780 RFID Reader/Writer. The 'Obtain from BOOTP server' radio button is selected and circled in red. The IP address, subnet mask, and gateway address fields are present but disabled. The 'Set' button is also circled in red. A 'configuration' button is visible at the bottom left.

3 Paste the IP address memo label.

Write the set IP address on the IP address memo label and paste it on the target reader/writer.



Precautions for Correct Use

If you use the BOOTP client function, the IP addresses specified for the following Reader/Writer function will change dynamically and may result in an unexpected operation. Make sure there are no problems before using the BOOTP client.

- IP addresses of the Slave Reader/Writers for multi-Reader/Writer function

5-2-3 Setting the IP Address of the Reader/Writer on the Network Configurator

1 Start the Network Configurator.

To start the Network Configurator, select **All Programs - OMRON - Sysmac Studio - Network Configurator for EtherNet/IP - NetworkConfigurator** from the Windows Start Menu. The following window will be displayed when the Network Configurator starts.

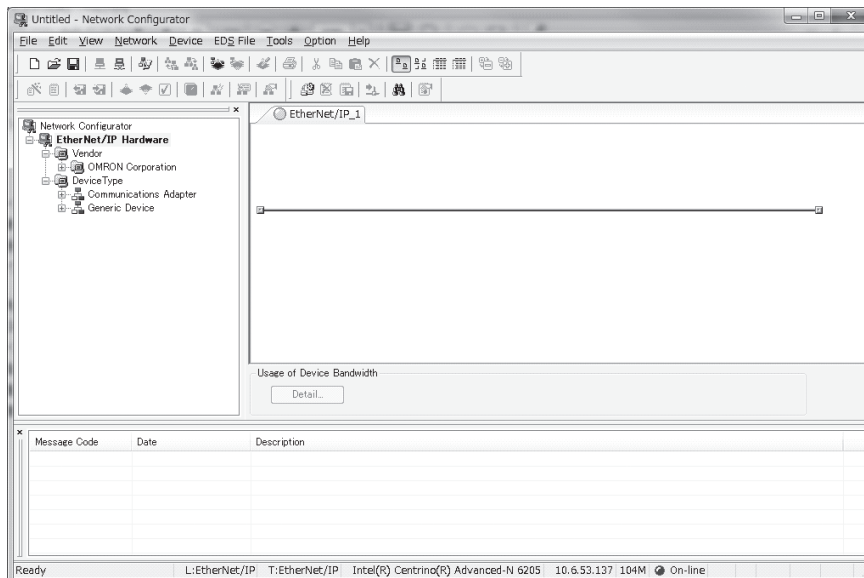

2 Go online with the network.

Here, the Network Configurator is placed online through Ethernet. Select **Network - Connect**.

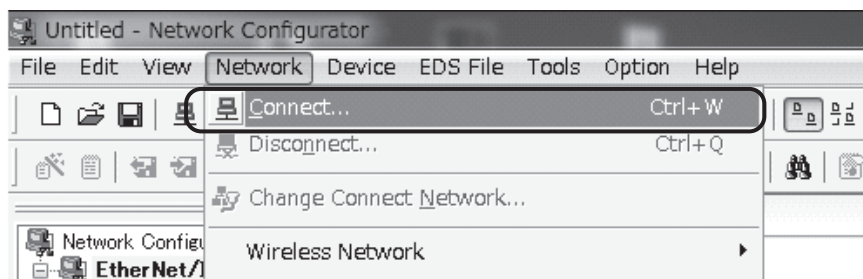

3 Set the IP address of the Reader/Writer.

Select **Tools - Setup TCP/IP Configuration** to open the Setup TCP/IP Configuration Dialog Box.

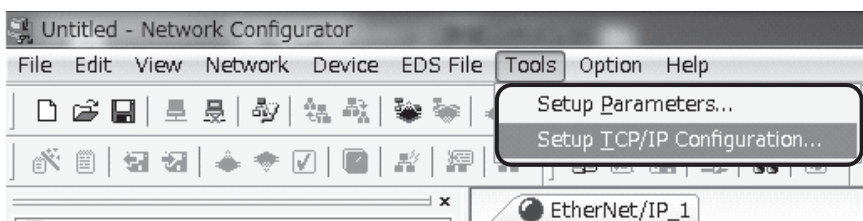

Enter the default IP address of the Reader/Writer (192.168.1.200) in the *Target IP Address Box*.

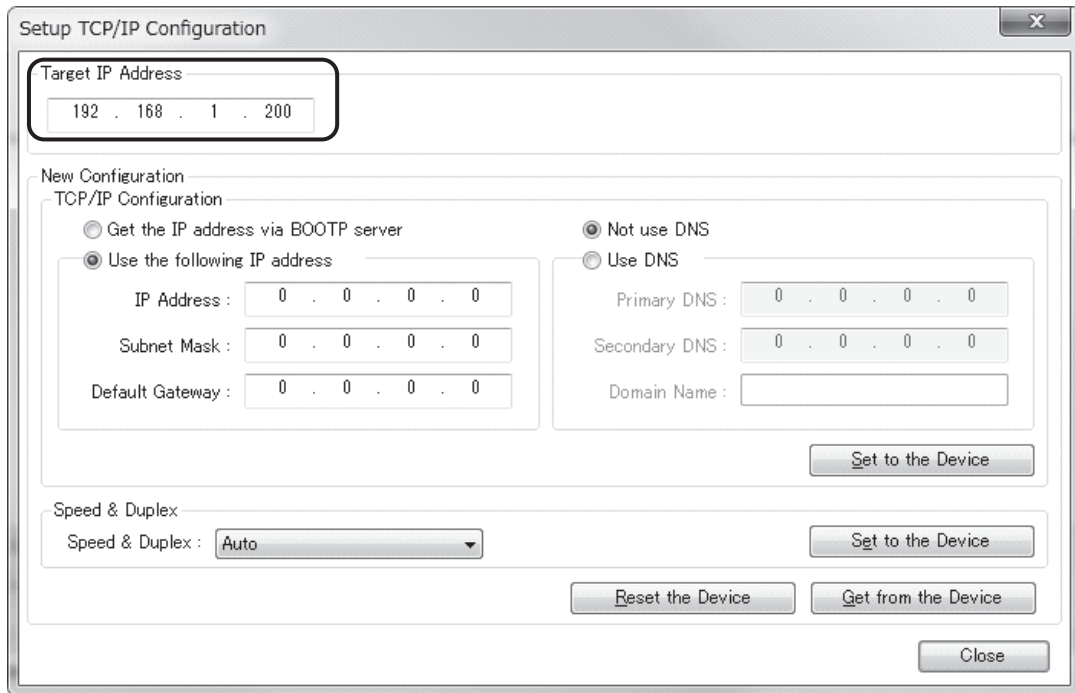

● **Setting a Fixed IP Address**

1. Enter the IP address, subnet mask, and default gateway.
2. Click the **Set to the Device** Button.
3. Click the **Reset the Device** Button to apply the IP address setting in the Reader/Writer.

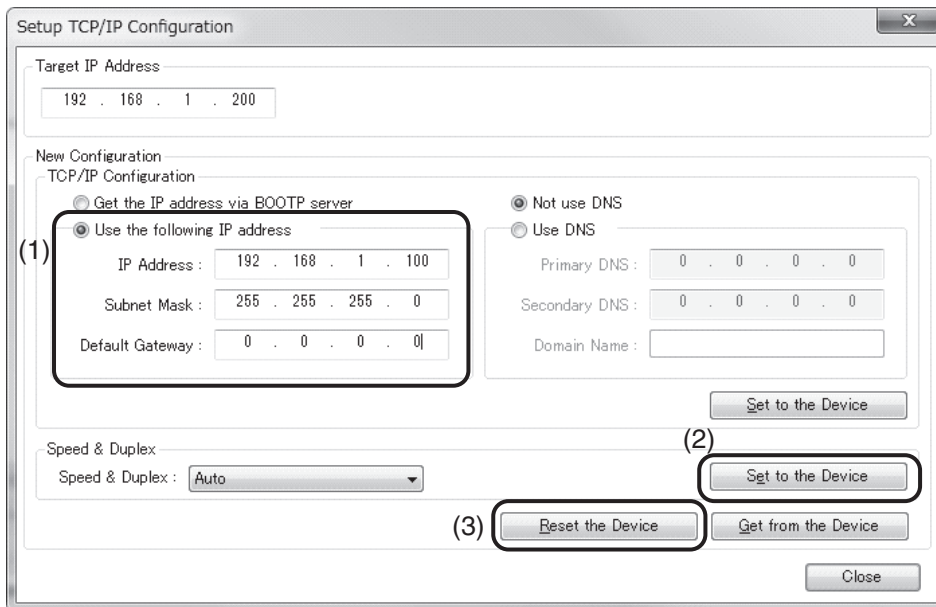

● Getting an IP Address from a BOOTP Server

1. Select the Get the IP Address via BOOTP server option.
2. Click the **Set to the Device** Button.
3. Click the **Reset the Device** Button to apply the IP address setting in the Reader/Writer.

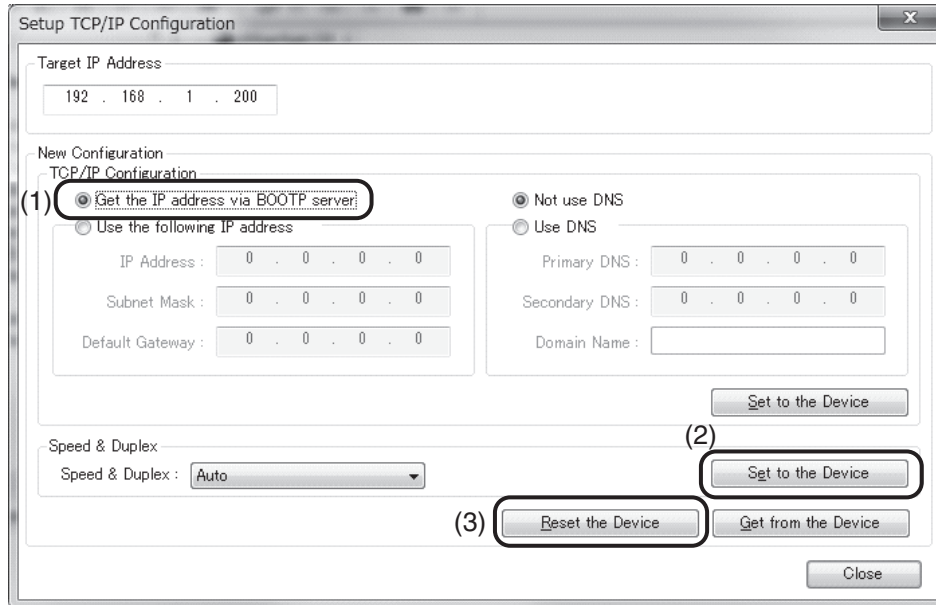

5-3 Setting Tag Data Links

Refer to *7-1-3 Tag Data Link Setting Methods* on page 7-4.

6

Functions

This section describes the functions that you can use with a V780 Reader/Writer.

6-1	Operation Modes	6-3
6-1-1	Run Mode	6-3
6-1-2	Safe Mode	6-3
6-2	RF Tag Communications	6-4
6-2-1	Single-access Communications	6-4
6-2-2	Multiaccess Communications	6-5
6-2-3	RF Communications Modes	6-6
6-2-4	Communications Commands	6-15
6-3	Reader/Writer Controls	6-20
6-3-1	Initialization	6-20
6-3-2	Resetting	6-20
6-3-3	RESET FOCUS	6-21
6-3-4	Installation Location Notification	6-22
6-4	Reader/Writer Settings	6-23
6-4-1	Network Settings	6-23
6-4-2	RF Communications Conditions: Basic Settings	6-24
6-4-3	RF Communications Conditions: Advanced Settings	6-26
6-4-4	Device Settings	6-33
6-4-5	Exporting/Important Configuration Files	6-35
6-5	Maintenance: Device Information	6-36
6-5-1	Reading Device Information	6-36
6-5-2	Getting the Operating Status	6-36
6-5-3	Getting and Setting Time Information	6-36
6-6	Maintenance: Log Information	6-37
6-6-1	Getting and Clearing the System Error Log	6-37
6-6-2	Getting the Command Error Log	6-38
6-6-3	Getting the Most Recent Command Error Information	6-38
6-7	Maintenance: Communications Information	6-39
6-7-1	Getting the Reception Level	6-39
6-7-2	Getting the Noise Level	6-39
6-7-3	Communications Diagnostics	6-40

6-8 Tuning	6-45
6-8-1 Transmission Power Tuning	6-45
6-9 Utilities	6-48
6-9-1 RF Tag Access	6-48
6-9-2 RF Tag Scanning	6-49
6-9-3 Reception Level Monitor	6-50
6-9-4 Channel Monitor	6-56
6-9-5 Focus Monitor	6-57
6-10 Multi-Reader/Writer Function	6-60
6-10-1 Outline	6-60
6-10-2 Multi-Reader/Writer Modes	6-61
6-10-3 Application	6-68
6-10-4 Communications conditions during Multi-Reader/Writer use	6-77
6-10-5 Maintenance functions during Multi-Reader/Writer use	6-78

6-1 Operation Modes

The Reader/Writer has two operation modes: Run Mode and Safe Mode. You can use the control signal on pin 2 of the power supply connector to the Reader/Writer to change between these modes.

6-1-1 Run Mode

If you connect the control signal (pin 2, white wire) on the power supply connector on the Reader/Writer to the 24-VDC (positive) side of the power supply and turn ON the power supply, the Reader/Writer will start in Run Mode. Operation is performed as specified in the commands from the host device and the results are returned to the host device as responses.

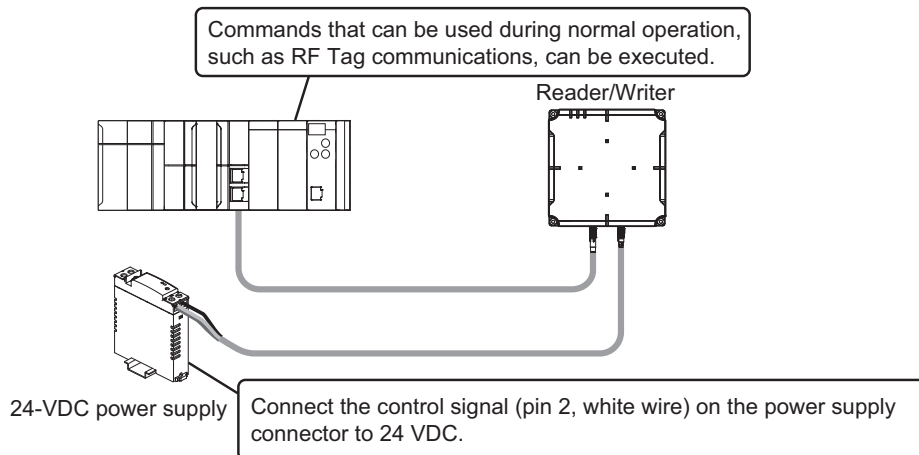

Precautions for Correct Use

Communication is performed only via the master reader/writer when the slave reader/writer (V780-HMD68-ETN-□□-S) starts in RUN mode.

It can not be controlled from a host device such as PLC. But web server function is available.

6-1-2 Safe Mode

If you connect the control signal (pin 2, white wire) on the power supply connector on the Reader/Writer to the 0-VDC (negative) side of the power supply and turn ON the power supply, the Reader/Writer will start in Safe Mode. The Safe Mode is used when you do not remember the IP address that is set in the Reader/Writer. In Safe Mode, the Reader/Writer will start with the following IP settings.

IP address: 192.168.1.200

Subnet mask: 255.255.255.0

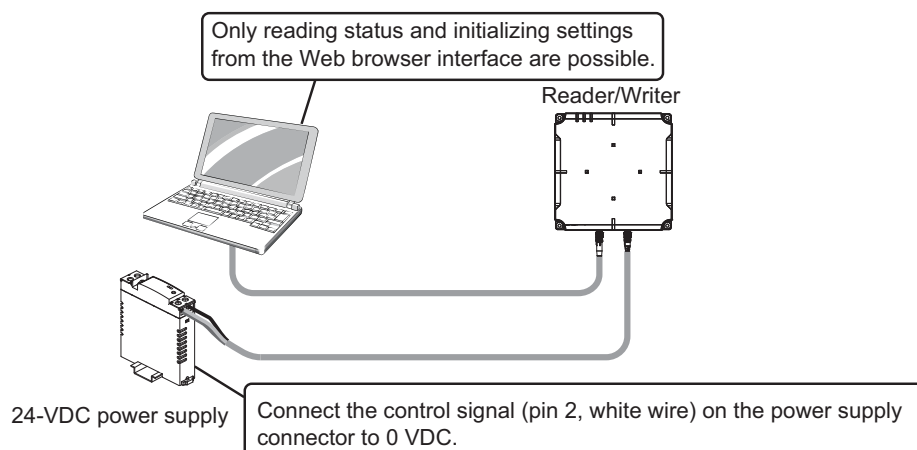

6-2 RF Tag Communications

This section describes communications between the Reader/Writer and RF Tags. The operation sequence for communications with RF Tags, response timing, and other factors depend on the communications command and communications mode.

6-2-1 Single-access Communications

With single-access communications, the Reader/Writer communicates with only one RF Tag in the communications range.

Commands for single-access communications return the results of communications with the first RF Tag detected in the communications range as the response.



Precautions for Correct Use

If there is more than one RF Tag in the communications range, communications may not be performed correctly.

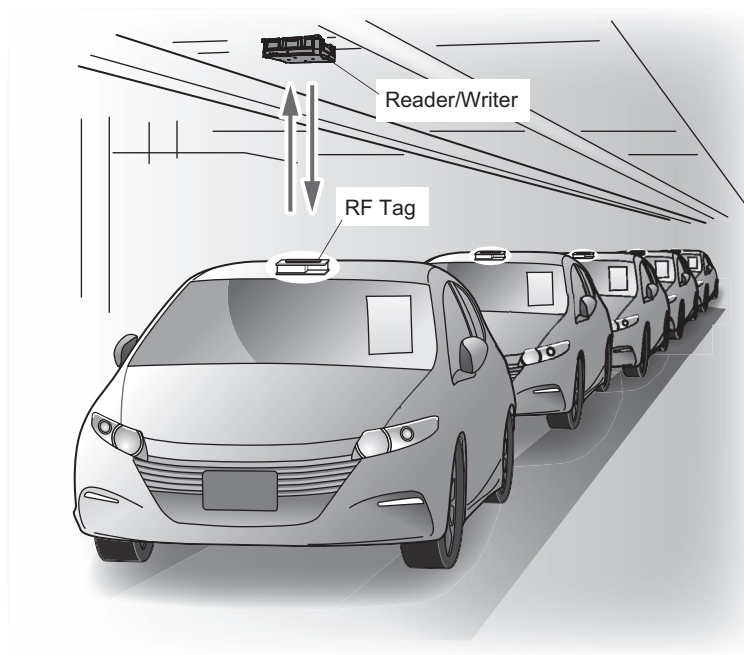

6-2-2 Multiaccess Communications

With multiaccess communications, the Reader/Writer communicates with more than one RF Tag in the communications range.

For multiaccess communications, the results of communications with all RF Tags in the communications range within the timeout time are returned as the response. Communications can be performed with up to 64 RF Tags with one communications command.

If writing were performed with multiaccess communications, it would not be possible to know which RF Tag was written to, so multiaccess writing is not supported.

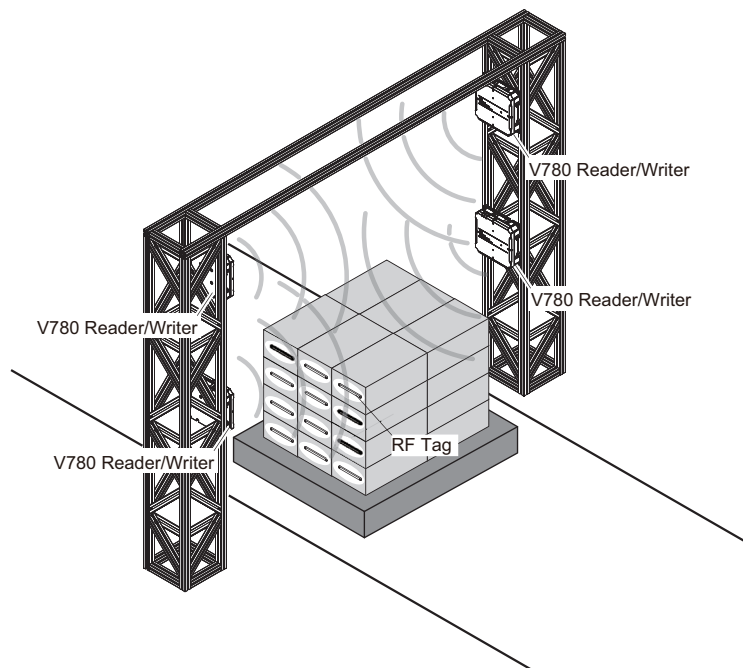
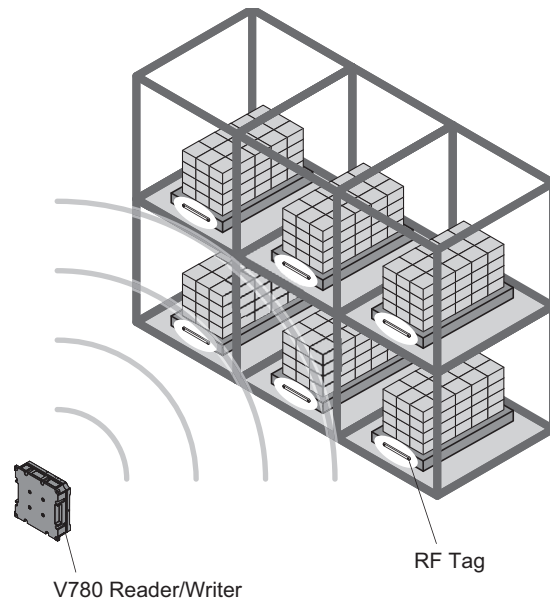

6-2-3 RF Communications Modes

The processing of communications with RF Tags depends on the RF communications mode that is specified in the Reader/Writer.

The setting of the communications mode is effective immediately after it is changed. It is saved in internal memory in the Reader/Writer even after the power supply is turned OFF.

Name	Single-access	Multiaccess	Description
Once	Supported	Supported	The Reader/Writer communicates with RF Tags when a command from the host device is executed.
Auto	Supported	Supported	When the Reader/Writer receives a command from the host device, the Reader/Writer waits, automatically detects an RF Tag entering the communications range, and communicates with it.
Focus	Supported	Not supported	The Reader/Writer constantly monitors RF Tags that enter the communications range. When it receives a command from the host device, it automatically determines which RF Tag in the communications range is in front of the Reader/Writer and communicates with that RF Tag.
Repeat	Supported	Supported	After the Reader/Writer receives a command, it repeatedly communicates with the RF Tags and returns a response when communicating with an RF Tag was possible. Until the smoothing buffer becomes full, the Reader/Writer does not communicate with the RF Tag once communicated.

Once

The Reader/Writer communicates with an RF Tag when it receives a command from the host device.

When the Reader/Writer is finished communicating with the RF Tag, it returns the communications results to the host device and waits for another command.

If there is no RF Tag in the communications range when the Reader/Writer executes the command, an RF Tag missing error will occur. It is therefore necessary to use a sensor or other device to detect the presence of an RF Tag before a command is executed.

● Single-access Operation

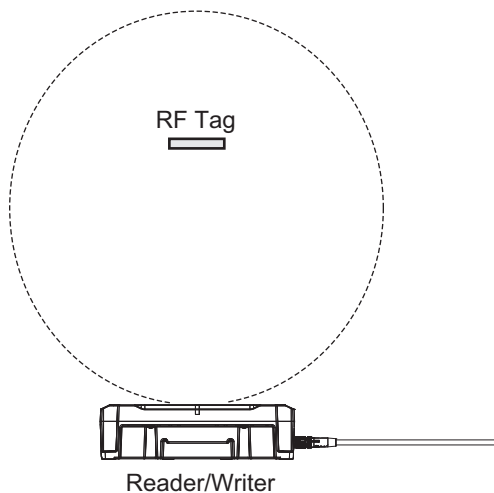

- If RF Tag exist in the communications range and communications with the RF Tag succeeds
After detection of the RF Tag, when the communication with the RF Tag is completed, the Reader/Writer returns the communication result without waiting for the timeout.

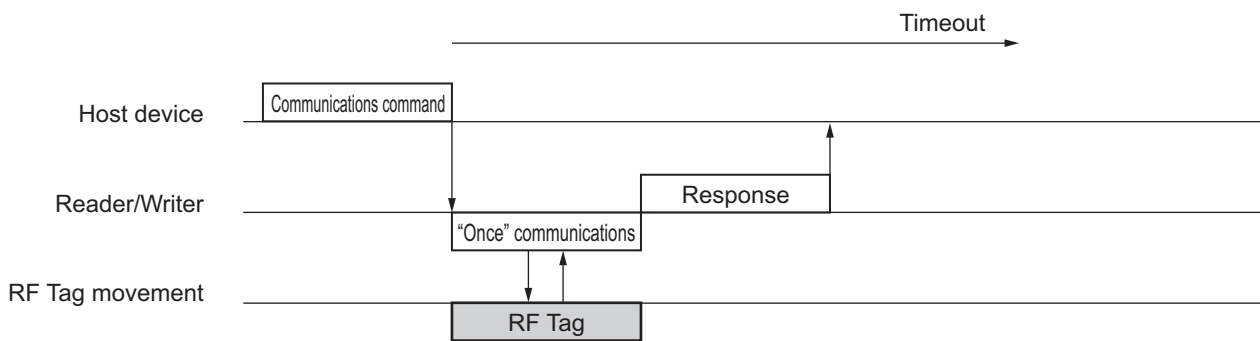

- If RF Tag exist in the communications range and communications with the RF Tag fails
After detection of the RF Tag, when the communication with the RF Tag is failed, the Reader/Writer repeats communication until the timeout even. If the Reader/Writer cannot complete communications within the timeout time, the communications results (“RF Tag communications failed”) will be returned.

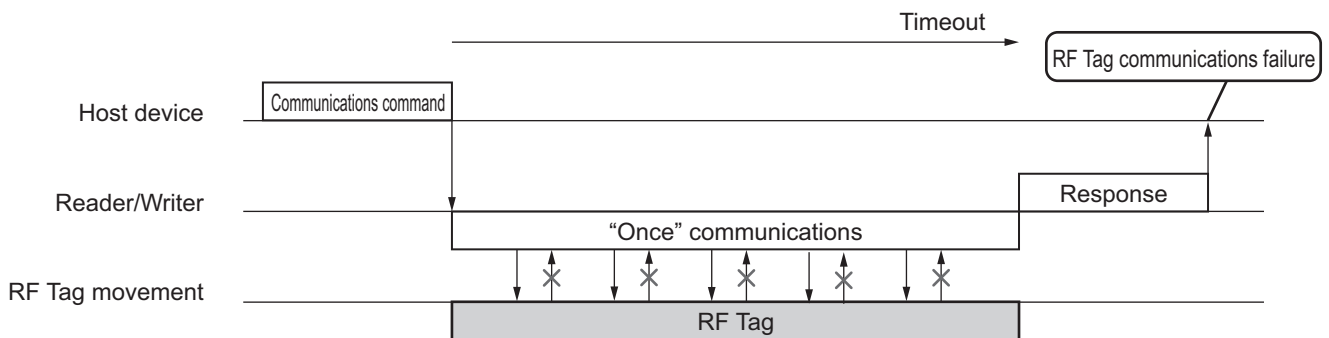

Additional Information

The behavior of the RF Tag that has communicated once with the Reader/Writer depends on the **Gen2 session** setting in the advanced RF communications settings. For details, refer to *Gen2 Session* on page 6-28.

- No RF Tag in the Communications Range
When the Reader/Writer cannot detect the RF Tag, repeats detect an RF Tag until the timeout even. If the Reader/Writer cannot detect the RF Tag within the timeout time, the communications results (“RF Tag missing error”) will be returned.

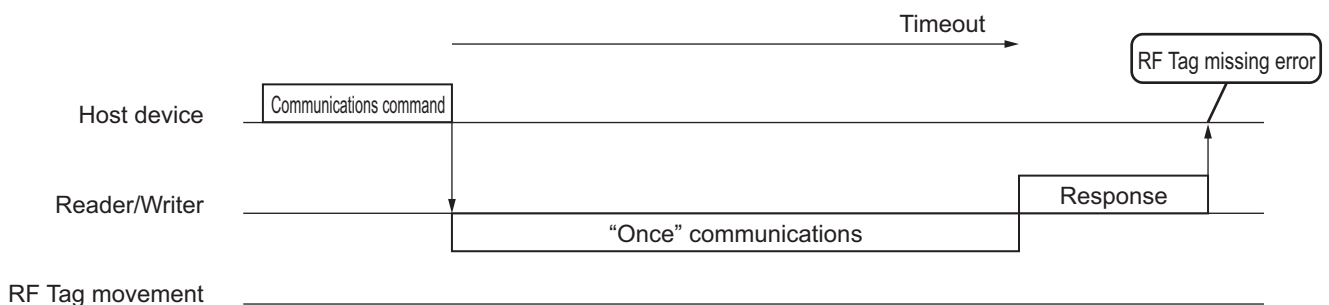

● Multiaccess Operation

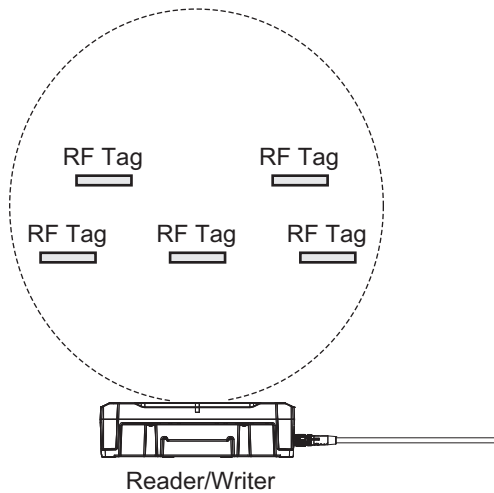

- One or More RF Tags in the Communications Range

If the Reader/Writer detects more than one RF Tag within the timeout time, it waits for the timeout and then returns the communications results. Communications results are not returned for RF Tags that could not be communicated with within the timeout time.

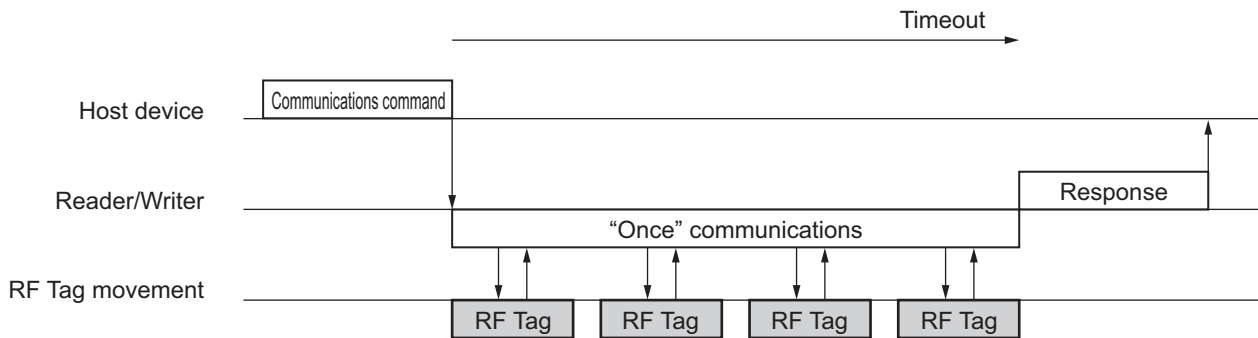

Additional Information

The behavior of the RF Tag that has communicated once with the Reader/Writer depends on the **Gen2 session** setting in the advanced RF communications settings. For details, refer to *Gen2 Session* on page 6-28.

- No RF Tag in the Communications Range

When the Reader/Writer does not detect an RF Tag in the communications range, it waits for a timeout and then returns the communications results (RF Tag missing error).

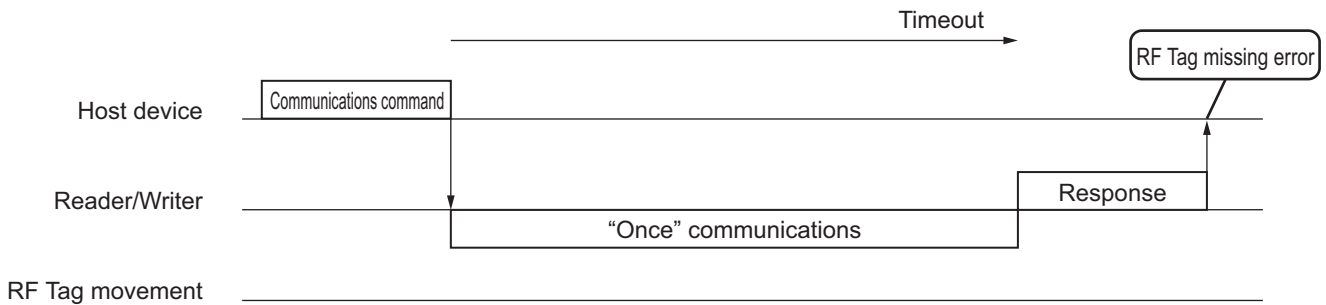

Auto

When the Reader/Writer receives a command from the host device, it automatically detects RF Tags in the communications range and communicates with them.

When the Reader/Writer is finished communicating with the RF Tag, it sends the response to the host device and waits for another command. With auto communications, the Reader/Writer automatically detects RF Tags, so a sensor or other device to detect RF Tags is not necessary. Also, auto communications will continue indefinitely until a command to stop communications is received from the host device.

● Single-access Operation

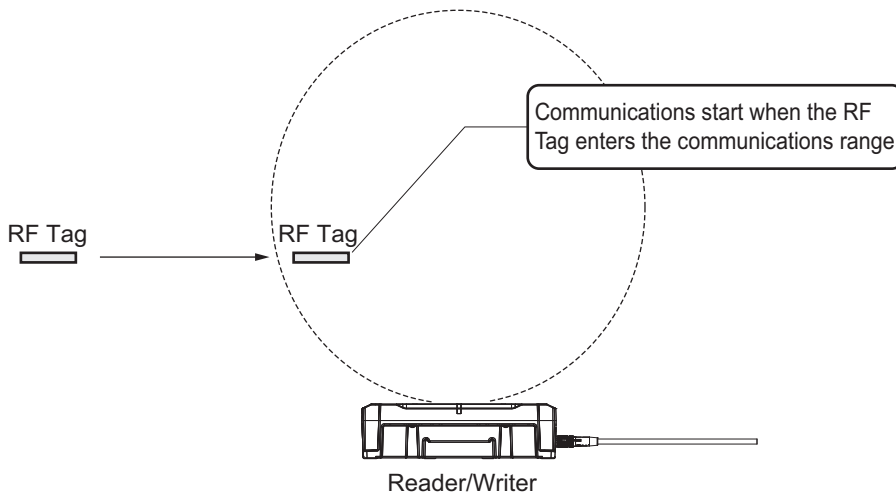

The Reader/Writer waits for an RF Tag to enter the communications range and returns the communications results after it detects an RF Tag. If there is already an RF Tag in the communications range when the command is executed, the Reader/Writer communicates with the RF Tag.

The timeout setting is disabled for single-access communications.

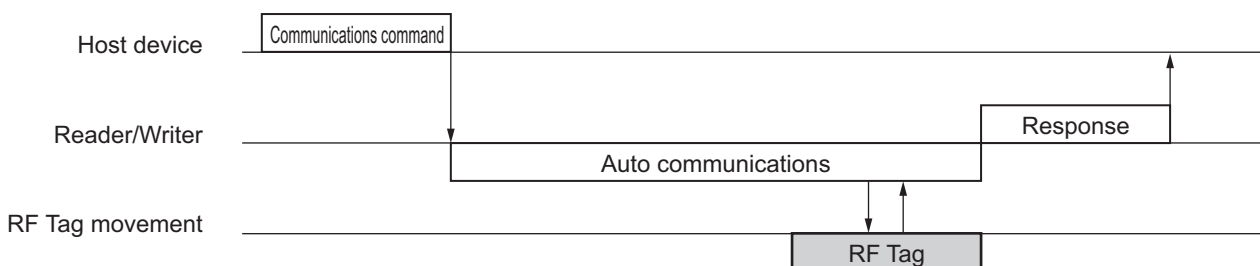



Additional Information

The behavior of the RF Tag that has communicated once with the Reader/Writer depends on the **Gen2 session** setting in the advanced RF communications settings. For details, refer to *Gen2 Session* on page 6-28.

● Multiaccess Operation

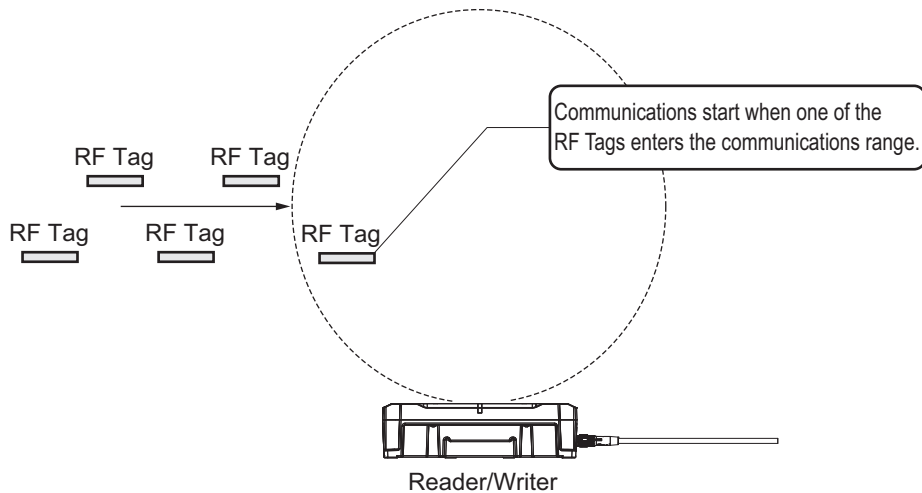

After the command from the host device is executed, the Reader/Writer automatically detects any RF Tags that enter the communications range and starts communications when even one RF Tag is detected. If the Reader/Writer then detects more RF Tags within the timeout time, it waits for the timeout and then returns the communications results. Communications results are not returned for RF Tags that could not be communicated with within the timeout time.

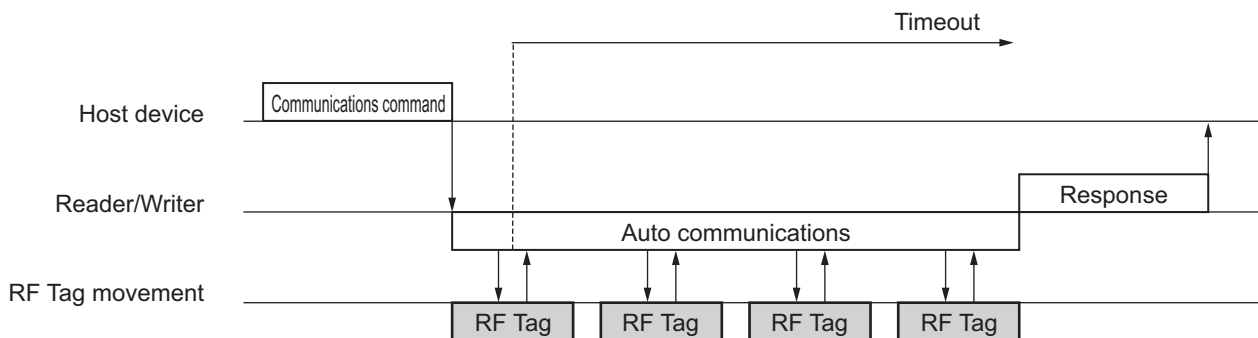

Additional Information

The behavior of the RF Tag that has communicated once with the Reader/Writer depends on the **Gen2 session** setting in the advanced RF communications settings. For details, refer to *Gen2 Session* on page 6-28.

Focus

Use Focus Mode to differentially communicate with the RF Tag that is just in front of the Reader/Writer.

When the Reader/Writer is in operation in Focus Mode, it constantly monitors RF Tags in the communications range. When the Reader/Writer receives a command from the host device, it automatically selects, from all of the monitored RF Tags, the RF Tag that is in front of the Reader/Writer (the target RF Tag) and communicates with it. Even if there are RF Tags that are not to be read in the communications range (non-target RF Tags), the Reader/Writer communicates only with the target RF Tag in front of the Reader/Writer.

You can use Focus Mode to help prevent reading non-target RF Tags or to help prevent missing the target RF Tag due to reading non-target RF Tags.

It is necessary to use a sensor or other device to confirm that the target RF Tag is in front of the Reader/Writer before the command is executed.



Precautions for Correct Use

When the Reader/Writer is in operation in Focus Mode, it calculates the target levels for the RF Tags in the communications range. When the command from the host device is executed, the Reader/Writer selects the target RF Tag with the highest target level. The selected RF Tag is identified as already being processed and the Reader/Writer will not communicate with it again until it leaves the communications range. If the RF Tag enters the communications range again, communications are again enabled with it as a selection candidate. (The “processed” status is cleared when the target level drops to 0 or lower.)

If there is only one RF Tag in the communications range when the command is executed, that RF Tag will be selected as the target RF Tag. However, any RF Tag that was previously communicated with and is identified as having already been processed will not be selected as the target RF Tag.

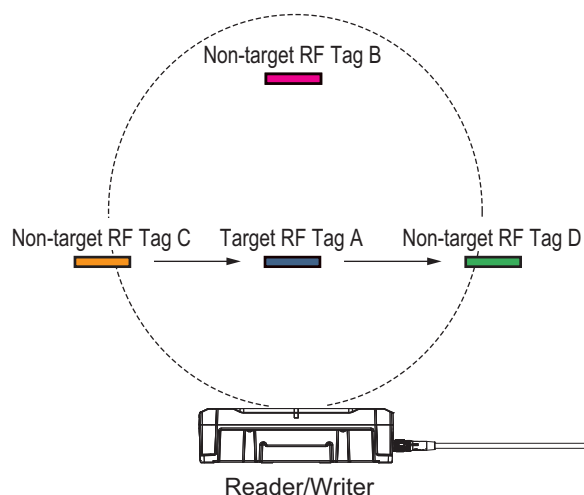

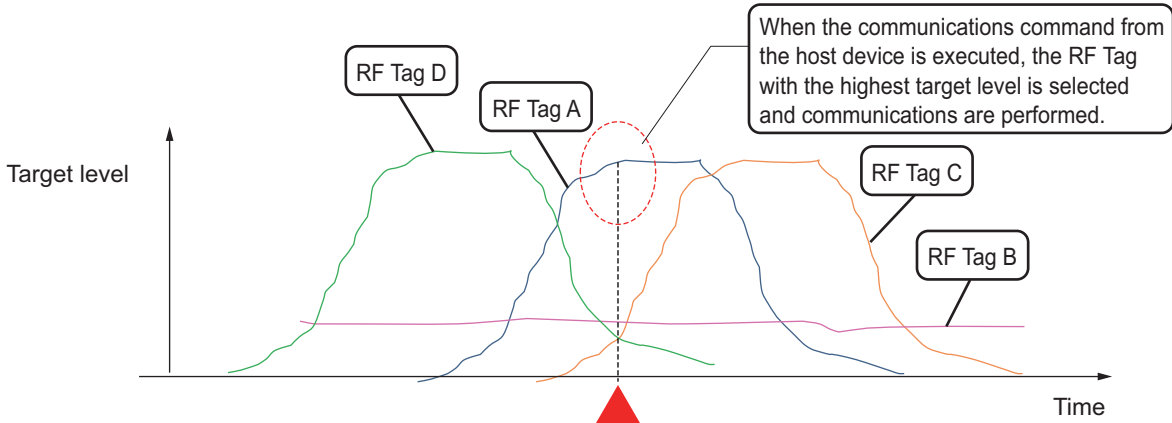

• One or More RF Tags in the Communications Range

After the Reader/Writer selects an RF Tag in the communications range, it returns the response without waiting for a timeout.

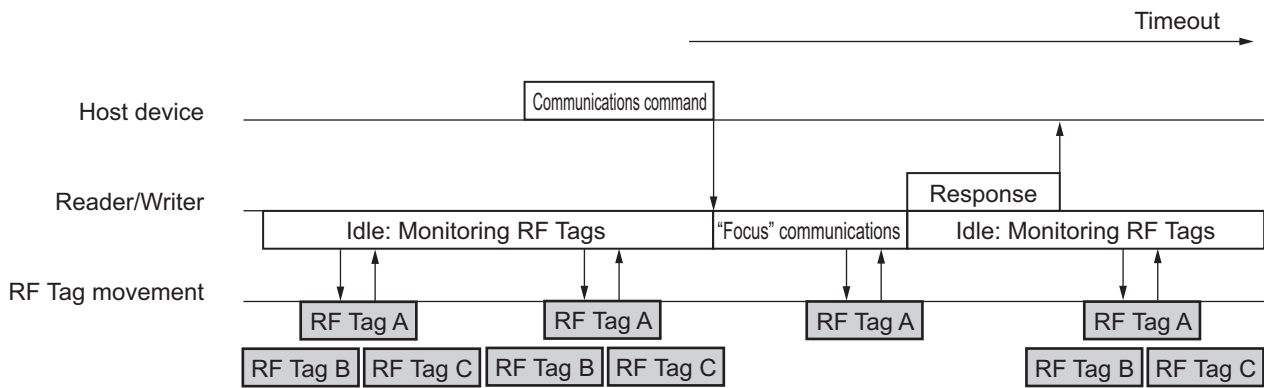

Additional Information

The behavior of the RF Tag that has communicated once with the Reader/Writer depends on the **Gen2 session** setting in the advanced RF communications settings. For details, refer to *Gen2 Session* on page 6-28.

• No RF Tag in the Communications Range

When the Reader/Writer does not detect a target RF Tag in the communications range, it waits for a timeout and then returns the communications results (RF Tag missing error).

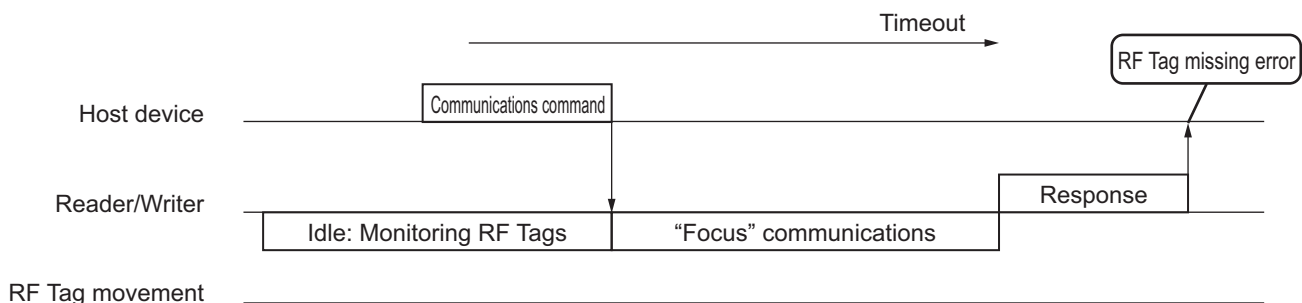

Repeat

When the Reader/Writer receives a command execution request from the host device, it automatically detects the entry of RF Tag in the communications field and communicates with it. This process is repeated until the command execution request is cleared. You can use this specification to perform communications with RF Tags in order as they move past the Reader/Writer.

The communication results of the RF Tags returned to the host device are not returned until the smoothing buffer becomes full. Once the command execution request is cleared, the smoothing buffer is cleared. The size of the smoothing buffer can be changed according to the settings.

● Single-access Operation

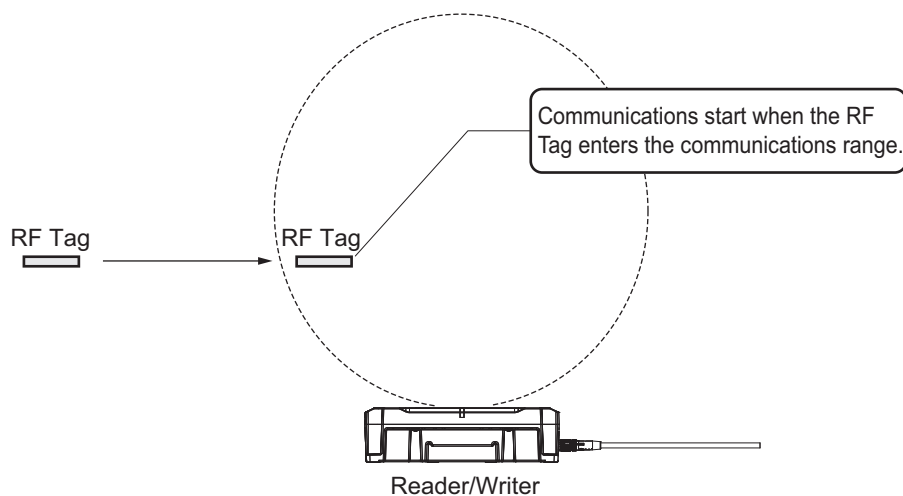

The Reader/Writer waits for an RF Tag to enter the communications range and returns the communications results after it detects an RF Tag.

The communications operation continues until the command execution request from the host device is cleared.

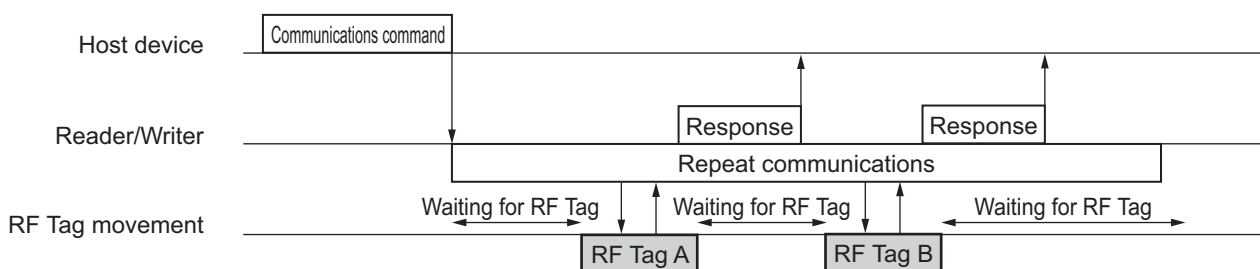

Additional Information

The behavior of the RF Tag that has communicated once with the Reader/Writer depends on the **Gen2 session** setting in the advanced RF communications settings. For details, refer to *Gen2 Session* on page 6-28.



Precautions for Correct Use

When the communications mode is "Repeat", no notice (error response) is sent to the host device even if an RF Tag missing error or communications error occurs.

● Multiaccess Operation

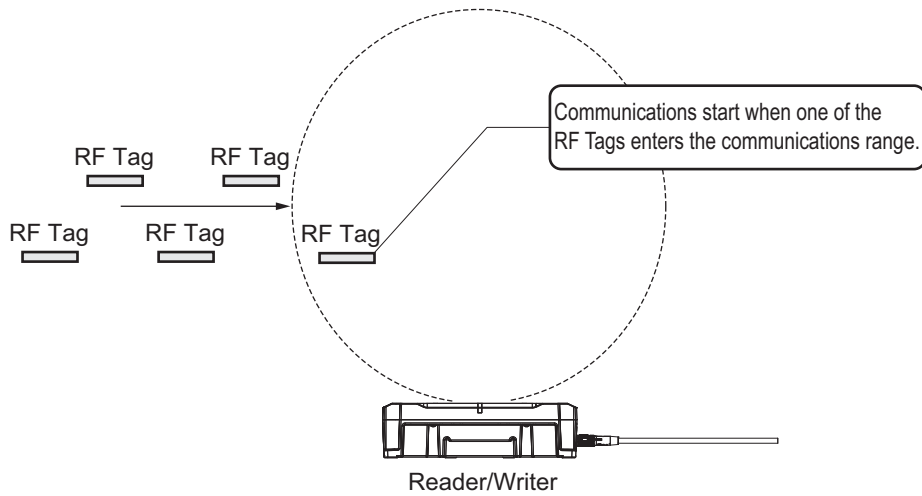

The Reader/Writer waits for multiple RF Tags to enter the communications range, and starts communications even if one RF Tag is detected. Each time the communications process is completed, the Reader/Writer returns a response. The communications operation continues until the command execution request from the host device is cleared.

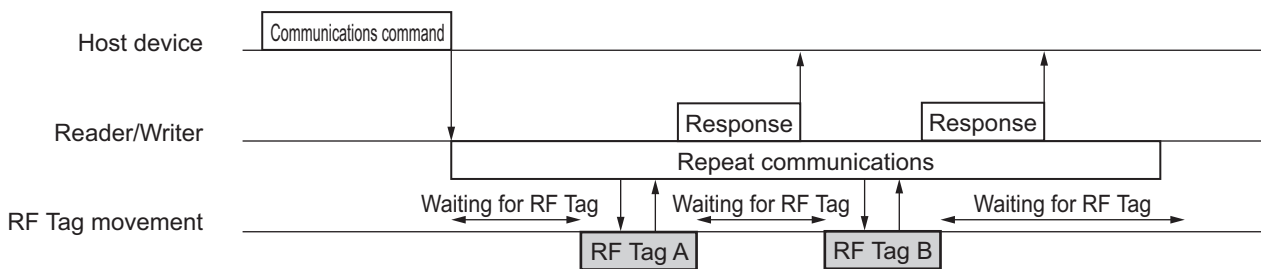

Additional Information

The behavior of the RF Tag that has communicated once with the Reader/Writer depends on the **Gen2 session** setting in the advanced RF communications settings.



Precautions for Correct Use

For details, refer to *Gen2 Session* on page 6-28

6-2-4 Communications Commands

The following table lists the communications commands. Depending on the communications command specified by the host device, single-access or multiaccess communications are performed with RF Tags.

Command name	Access method	Description
DATA READ	Single-access	Reads data from the memory of the RF Tag in the communications range.
DATA WRITE	Single-access	Writes data to the memory of the RF Tag in the communications range.
ID READ	Single-access	Reads the UII (EPC code) of the RF Tag in the communications range.
ID WRITE	Single-access	Writes the UII (EPC code) of the RF Tag in the communications range.
LOCK	Single-access	Locks the memory of the RF Tag in the communications range.
DATA FILL	Single-access	Writes the specified data to the specified number of words beginning from the specified write start address. The specifications are made in the command.
MULTIACCESS ID READ	Multiaccess	Reads the UIIs (EPC codes) of multiple RF Tags in the communications range.
MULTIACCESS DATA READ	Multiaccess	Reads data from the memory of multiple RF Tags in the communications range.



Precautions for Correct Use

Communications may not be performed correctly for single-access communications commands if there is more than one RF Tag in the communications range of the Reader/Writer. Use multi-access communications commands to communicate with more than one RF Tag.

RF Tag Access Range

UHF-band RFID RF Tags (compliant with EPC Global Class 1 Generation 2 standards) have four memory banks with independent offset addresses. For Reader/Writer communications commands, you combine the memory bank and offset address to specify the following addresses. All addresses from the Reader/Writer to access data in an RF Tag are given in words (2 bytes each).

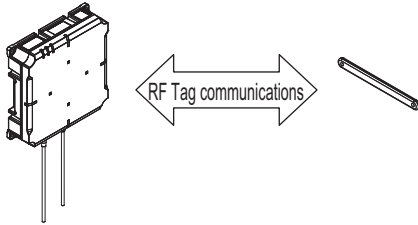

Reader/Writer command addresses (words)	RF Tag memory map		RF Tag memory area name
	Memory bank	Offset addresses (words)	
0000 hex ⋮ 07FF hex	Bank00	0000 hex ⋮ 07FF hex	Reserved (password and spare area)
1000 hex ⋮ 17FF hex	Bank01	0000 hex ⋮ 07FF hex	UII (EPC) area
2000 hex ⋮ 27FF hex	Bank10	0000 hex ⋮ 07FF hex	TID area
3000 hex ⋮ 3FFF hex	Bank11	0000 hex ⋮ 0FFF hex	User area

Command	Reserved area	UII (EPC) area	TID area	User area	Remarks
DATA READ	Supported	Supported	Supported	Supported	
DATA WRITE	Supported	Supported	Supported	Supported	
ID READ	Not supported	Restricted	Not supported	Not supported	Access is possible only to the StoredPC/UII (EPC) field in the UII (EPC) area.
ID WRITE	Not supported	Restricted	Not supported	Not supported	
LOCK	Supported	Supported	Supported	Supported	
DATA FILL	Supported	Supported	Supported	Supported	
MULTIACCESS ID READ	Not supported	Restricted	Not supported	Not supported	Access is possible only to the StoredPC/UII (EPC) field in the UII (EPC) area.
MULTIACCESS DATA READ	Supported	Supported	Supported	Supported	

Supported: All data can be accessed or locked, Restricted: Only specific parts can be accessed, Not supported: No data can be accessed.



Additional Information

Refer to A-3 *RF Tag Memory Map* on page A-17 for a detailed RF Tag memory map.

DATA READ

This command reads data from the memory of an RF Tag in the communications range.

- Specify the read start address and read size to specify the range to read.
- You can read up to 2,048 words (4 Kbytes) from each RF Tag memory bank.
- You cannot read data from more than one RF Tag memory bank at the same time.
- The actual address range that you can read from depends on the type of RF Tag that you use.
- With one command, you can read up to 512 words.
(The maximum data size varies depending on the data size of the tag set.)
- The following table shows the communications modes that you can specify for DATA READ.

Once	Auto	Focus	Repeat	Remarks
Supported	Supported	Supported	Supported	

Supported: Can be specified, Not supported: Cannot be specified.

DATA WRITE

This command writes data to the memory of the RF Tag in the communications range.

- Specify the write start address and write size to specify the range to write.
- You can write up to 2,048 words (4 Kbytes) from each RF Tag memory bank.
- You cannot write data to more than one RF Tag memory bank at the same time.
- The actual address range that you can write to depends on the type of RF Tag that you use.
- With one command, you can write up to 512 words.
(The maximum data size varies depending on the data size of the tag set.)
- The following table shows the communications modes that you can specify for DATA WRITE.

Once	Auto	Focus	Repeat	Remarks
Supported	Supported	Supported	Supported	

Supported: Can be specified, Not supported: Cannot be specified.

ID READ

This command reads the PC and UIIs (EPC codes) of the RF Tag in the communications range.

- The following data is read and is always 32 words: StoredPC field (1 word) and UII (EPC) field (31 words).
- The following table shows the communications modes that you can specify for ID READ.

Once	Auto	Focus	Repeat	Remarks
Supported	Supported	Supported	Supported	

Supported: Can be specified, Not supported: Cannot be specified.

ID WRITE

This command writes the UII (EPC code) of the RF Tag in the communications range.

- The code to write to the UII (EPC) field is specified with the write size and write data (1 to 31 words).
- The value specified for the write size is written as the UII (EPC) length in the StoredPC field.
- The following table shows the communications modes that you can specify for ID WRITE.

Once	Auto	Focus	Repeat	Remarks
Supported	Supported	Supported	Supported	

Supported: Can be specified, Not supported: Cannot be specified.

LOCK

This command locks the memory of the RF Tag in the communications range.

Use this command to write-protect the data in an RF Tag.

- Specify locking or unlocking for the lock operation.
- You can specify the UII (EPC) area, TID area, user area, or access password area as the area to lock or unlock.
- When an area is locked, the specified access password is written to the access password area in the RF Tag.
- A locked UII (EPC) area, TID area, or user area cannot be written to without specifying the access password.
- A locked access password area cannot be read or written to without specifying the access password.
- To unlock an area, the access password stored in the RF Tag must be specified.
- The following table shows the communications modes that you can specify for LOCK.

Once	Auto	Focus	Repeat	Remarks
Supported	Supported	Supported	Supported	

Supported: Can be specified, Not supported: Cannot be specified.

DATA FILL

This command writes the specified data to the specified number of words beginning from the specified write start address. The specifications are made in the command.

- The range to write is specified with the fill start address and fill size (2,048 words max.).
- The fill data specifies the value to write (2 bytes).
- If 0 is specified for the fill size, the entire memory bank is written.
- You cannot write data to more than one RF Tag memory bank at the same time.
- The actual address range that you can initialize depends on the type of RF Tag that you use.
- The following table shows the communications modes that you can specify for DATA FILL.

Once	Auto	Focus	Repeat	Remarks
Supported	Supported	Supported	Supported	

Supported: Can be specified, Not supported: Cannot be specified.

MULTIACCESS ID READ

This command reads the UIIs (EPC codes) of multiple RF Tags in the communications range.

- The following data is read and is always 32 words: StoredPC field (1 word) and UII (EPC) field (31 words).
- The following table shows the communications modes that you can specify for MULTIACCESS ID READ.

Once	Auto	Focus	Repeat	Remarks
Supported	Supported	Supported	Supported	

Supported: Can be specified, Not supported: Cannot be specified.

MULTIACCESS DATA READ

This command reads data from the memory of multiple RF Tags in the communications range.

- Specify the read start address and read size to specify the range to read.
- You can read up to 2,048 words (4 Kbytes) from each RF Tag memory bank.
- You cannot read data from more than one RF Tag memory bank at the same time.
- The actual address range that you can read from depends on the type of RF Tag that you use.
- You can read up to 32 words with one command.
- The following table shows the communications modes that you can specify for MULTIACCESS DATA READ.

Once	Auto	Focus	Repeat	Remarks
Supported	Supported	Supported	Supported	

Supported: Can be specified, Not supported: Cannot be specified.

Communications Commands and Error Codes

The errors that can occur for each communications command are given in the following table.

Command name	RF Tag missing error (2001 hex)	RF Tag communications failure (2002 hex)	RF Tag address error (2004 hex)	RF Tag lock error (2005 hex)	RF Tag Verification error (2006 hex)	RF Tag system error (2008 hex)	Password error (2009 hex)
DATA READ	Supported	Supported	Supported	Supported	Not supported	Supported	Supported
DATA WRITE	Supported	Supported	Supported	Supported	Supported	Supported	Supported
ID READ	Supported	Supported	Not supported	Not supported	Not supported	Supported	Not supported
ID WRITE	Supported	Supported	Not supported	Supported	Supported	Supported	Supported
LOCK	Supported	Supported	Not supported	Supported	Not supported	Supported	Supported
DATA FILL	Supported	Supported	Supported	Supported	Supported	Supported	Supported
MULTIACCESS ID READ	Supported	Supported	Not supported	Not supported	Not supported	Supported	Not supported
MULTIACCESS DATA READ	Supported	Supported	Supported	Supported	Not supported	Supported	Supported

Supported: Can occur, Not supported: Will not occur.

6-3 Reader/Writer Controls

This section describes the control functions of the Reader/Writer.

6-3-1 Initialization

You can return all of the settings in the Reader/Writer to the default settings with the INITIALIZE command or the **Configuration** Button on the Web browser interface.

6-3-2 Resetting

You can restart the Reader/Writer with the RESET command or with the **Reboot** Button on the Web browser interface. Restart the Reader/Writer when you change the network settings or any other settings that require restarting to be enabled. When the Reader/Writer acknowledges the reset request, it will return a response and then automatically restart itself.

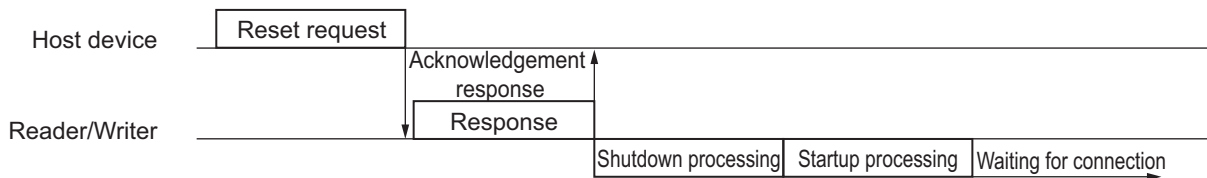

Normal Reset

When a command from the Reader/Writer is received, if the Reader/Writer operating status is other than “RF Tag communications in progress, Changing settings”, it will automatically restart itself.

- **Application:**

When reflecting user settings, switching operation modes, etc.

Forced Reset

When a command from the Reader/Writer is received, restart itself processing is performed regardless of the Reader/Writer operating status.

- **Application:**

Recovery when the Reader/Writer falls into an uncontrollable state, etc.

6-3-3 RESET FOCUS

You can use a RESET FOCUS command to clear the target level information in the Reader/Writer for all monitored RF Tags during operation in Focus Mode.

After the Reader/Writer completes reception of the RESET FOCUS command, it returns a response, clears the information, and then starts monitoring for RF Tags again.

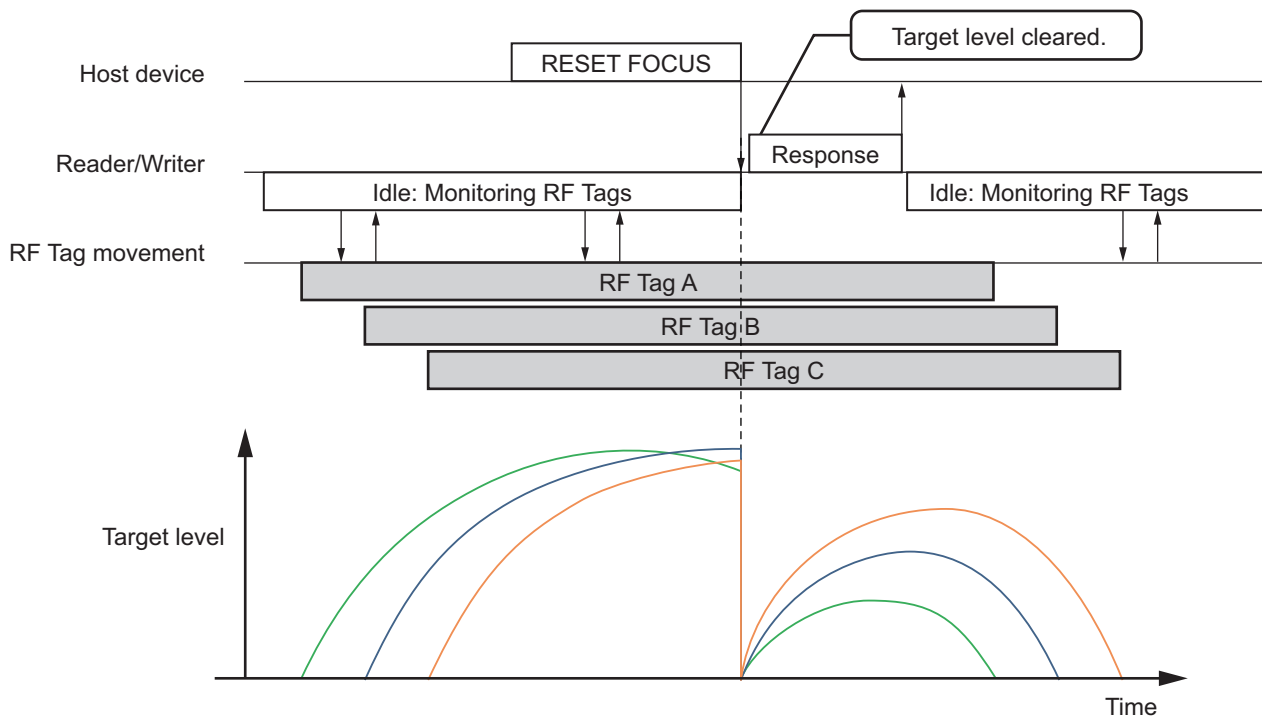

6-3-4 Installation Location Notification

Outline

You can use the operation indicators to find the installation location of a Reader/Writer.

When there is more than one Reader/Writer installed onsite, you can identify the Reader/Writer that is being manipulated from the Web browser interface.

Notification Method

You can flash the NORM/ERR indicators on a Reader/Writer by clicking the **Flash the LED** Button on the TCP/IP Settings Tab Page in the Network Settings View of the Web browser interface. The NORM/ERR indicators will flash cyan at a 0.1-s interval for 3 s.

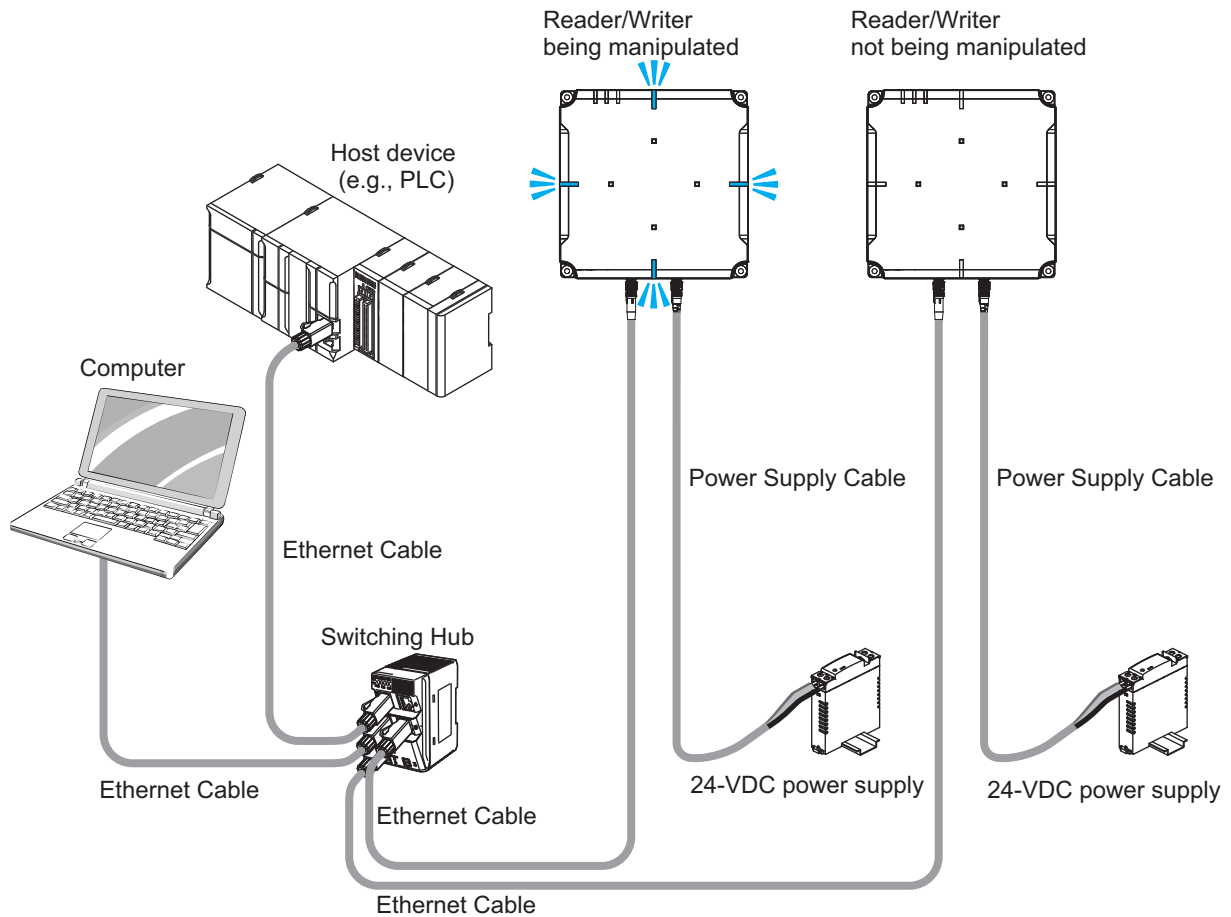

6-4 Reader/Writer Settings

You can use a setting command or a Web browser to set the operating conditions of the Reader/Writer according to the application environment. These settings are stored in non-volatile memory inside the Reader/Writer, so they are retained when the power supply to the Reader/Writer is turned OFF.

Setting classification	Description	Remarks
Network settings	You can set parameters related to the Ethernet interface on the Reader/Writer.	The Reader/Writer must be restarted to enable changes to these settings.
RF communications conditions: Basic Settings	You can set basic parameters for the operation of Reader/Writer communications with RF Tags.	Any changes to these settings are enabled immediately.
RF communications conditions: Advanced settings	You can set advanced parameters for the operation of Reader/Writer communications with RF Tags.	
Device settings	You can set parameters related to the operation of the Reader/Writer.	The Reader/Writer must be restarted to enable changes to these settings.

6-4-1 Network Settings

TCP/IP Settings

You can set a fixed IP address for the Reader/Writer or you can specify obtaining an IP address from a BOOTP server.



Precautions for Correct Use

If you change the IP address setting method from Fixed setting to Obtain from BOOTP server or Fix at the IP address which is obtained from BOOTP server, the IP address, subnet mask, and default gateway that are set for Fixed setting become 0. If necessary, perform a backup in advance.

Setting item	Description	Default
IP address setting method	<ul style="list-style-type: none"> • Fixed setting • Obtain from BOOTP server^{*1} • Fix at the IP address which is obtained from BOOTP server^{*2} 	Fixed setting
IP address	Fixed IP address	192.168.1.200
Subnet mask	The subnet mask is a value (IPv4) that is used to identify the network address and host address within the IP address.	255.255.255.0
Default gateway address	The IP address of the gateway to use to reach networks outside the one that the Reader/Writer is on.	192.168.1.254
Device name	A name that is used to identify the Reader/Writer on the network. It consists of up to 63 ASCII characters.	(Not set.)

*1. If you specify *Obtain from BOOTP server* for the IP address setting method, the Reader/Writer will ask the BOOTP server for an IP address setting every time it is started.

*2. If you specify *Fix at the IP address which is obtained from BOOTP server* for the IP address setting method, the Reader/Writer will ask the BOOTP server for an IP address setting only the first time that it is started after the setting was made. Thereafter, it will operate with a fixed IP address setting.

Port Settings

Setting item	Description	Default
Web port	The logical port number to use for TCP/IP communications with the client-side application on the Web browser interface.	7090

Web Password Setting

Setting	Description	Default
All zeros	No login password is set for the Web browser interface if the setting is all zeros.	All zeros
Not all zeros (any value)	Anything other than all zeros is treated as the password. The password can be up to 15 ASCII characters.	

6-4-2 RF Communications Conditions: Basic Settings

RF Communications Mode

You can select the communications mode to specify the operation of communications with RF Tags according to your environment or application.

Setting	Description	Default
Once	The Reader/Writer communicates with RF Tags when a command from the host device is executed.	Once
Auto	When the Reader/Writer receives a command from the host device, it automatically detects RF Tags in the antenna communications range and communicates with them.	
Focus	The Reader/Writer constantly monitors for RF Tags, focuses on one RF Tag in the antenna communications range, and diagnoses communications. When the Reader/Writer receives a command from the host device, it determines which RF Tag is in front of the Reader/Writer and communicates with it. Use Focus Mode to help prevent failure to read target RF Tags or reading unnecessary RF Tags.	
Repeat	After the Reader/Writer receives a command, it repeatedly communicates with the RF Tags and returns a response when communicating with an RF Tag was possible. Until the smoothing buffer becomes full, the Reader/Writer does not communicate with the RF Tag once communicated.	

RF Communications Speed

The RF communications speed setting can be used to change the speed of communications with RF Tags. You can thereby select whether to give priority to the communications time or to communications stability.

Setting	Description	Default
Auto speed	The Reader/Writer determines the communications speed for RF Tags based on interference conditions.	Auto speed
High speed	The communications speed for RF Tags is increased to reduce the communications time. However, this will make communications more susceptible to interference, such as from ambient noise.	
Normal speed	The communications speed for RF Tags is decreased to increase the stability of the communications quality. More time will be required for communications, but there will be more resistance to interferences, such as from ambient noise.	

RF Communications Timeout Time

The RF communications timeout time lets you specify an upper limit to the time required to process single-access or multiaccess communications. You can use this to provide leeway for details in detecting RF Tags in the communications range or to adjust the timing of when responses are returned.

Setting item	Description	Default
Timeout time	1 to 60,000 ms (in 1-ms increments)	250 ms

The RF communications timeout time is measured from when the Reader/Writer starts executing a communications command until an RF Tag is detected. If an RF Tag is not detected before the timeout time expires, an RF Tag missing error response is returned. If an RF Tag has already been detected when the timeout time expires, communications with that RF Tag are completed. (Communications after RF Tag detection will not be aborted for a timeout.)

Write Verification

The write verify setting can be used to automatically check the accuracy of written data for any communications command that writes data to an RF Tag.

Setting	Description	Default
Selected	After data is written to an RF Tag, the data is read to verify that the correct data was written. *1	Selected
Not selected	Verification is not performed after data is written to an RF Tag.	

*1. If verification shows that the read data is not the same as the write data, a verification error response is returned. The written data will not be changed. Write the original data again.

RF Communications Diagnostics

When a communications command is executed, communications diagnostics are performed to diagnose how much leeway there is in RF communications.

Monitoring status during operation helps create a more stable Reader/Writer and RF Tag installation.

Setting	Description	Default
Enable	Diagnostics are performed when communicating with an RF Tag and the results are displayed on the operation indicators and sent to the host device.	Disable
Disable	Diagnostics are not performed during RF Tag communications.	

*1. If you enable communications diagnostics, the communications time will be longer than when they are disabled.

6-4-3 RF Communications Conditions: Advanced Settings

Transmission Power

You can specify the transmission power for read communications and write communications. If you adjust the transmission power according to the communications distance, you can suppress radio wave interference and reduce reading non-target RF Tags.

Setting item	Description	Default
Tx power (Read)	The transmission power output during execution of read communications commands. 15 to 27 dBm (in 1-dB increments)	27 dBm
Tx power (Write)	The transmission power output during execution of write communications commands. 15 to 27 dBm (in 1-dB increments)	27 dBm

*1. The communications distance is shorter when writing data to an RF Tag in comparison with reading data from an RF Tag. The difference in the communications distance varies depending on the RF Tag.



Precautions for Correct Use

- Due to the surrounding environment, the intended RF tag may not be readable if the transmission power output is overly strong.

Channel

You can use the channel setting to select the channel (i.e., the frequency band) to use for execution of communications commands.

Use this setting to prevent mutual interference with nearby Reader/Writers and interference with other wireless devices.

Setting	V780-HMD68-EIP-□□	Default
Auto channel	The channel is automatically switched depending on the conditions of the Reader/Writer.	Auto channel
Specified Channel* ¹	This specifies the channel to use.	
V780-HMD68-EIP-JP	5CH: 916.8MHz 11CH: 918.0MHz 17CH: 919.2MHz	
V780-HMD68-EIP-IN	4CH: 865.7 MHz 7CH: 866.3 MHz 10CH: 866.9 MHz	
V780-HMD68-EIP-EU	4CH: 865.7 MHz 7CH: 866.3 MHz 10CH: 866.9 MHz 13CH: 867.5 MHz	
VV780-HMD68-EIP-RU	7CH: 866.3 MHz 10CH: 866.9 MHz 13CH: 867.5 MHz	

*1. The channel used can only be specified in models V780-HMD68-EIP-JP/-IN/-EU/-RU. The channel cannot be specified in the other models.



Additional Information

The channel number was defined in accordance with the regulations of the Japanese Radio Act.

Gen2 Session

The Gen2 session setting determines the length of time to hold the status of the RF Tag. The Reader/Writer communicates with an RF Tag and then sets a flag in the RF Tag after communications to indicate that it has been processed. The timing for retaining this flag depends on the session. We recommend that you normally use the default setting of S0.

Setting	Description	Default
S0	The status of the flag is not retained after power to the RF Tag is turned OFF. Use this setting to always process communications for each command for all RF Tags that are in the communications range.	S0
S1	The status of the flag is retained for 500 ms to 5 s regardless of whether the power supply to the RF Tag is turned ON or OFF. Use this setting to process communications at a set interval for the same RF Tags when a communications command is repeatedly executed.	
S2/S3	The status of the flag is retained for at least 2 s after power to the RF Tag is turned OFF. Use either of these settings to process communications only once when each RF Tag first enters the communications range when a communications command is repeatedly executed.	



Precautions for Correct Use

If you specify a stop time in the transmission time settings and then stop the output during RF Tag communications, you cannot use session S0 for multiaccess communications. If you specify S0 anyway, results may be returned more than once for the same RF Tag. (When the output is stopped, the status in the RF Tag is reset, so the “already processed” status is cleared.)

Access Password

You must specify the access password (8 hexadecimal digits) to the Reader/Writer to execute communications commands for an RF Tag with a locked memory area. If you attempt to execute a communications command without specifying the access password, a password error will occur.

- If the access password area in the memory of the RF Tag is not all zeros, the memory will be locked.
- If the UII (EPC) area, TID area, user area, or access password area in the memory of the RF Tag is locked, you must specify the access password to use write communications commands for the locked area.
- If the access password area in the memory of the RF Tag is locked, you must specify the access password to use a communications command (DATA READ) to read the area.

Setting	Description	Default
All zeros	An access password is not set. Access password verification is not required to communicate with the RF Tag.	00000000 hex (Not set.)
Not all zeros (any value)	An access password is set. Access password verification is required to communicate with the RF Tag.	

Transmission Time

You can specify the continuous transmission time to output radio waves continuously and the stop time to pause the output when the Reader/Writer communicates with an RF Tag.

By stopping the transmission output at specific intervals, you can suppress the influence of radio wave interference with nearby Reader/Writers.

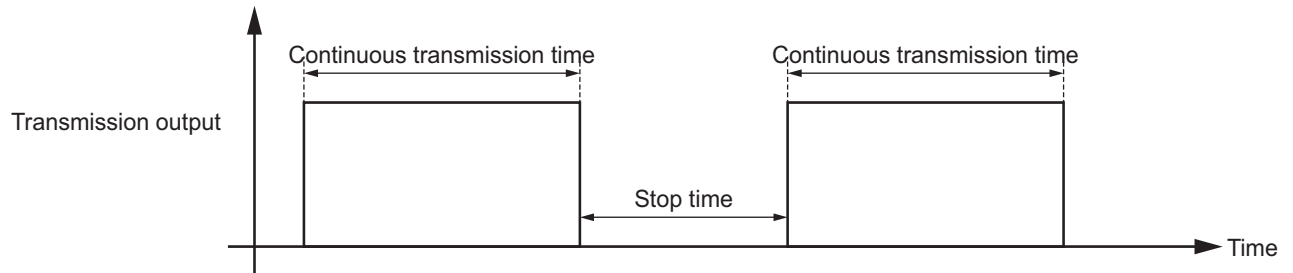

Setting	Description	Default
Continuous time	The maximum time to continuously output radio waves during communications commands execution	
V780-HMD68-EIP-JP	Infinite or 400 to 10,000 ms	Infinite
V780-HMD68-EIP-KR/-TW/-ID/ -MY/-SG/-US/-MX	400 ms (Fixed)	---
V780-HMD68-EIP-CN	2,000 ms (Fixed)	---
V780-HMD68-EIP-IN/-EU/-RU	4,000 ms (Fixed)	---
Stop time	The time to pause output during communications commands execution	
V780-HMD68-EIP-JP	None or 10 to 1,000 ms	None
V780-HMD68-EIP-KR/-CN/-TW/ -ID/-MY/-SG/-US/-MX	10 ms to 1,000 ms	10 ms
V780-HMD68-EIP-IN/-EU/-RU	100 ms to 1,000 ms	100 ms

RSSI Filter

The RSSI (received signal strength indicator) gives the strength level of the signal received from an RF Tag. (This is called the reception level.) If you set the reception level thresholds for the RSSI filter, communications will be performed only with RF Tags that have a reception level that is between the low and high thresholds

(Low threshold ≤ Reception level ≤ High threshold)

Use this to prevent reading non-target RF Tags.

Setting item	Description	Default
Disable	Filtering the reception level is not performed.	Disable
Enable	Filtering the reception level is performed.	
High threshold	0, or -70 to -10dBm (in 1-dB increments)	
Low threshold	0, or -70 to -10dBm (in 1-dB increments)	

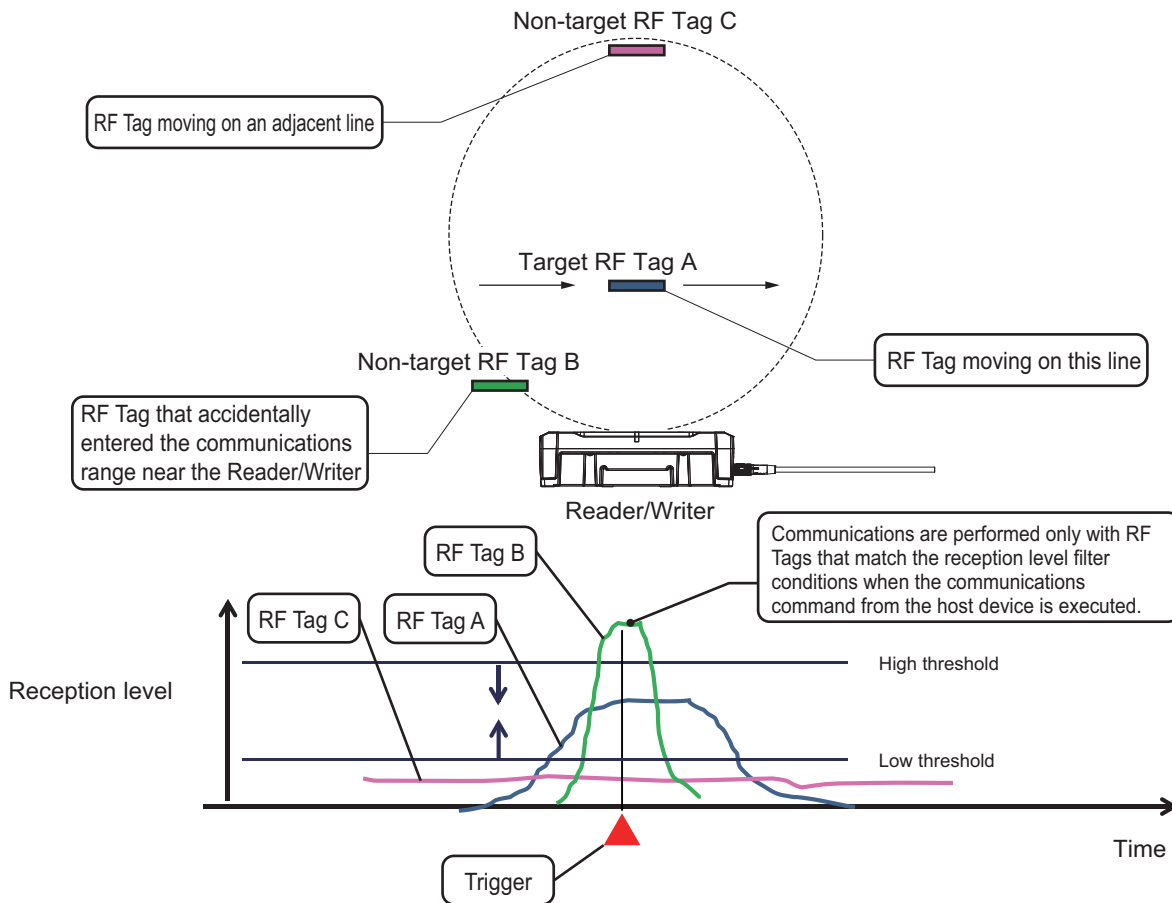

Smoothing Buffer

With the help of the smoothing buffer, the Reader/Writer does not return the communications result of the RF Tag that has been communicated once as a response to the host device. This reduces the network load and simplifies the host application processing. This function is enabled when the communications mode is "Repeat".

The number of RF Tags to be accumulated in the buffer is set. The buffered data is cleared when the command execution request is cleared (the EXE signal turns OFF). Alternatively, when the buffer size becomes full, the data is overwritten starting from the oldest data.

The smoothing buffer conditions during repeat can be set in the following range.

Item	Description	Default
Smoothing buffer conditions	0 to 1024 conditions * 0 implies that smoothing is disabled	1024



Precautions for Correct Use

When the number of RF Tags being buffered crosses 65, communications are stopped. Since communications are resumed when the number of RF Tags being buffered falls below 65, make sure that the host device acquires the response data from the Reader/Writer without delay.

RF Tag Selection Filter

The RF Tag selection filter can be used to verify data in any memory area of the RF Tag and communicate only with RF Tags that have matching data.

By communicating only with target RF Tags, communications efficiency is increased and reading non-target RF Tags can be prevented.

Setting item	Description	Default
Disable	Filtering is not performed with RF Tag data verification.	Disable
Enable	Filtering is performed with RF Tag data verification.	
Verification data	Specify the RF Tag memory address, verification data size, and verification data pattern. * You can specify up to 16 hexadecimal words in word increments for the verification data.	

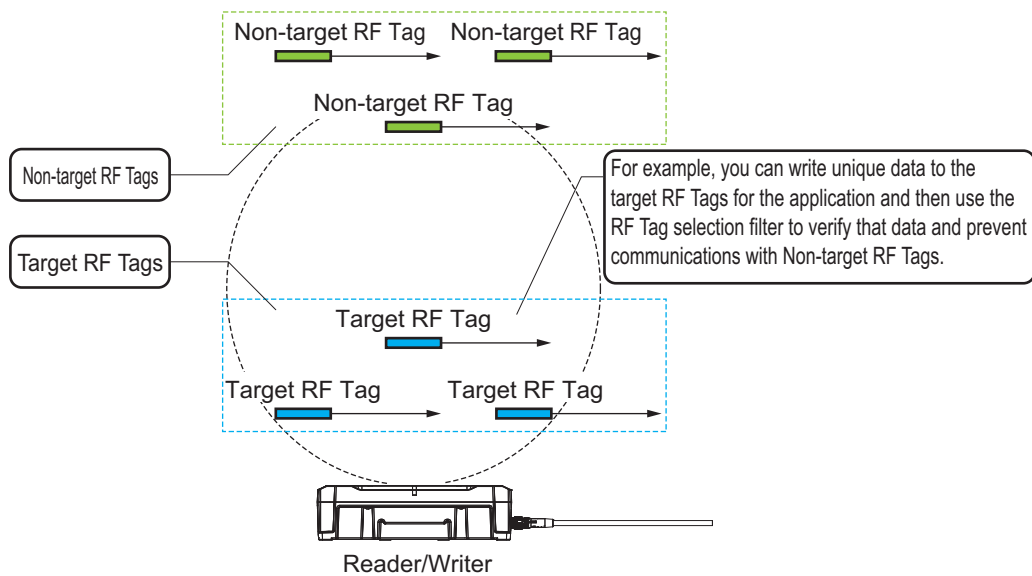

6-4-4 Device Settings

Operation Indicator Custom Settings

You can change the NORM/ERR indicator lighting pattern after Reader/Writer command execution. You can set one of eight lighting patterns: Lit in each of seven colors and OFF.

You can change only the NORM/ERR indicator lighting pattern that appears after command execution. You cannot change the lighting pattern for minor and major faults (lit red).

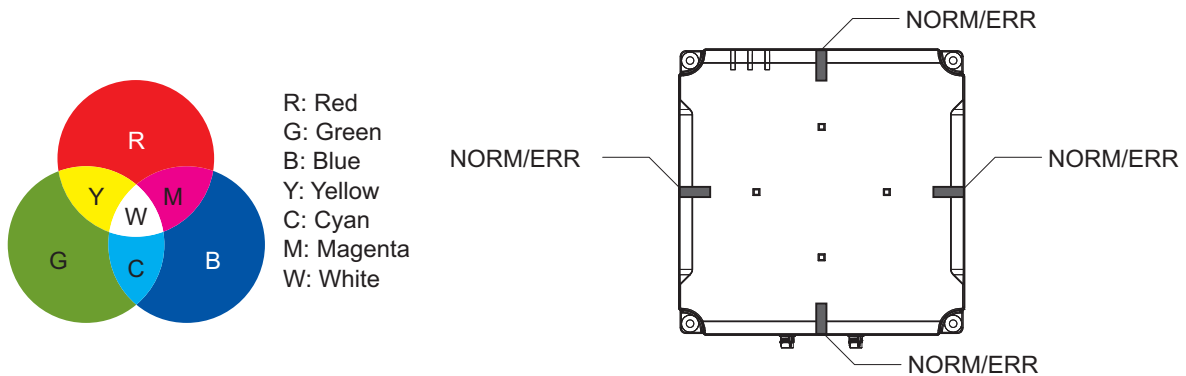

Precautions for Correct Use

The custom indicator settings are not used during test operation for tuning or utility functions performed from the Web browser interface. The indicators will light in the default colors.

Setting item	Description	Default
Command normal (NORM)	The indicators light with the specified lighting pattern when processing a communications command or another command from the host device is completed normally.	Lights green
Command error (ERROR)	The indicators light with the specified lighting pattern when processing a communications command or another command from the host device ends in an error.	Lights red
Unstable communications (WARNING)	The indicators light with the specified lighting pattern each time an unstable communication is detected while communications diagnosis is enabled.	Lights yellow

Multi-Reader/Writer Configuration Settings

It is possible to connect multiple Reader/Writers, and communicate with the RF Tags by setting the Multi-Reader/Writers.

It is possible to specify the Multi-Reader/Writer mode and a maximum of seven Reader/Writers as slave reader/writers.

The slave reader/writer (V780-HMD68-ETN-□□-S) and Standard Reader/Writer set to SLAVE mode can not change the multi reader/writer configuration setting.

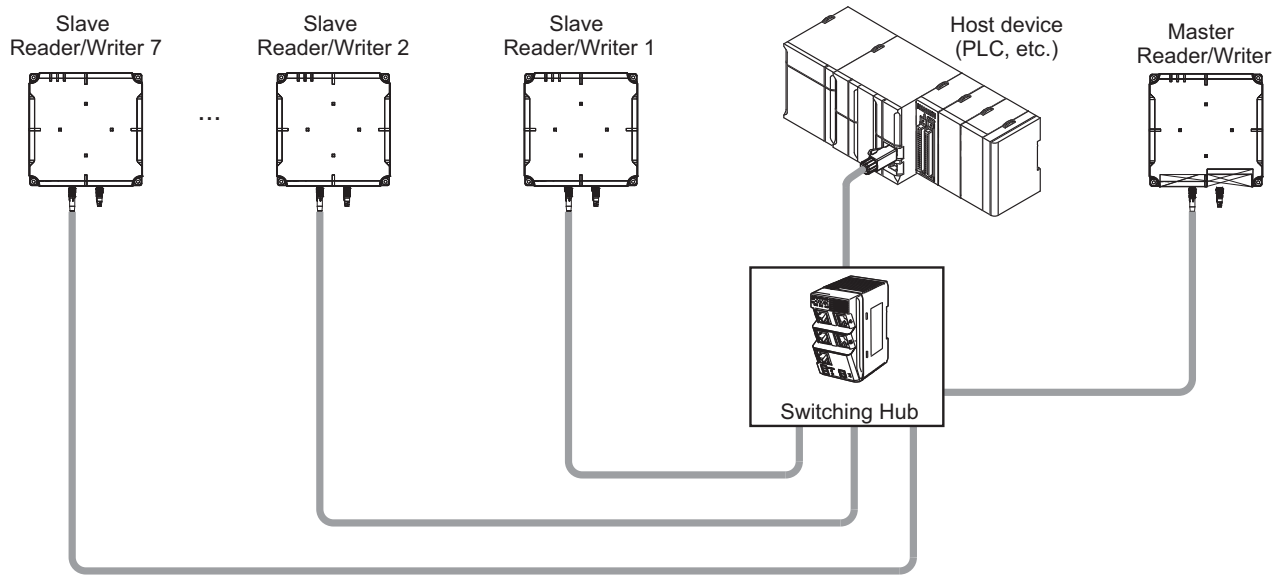

Setting item	Description	Default
Multi-Reader/Writer mode	Disabled: Communications are performed with a single Reader/Writer unit. Enabled: Communications are performed using multiple Reader/Writers.	Disable
Number of Slave Reader/Writers	This specifies the number of slave Reader/Writers.	0
Slave Reader/Writer 1 IP Address	This specifies the IP address of the Reader/Writer registered as the slave reader/writer.	0.0.0.0
Slave Reader/Writer 2 IP Address		0.0.0.0
Slave Reader/Writer 3 IP Address		0.0.0.0
Slave Reader/Writer 4 IP Address		0.0.0.0
Slave Reader/Writer 5 IP Address		0.0.0.0
Slave Reader/Writer 6 IP Address		0.0.0.0
Slave Reader/Writer 7 IP Address		0.0.0.0

6-4-5 Exporting/Important Configuration Files

From the Web browser interface, you can output a file of all Reader/Writer settings and save them on your computer (export). You can also read a configuration file and write it to the Reader/Writer from the Web browser interface (import). The configuration file is in INI file format.

The slave reader / writer (V780-HMD68-ETN-□□-S) and Standard Reader/Writer set to SLAVE mode can not import/export “Multi reader/writer setting” of the setting file.



Additional Information

For details, refer to *Operation Indicator Custom Settings* on page 8-13.

6-5 Maintenance: Device Information

6-5-1 Reading Device Information

You can use a command or the Web browser interface to check the device information in the Reader/Writer.

Item	Description	Remarks
Model	The model number of the Reader/Writer.	
Firmware version	The firmware version in the Reader/Writer.	
MAC address	The MAC address that is assigned to the Reader/Writer.	



Additional Information

For details, refer to *8-2-2 Status* on page 8-5.

6-5-2 Getting the Operating Status

You can use a command or the Web browser interface to check the current operation mode and status of a Reader/Writer.

Item	Description	Remarks
Operation mode	The operation mode of the Reader/Writer. The operation mode is either Run Mode or Safe Mode.	
Status	The status of the Reader/Writer. The status can be idle (waiting for a command), RF communications in progress, changing settings, or system error.	



Additional Information

For details, refer to *8-2-2 Status* on page 8-5.

6-5-3 Getting and Setting Time Information

You can use a command or the Web browser interface to check or set the time information in the Reader/Writer.

The clock information is not retained when the power supply is turned OFF. Use a command to reset the clock information when you turn ON the power supply.

Item	Description	Remarks
Time information	The time information is handled in the following format: HH/MM/SS. If the time information is not set from the host device, the elapsed time from when the Reader/Writer was started will be given.	Calendar information (YY/MM/DD) is not supported. The time accuracy is ± 39 s per month.



Additional Information

For details, refer to *8-2-2 Status* on page 8-5.

6-6 Maintenance: Log Information

6-6-1 Getting and Clearing the System Error Log

You can access the system error log that is maintained in the Reader/Writer.

You can read the system error log by sending a command from the host device or by using the Web browser interface.

- The system error log contains up to 15 fatal errors that were detected by the Reader/Writer during operation. They are given in chronological order.
- If more than 16 errors occur, the oldest errors are deleted in order.
- The system error log is retained in memory inside the Reader/Writer even after the power supply is turned OFF.
- You can also clear the log.
- The following record information is stored in the system error log.

Item	Description	Remarks
Time	This is the time when the system error was detected by the Reader/Writer.	
Error code	This code is used to identify the error.	Errors classified as minor faults and major faults are recorded.
Attached information 1	These codes provide additional information on the error.	For details, refer to <i>9-3 Errors and Countermeasures</i> on page 9-8.
Attached information 2		

6-6-2 Getting the Command Error Log

You can access the command error log that is maintained in the Reader/Writer.

You can read the command error log by sending a command from the host device or by using the Web browser interface.

- The command error log records up to eight records of information on host device command executions that ended in errors in chronological order.
- If more than 9 errors occur, the oldest errors are deleted in order.
- The command error log is deleted when the power supply to the Reader/Writer is turned OFF.
- The following record information is stored in the command error log.

Item	Description	Remarks
Time	This is the time when the Reader/Writer returned an error completion response to the host device.	
IP address of device that sent the command	This is the IP address of the host device that sent the command.	
Command code	This code is used to identify the command.	
Error code	This code is used to identify the error.	Errors that are classified as command errors or RF Tag communications errors are recorded.
Reader/Writer Number	This shows the number identifying the Reader/Writer where an error has occurred when the Multi-Reader/Writer function is enabled.	Master Reader/Writer: 0 Slave Reader/Writers 1 to 7
Attached information 1	These codes provide additional information on the error.	For details, refer to <i>9-3 Errors and Countermeasures</i> on page 9-8.
Attached information 2		

6-6-3 Getting the Most Recent Command Error Information

You can access information on the last command for which Reader/Writer processing ended in an error.

You can read the most recent command error information by sending a command from the host device or by using the Web browser interface. The most recent command error information is deleted when the power supply to the Reader/Writer is turned OFF.

You can get the following most recent command error information.

Item	Description	Remarks
Time information	This is the time when the Reader/Writer returned an error completion response to the host device.	
IP address of device that sent the command	This is the IP address of the host device that sent the command.	
Command code	This is the code that identifies the command that was executed.	
Error code	This code is used to identify the error.	
Reader/Writer Number	This shows the number identifying the Reader/Writer where an error has occurred when the Multi-Reader/Writer function is enabled.	Master Reader/Writer: 0 Slave Reader/Writers 1 to 7
Response information 1	These codes provide additional information on the error.	
Response information 2		

6-7 Maintenance: Communications Information

6-7-1 Getting the Reception Level

You can access the reception level that was measured by the Reader/Writer while processing communications with an RF Tag. You can get the reception level information by sending a command from the host device or by using an option specification for a communications command.

- The reception level information is valid only when the communications command ended normally.
- If the communications command ended in an error, a value of 0 will be returned.

Item	Description	Remarks
Reception level	-35 to -61 dBm ^{*1}	A value of 0 dBm will be returned if processing ended in an error.

*1. Values outside of the above range may be detected under some conditions.

6-7-2 Getting the Noise Level

You can measure the noise level in the environment around the Reader/Writer for each frequency channel. You can get the noise level information by sending a command from the host device.

Item	Description	Remarks
Noise level	-35 to -70 dBm ^{*1}	

*1. Values outside of the above range may be detected under some conditions.

6-7-3 Communications Diagnostics

Outline

This function diagnoses the communications leeway whenever the Reader/Writer communicates with an RF Tag, displays the results on an operation indicator, and reports the results to the host device.

With a UHF RFID system, the communications performance is affected by various environmental factors (e.g., installation distance between Reader/Writer and RF Tag, installation objects, and radio wave interference from other wireless devices). You can use the communications diagnostics to check the leeway in communications and achieve more stable RFID system operation.

The communications diagnostics information reports three main results: stable communications, unstable communications, and communications errors.

The NORM/ERR operation indicators light green for a stable communication, yellow for an unstable communication, and red for a communications error.

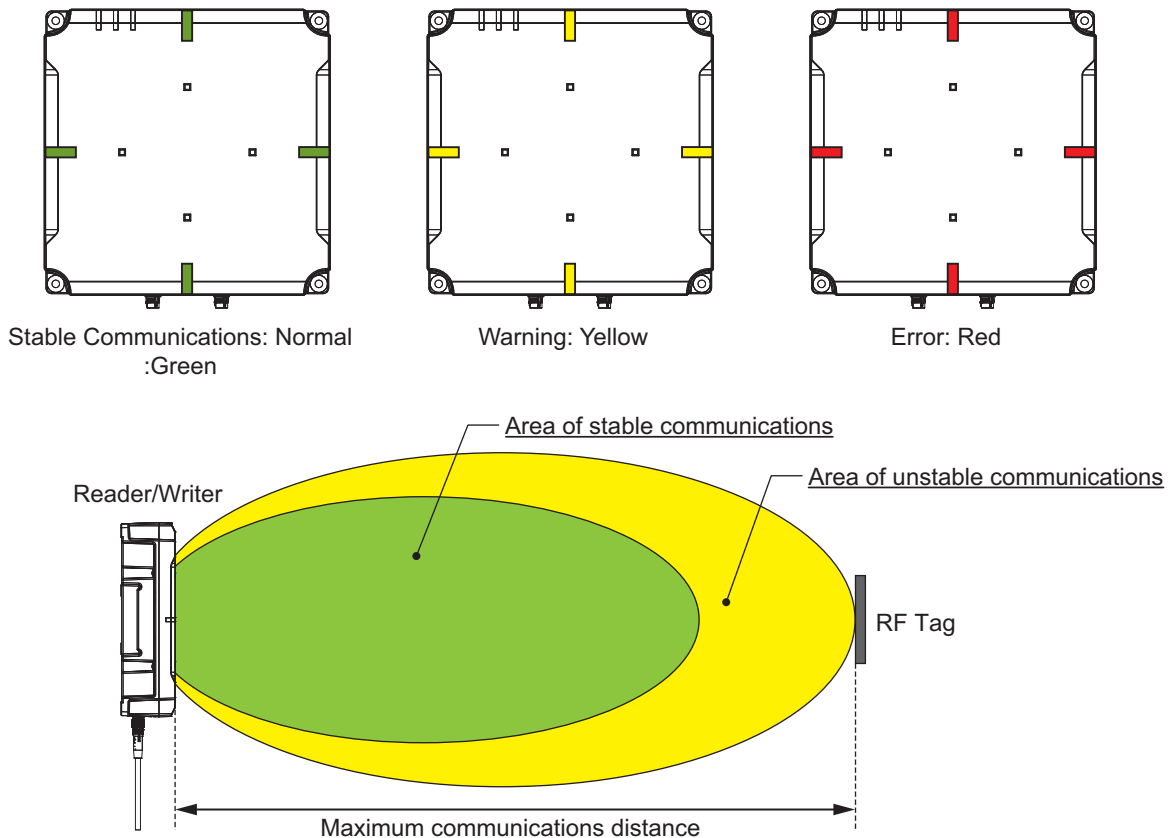



Precautions for Correct Use

- Use the results of communications diagnosis as a guideline. An indication of a stable communication (green) does not necessarily mean that communications are normal.
- An indicator of an unstable communication (yellow), does not necessarily mean that communications are not possible. It merely means that there is little leeway in communications. If you want to ensure more stable communications, we recommend that you use the Reader/Writer so that stable communications (green) are indicated.
- If you enable communications diagnostics, the communications times will be increased by up to 100 ms.
- Communications diagnostics are performed during single-access communications commands. Diagnosis is not performed for multiaccess commands.
- The communications performance in the UHF band is affected by ambient objects, such as metal objects. Therefore, perform sufficient testing in advance of actual system operation.
- RF Communications Diagnostics is disabled when Multi-Reader/Writer Function is enabled. For details, refer to “6-10-4 Communications conditions during Multi-Reader/Writer use”.

Diagnostics

Communications diagnostics give the following diagnostic results when communications are unstable.

Notification priority	Diagnostic result	Description	Remarks
High	A: Insufficient power to send	Indicates that the signal strength of the signal sent from the Reader/Writer to the RF Tag was weak.	
	B: Insufficient power to receive	Indicates that the signal strength of the signal returned from the RF Tag to the Reader/Writer was weak.	
	C: Too much noise	Indicates that the noise level around the Reader/Writer was too high.	
	D: Insufficient read data	Indicates that there was an insufficient number of successful communications with a target RF Tag that entered the communications range of the Reader/Writer, i.e., that there is no leeway in distinguishing the target RF Tag.	Diagnostic processing for these results is performed only in Focus Mode.
Low	E: Excessive read data	Indicates that the influence of a non-target RF Tag in Reader/Writer communications range prevented verifying the target RF Tag.	

You can use communications diagnosis to detect deterioration of performance for the following conditions. Use the diagnostic result to infer the cause and implement countermeasures.

Diagnostic result	Possible cause	Workaround
A/B	Communications performance was reduced by an excessive communications distance between the Reader/Writer and RF Tag.	Place the RF Tag closer to the Reader/Writer.
A/B	Communications performance was reduced because the RF Tag was inclined in relation to the Reader/Writer.	Mount the RF Tag so that it faces the Reader/Writer.

Diagnostic result	Possible cause	Workaround
A/B	Communications performance was reduced because the position of the RF Tag was offset in relation to the Reader/Writer.	Communicate with the RF Tag when it is in front of the Reader/Writer.
A/B	Communications performance was reduced because of the influence of metal around the RF Tag.	Remove all metal from around the RF Tag. * If the recommended RF Tag (V780-A-JIME-BLI-10) is mounted on a metallic material, install it on an Attachment (V780-A-TA-133-10).
A/B	Communications performance was reduced because of the influence of metal around the Reader/Writer.	Remove all metal from around the Reader/Writer. * Metal behind the Reader/Writer will not influence performance.
A/B/C/E	Communications performance was reduced due to the influence of reflected radio waves.	Change the position of physical structures or the Reader/Writer and find the best radio wave environment.
C	Communications performance was reduced by the influence of radio wave interference from a wireless device near the Reader/Writer.	Move wireless devices away from the Reader/Writer.
C	Communications performance was reduced by the influence of interference from a low-frequency device near the Reader/Writer.	Move low-frequency devices away from the Reader/Writer.
D	The RF Tag is traveling too quickly.	Reduce the speed of the RF Tag.
E	The RF Tags are too close to each other.	Separate the RF Tags farther from each other.

Getting RF Communications Diagnostic Information

You can check information on measurements and diagnostics that were performed in RF Tag communications for the last communications command that was executed by the Reader/Writer.

You can check the communications diagnostic information by sending a command from the host device.

The following table lists the information that you can get in the communications diagnostic information.

Item	Description	Remarks
Time	Indicates the time that the Reader/Writer communicated with the RF Tag.	
Command code	Indicates the code that identifies the communications command that was executed.	
Communications result (error code)	Indicates the code that identifies the communications command that was executed.	
Diagnostic result	Indicates the code that identifies the result of communications diagnostics. Communications normal, communications error, insufficient power to send, insufficient power to receive, too much noise, insufficient signal-to-noise ratio, insufficient read data, or excessive read data	
Diagnostic details	Indicates all diagnostic results detection status as bit information.	

Item	Description	Remarks
Channel used	Indicates the channel used when communicating with an RF Tag.	Indicates the channel selected by a Reader/Writer when the channel setting is "Automatic."
Communications speed	Indicates the communications speed when communicating with an RF Tag.	Indicates the speed selected by the Reader/Writer when the communications speed setting is "Automatic."
Reception level	Indicates the reception level measured during communications diagnostics. -35 to -61 dBm ^{*1}	
Noise level	Indicates the noise level measured during communications diagnostics. -35 to -70 dBm ^{*1}	
Target level	Indicates the target level measured during communications diagnostics. 0 to 100	This value is input only in Focus Mode.
StoredPC UII (EPC code)	Indicates the UII (EPC code) (including the StoredPC data) of the RF Tag that was communicated with during communications diagnostics.	

*1. Values outside of the above range may be detected under some conditions.

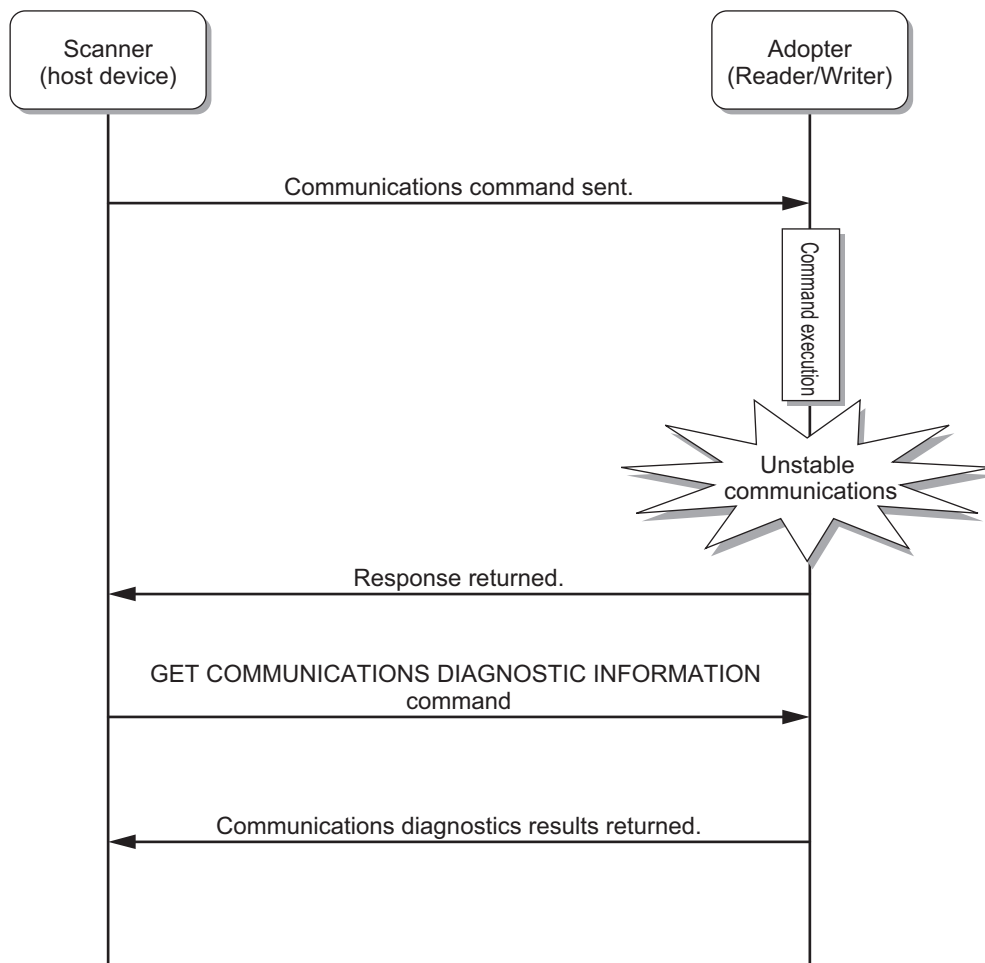

Accessing the RF Communications Diagnostics Log

You can access the information that resulted from communications diagnostics from the communications diagnostics log displayed on the Web browser interface. You can easily check to see how stable communications are and troubleshoot problems.

- The communications diagnostics log stores up to 8,192 records in time sequence of the information that resulted from diagnostics during execution of communications commands from the host device.
- If more than 8,192 records occur, the oldest records are deleted in order.
- The communications diagnostics log is deleted when the power supply to the Reader/Writer is turned OFF.

You can browse a list of diagnostic information and periodically confirm the leeway quantitatively on graphs from the Web browser interface. If you select the record in the list, details will be displayed along with the probable causes and workarounds. You can save a log file that contains the diagnostic information stored in the Reader/Writer for your usage.

Diagnostic Information Table Display

Log view

Command error log System error log **RF communications diagnostics log**

Total: 100 Warning: 5 Error: 6

No	Time	Command	Result	Diagnostics result	UID(EPC)
1	0:2:43	ID read	Normal	Normal	1234567E
2	0:3:23	ID read	Warning	Insufficient power to receive	1234567E
3	0:3:42	ID read	Warning	Too much noise	1234567E
4	0:3:50	ID read	Error	RF Tag missing error	
5	0:4:46	ID read	Normal	Normal	1234567E
6	0:4:47	ID read	Normal	Normal	1234567E
7	0:4:47	ID read	Normal	Normal	1234567E
8	0:4:48	ID read	Normal	Normal	1234567E

No: 2
 Command: 0001: ID read
 Diagnostics result: 0002: Insufficient power to receive
 Diagnostic details:
 Used channel: 0x0002
 RF speed: High speed
 Noise level: -50dBm
 Target level: 0

The strength of the signal returned from the RF Tag to the Reader/Writer was weak.

[Probable cause/Workaround]
1

Update Save Clear

Diagnostic Information Graph

Log view

Command error log System error log **RF communications diagnostics log**

Total: 100 Warning: 5 Error: 6

Reception level Noise level

10
-10
-20
-30
-40
-50
-60
-70

1 2 3 4 5 6 7 8 9 10 11 12 13 14 15 16 17 18 19 20 21 22 23 24 25 26 27 28 29 30 31 32 33 34 35 36 37 38 39 40 41 42 43 44 45 46 47 48 49 50 51 52 53 54 55 56 57 58 59 60 61 62 63 64 65 66 67 68 69 70 71 72 73 74 75 76 77 78 79 80 81 82 83 84 85 86 87 88 89 90 91 92 93 94 95 96 97 98 99 100

1/1

Update Save Clear

Operation indicator

Reboot

configuration

6-8 Tuning

6-8-1 Transmission Power Tuning

Outline

You can measure the transmission power that is required for the Reader/Writer to communicate with an RF Tag and then adjust the transmission power.

You can set the optimum transmission power for communications with target RF Tags, i.e., the minimum required power. You can use this to prevent communicating with RF Tags you do not want to communicate with or to suppress interference with other Reader/Writers, and thereby achieve more stable RFID system operation.

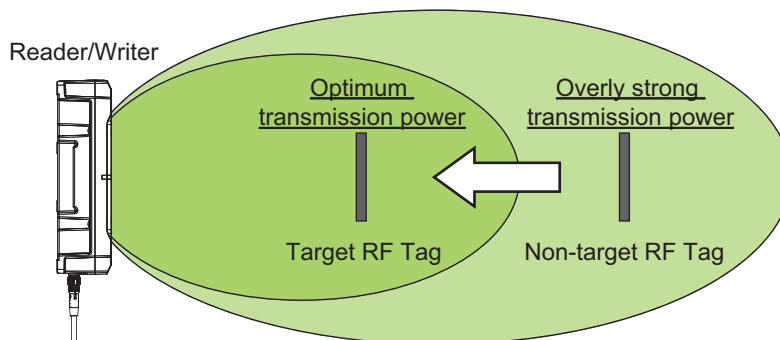

You can use the Transmission Power Tuning View on the Web browser interface to adjust the transmission power settings separately for reading and writing. When you adjust these settings from the Web browser interface, use the actual RF Tags at the same communications distance as the application. When the Reader/Writer is adjusted, it sweeps through the range of transmission powers and measures the communications status while actually reading and writing data in the RF Tag. Finally, the measurement results are used to provide information on the optimum transmission power.

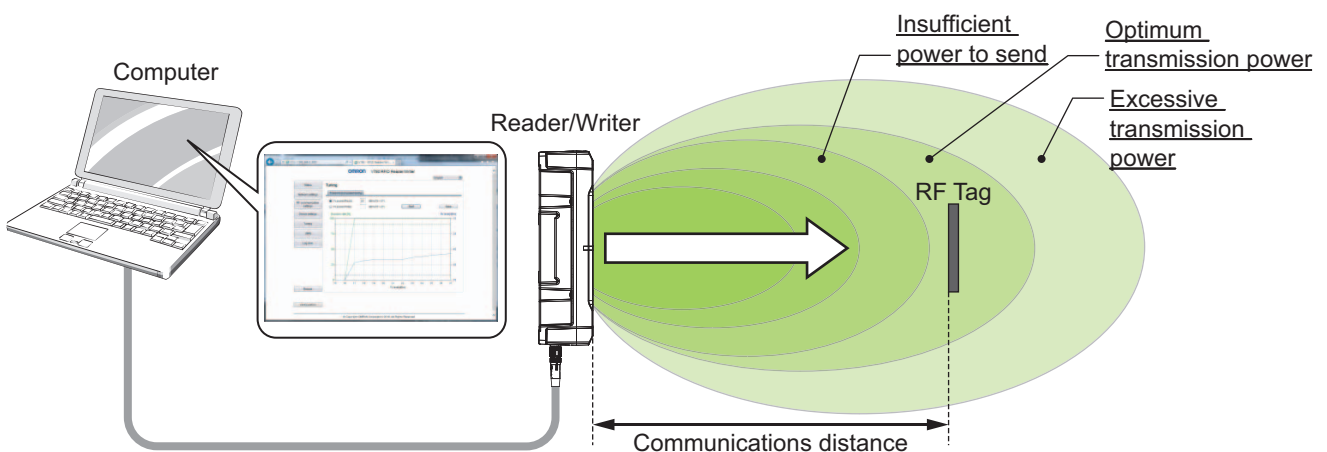



Precautions for Correct Use

- The RUN indicator will light cyan during adjustment.
- For the adjustment, place the RF Tag at the farthest distance from the Reader/Writer that would be normal in the actual application.
- Do not move the RF Tag during adjustment. Doing so will prevent determining the optimum power.
- When you use this function, use the same RF Tag that you will use in actual operation. If you change the type of RF Tag, the adjustment results will differ.
- When the write transmission power is automatically adjusted, data is actually written to the RF Tag.
- Any RF Tag communications errors that are detected as a result of communications with RF Tags during adjustments are recorded in the command error log.
- If you close the Web browser interface or disconnect the communications cable during the adjustment, the test operation status (i.e., the RUN indicator lit in cyan) may continue. If that occurs, cycle the power supply to the Reader/Writer to reset it.

Transmission Power Adjustment Procedure

From the Transmission power tuning View, select either the read or write option for the transmission power adjustment.

Then, click the **Start** Button. Tuning automatically sets the optimum transmission power. You can also save the transmission power adjustment results to a file.

● Transmission Power Tuning View

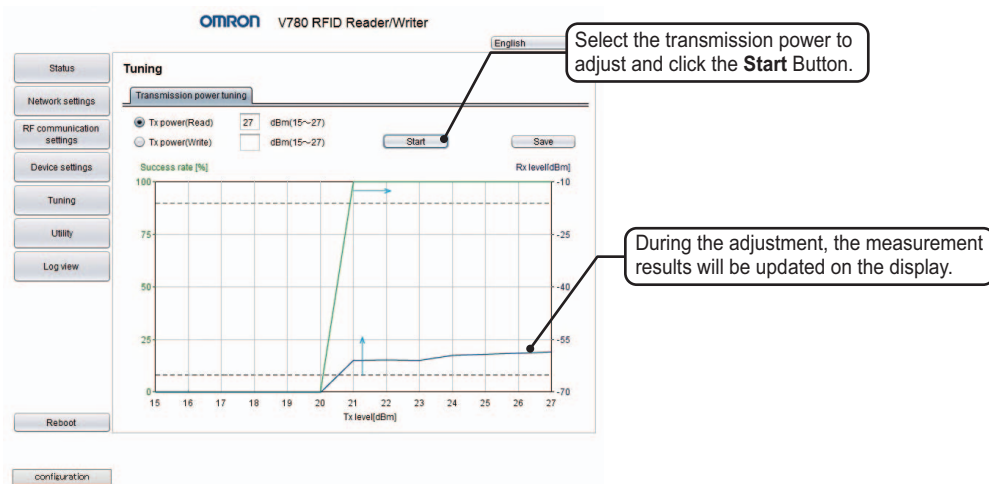

● **Transmission Power Adjustment Failure**

If the communications status changes as shown below during transmission power adjustment, adjustment has failed. Correct the installation environment and perform the adjustment again.

a) Communications Success Rate or Reception Level Is Below the Threshold

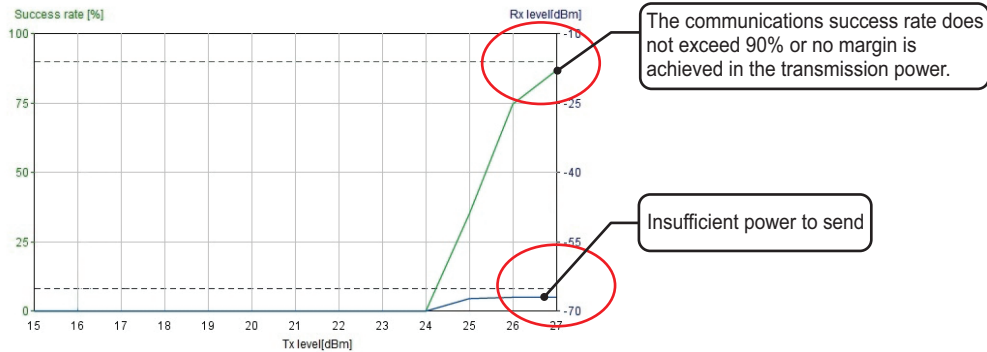

b) Communications Success Rate or Reception Level Exceeds the Threshold Then Goes Below It One or More Times



6-9 Utilities

6-9-1 RF Tag Access

Outline

You can check communications between the Reader/Writer and host device for RF Tag communications commands.

You can specify the UII (EPC code) or any address in the RF Tag to access the data.

RF Tag Access Method

The RF Tag Access View displays the communications commands sent to the Reader/Writer and the response that is received.

To start a test, select a communications command from the **RF communication command** Box and enter the parameters required for the command.

After the communications command is sent, the response from the RF Tag is displayed. If communications diagnostics are enabled, the diagnostic results are also displayed.

The time required to communicate with the RF Tag is also displayed.



Precautions for Correct Use

- You can select any of the following communications commands on the Web browser interface.

Communications command	Data address field	Data size field	Write data field
ID READ	Not used. (Grayed out.)	Not used. (Grayed out.)	Not used. (Grayed out.)
ID WRITE	Not used. (Grayed out.)	Not used. (Grayed out.)	Used. (Can be entered.)
DATA READ	Used. (Can be entered.)	Used. (Can be entered.)	Not used. (Grayed out.)
DATA WRITE	Used. (Can be entered.)	Not used. (Grayed out.)	Used. (Can be entered.)

- You can also manually enter any command and send it.



Precautions for Correct Use

- The RUN indicator will light cyan during the scan.
- During a scan, the NORM/ERR indicators will flash once in red or green according to the results of multiaccess communications.
- During the scan, the Reader/Writer will repeatedly communicate with the RF Tags to read the IDs with multiaccess communications.
- The scan list is updated approx. every 1.5 s.
- If you close the Web browser interface or disconnect the communications cable during scanning, the test operation status (i.e., the RUN indicator lit in cyan) may continue. If that occurs, cycle the power supply to the Reader/Writer to reset it.

6-9-3 Reception Level Monitor

Outline

You can check the reception level from RF Tags over time on a graph.

You can use this to adjust the installation locations of Reader/Writers and RF Tags and measure the communications ranges to achieve more stable RFID system operation.

Broadly speaking, you can use the Reception Level Monitor View to analyze two communications methods: single-access communications and multiaccess communications. You can also save the reception level information measured by the reception level monitor in a file.

Measurement Method for Single-access Communications

To analyze communications with individual RF Tags with the reception level monitor, select the *Single* Option and then click the **Start** Button. When analysis begins, the Reader/Writer will start taking measurements and the reception level display for the RF Tag will be updated in realtime. To stop taking measurements, click the **Stop** Button.

● Reception Level Monitor View

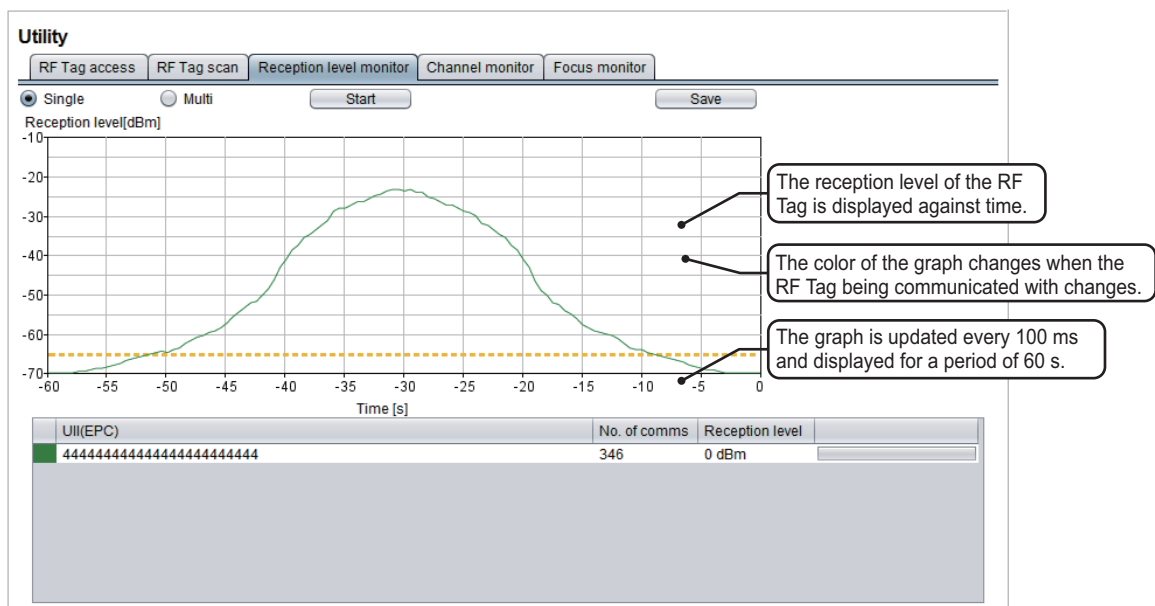















Precautions for Correct Use

- The RUN indicator will light cyan during the measurements.
 - During the measurements, the Reader/Writer will repeatedly communicate with the RF Tag to read the ID.
 - The reception level graph is updated every 100 ms and displayed for a period of 60 s.
 - You can use the **Save** Button to download up to 1,800 measurements (100 ms x 1,800 measurements = 180 s, or 3 min).
 - If you close the Web browser interface or disconnect the communications cable during the measurements, the test operation status (i.e., the RUN indicator lit in cyan) may continue. If that occurs, cycle the power supply to the Reader/Writer to reset it.
-

● Flashing Speed of NORM/ERR Indicators

During measurements of single-access communications, operation indicators will flash and the flashing speed will indicate the reception level of the Reader/Writer. This allows you to install and adjust the Reader/Writer and RF Tags even if you cannot see the Reception Level Monitor View on the Web browser interface.

Operation indicators	Color	Status	Description
NORM/ERR	Green	 Flashing at 100-ms intervals	Communications processing ended normally with a reception level between -35 and -37 dBm.
	Green	 Flashing at 200-ms intervals	Communications processing ended normally with a reception level between -38 and -40 dBm.
	Green	 Flashing at 400-ms intervals	Communications processing ended normally with a reception level between -41 and -43 dBm.
	Green	 Flashing at 600-ms intervals	Communications processing ended normally with a reception level between -44 and -46 dBm.
	Green	 Flashing at 800-ms intervals	Communications processing ended normally with a reception level between -47 and -49 dBm.
	Green	 Flashing at 1,000-ms intervals	Communications processing ended normally with a reception level between -50 and -52 dBm.
	Green	 Flashing at 1,200-ms intervals	Communications processing ended normally with a reception level between -53 and -55 dBm.
	Green	 Flashing at 1,400-ms intervals	Communications processing ended normally with a reception level between -56 and -58 dBm.
	Green	 Flashing at 1,600-ms intervals	Communications processing ended normally with a reception level between -59 and -61 dBm.
	Green	 Flashing at 1,800-ms intervals	Communications processing ended normally with a reception level between -62 and -64 dBm.
	Yellow	 Flashing at 2,000-ms intervals	The RF Tag being communicated with has changed.
	White	 Lit	The RF Tag being communicated with has changed.
	Red	 Lit	Communications processing ended in an error.

 **Precautions for Correct Use**

- The custom settings for the operation indicators are not used for the reception level monitor.
- The indicators will light in the above green, yellow, and red colors for the reception level monitor regardless of whether communications diagnostics are enabled or disabled.
- The custom settings for the operation indicators are not used for the reception level monitor.

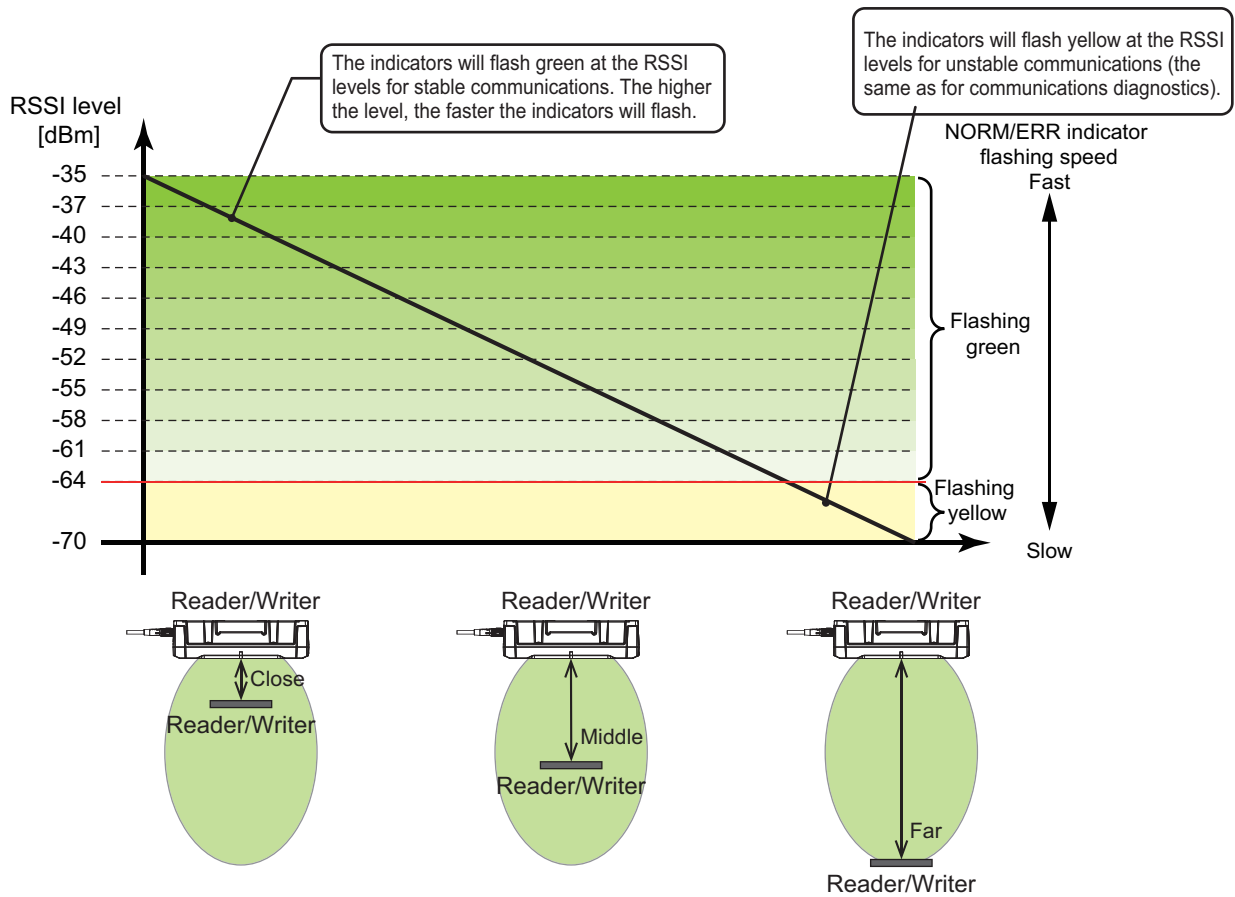

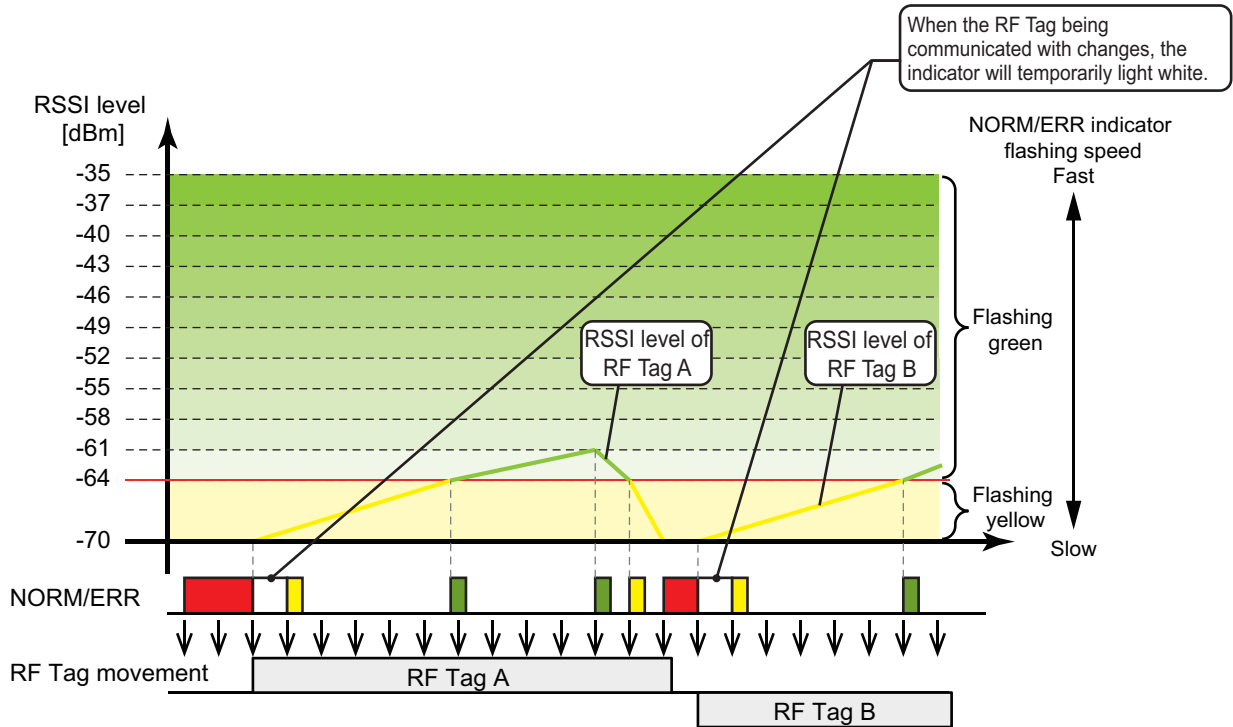

Measurement Method for Multiaccess Communications

To analyze communications with multiple RF Tags with the reception level monitor, select the *Multi* Option and then click the **Start** Button. When analysis begins, the Reader/Writer will start taking measurements for up to eight RF Tags and the reception level display for the RF Tags will be updated in realtime. To stop taking measurements, click the **Stop** Button.

● Reception Level Monitor View

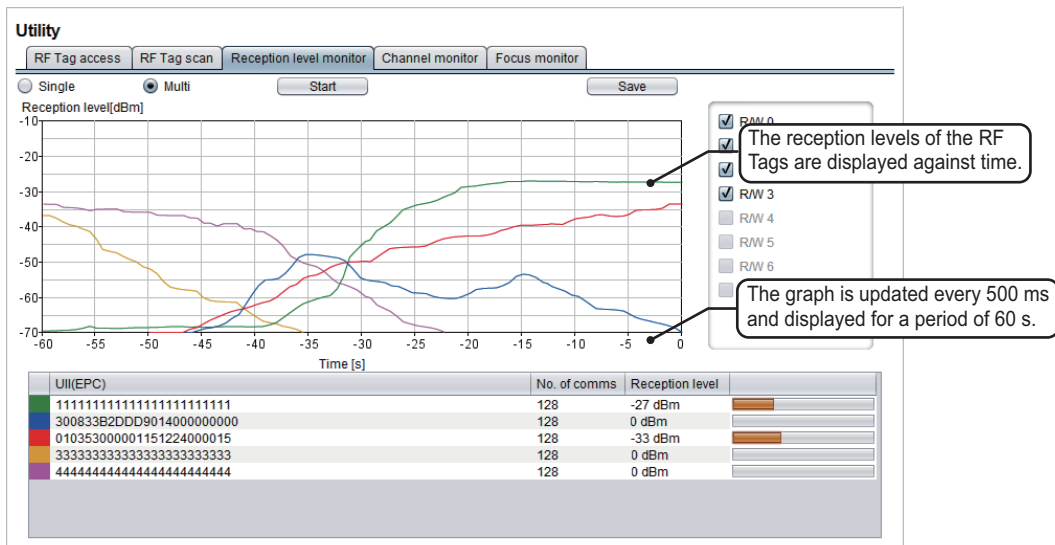



Precautions for Correct Use

- The RUN indicator will light cyan during the measurements.
 - During measurements, the NORM/ERR indicators will flash once in red or green according to the results of multiaccess communications.
 - During the measurements, the Reader/Writer will repeatedly communicate with the RF Tags to read the IDs with multiaccess communications.
 - The reception level graph is updated every 500 ms and displayed for a period of 60 s.
 - You can use the **Save** Button to download up to 360 measurements (500 ms x 360 measurements = 180 s, or 3 min).
 - If you close the Web browser interface or disconnect the communications cable during the measurements, the test operation status (i.e., the RUN indicator lit in cyan) may continue. If that occurs, cycle the power supply to the Reader/Writer to reset it.
-

6-9-4 Channel Monitor

Outline

The Reader/Writer can measure the noise level on each channel so that you can check the channels used by nearby Reader/Writers and check how much radio wave interference there is.

You can use this to identify and perform countermeasures for any equipment that are sources of noise in the application environment before you start operation or when troubles occur to achieve more stable RFID system operation.

Noise Level Measurement Method

The Channel Monitor View displays the measured noise levels of the channels on a bar graph. Click the **Start** Button to start measurements for the channel monitor. After measurements are started, the noise level will be measured for each channel and updated on the display in realtime. To stop taking measurements, click the **Stop** Button.

While monitoring the levels, the maximum noise level for each channel is displayed as the peak value.

The overall diagnostic result of channel monitoring is displayed as the status.

● Channel Monitor View

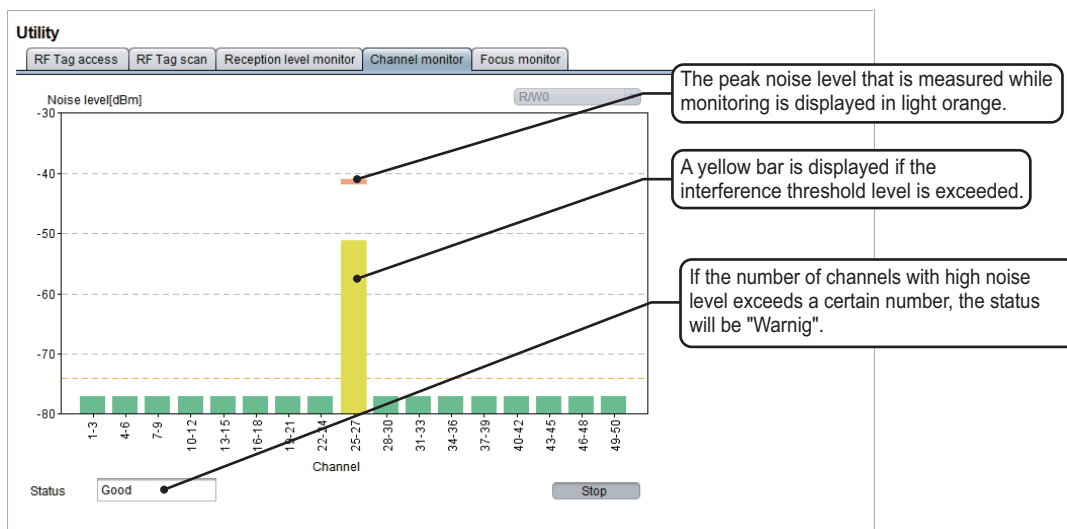

Precautions for Correct Use

- The RUN indicator will light cyan during the measurements.
- The NORM/ERR indicator will repeatedly flash green once during the measurements.
- The noise level of each channel is displayed with a bar graph. If the threshold of -74 dBm is exceeded, a yellow bar will be displayed. (The bar is green if the threshold has not been exceeded.)
- If you stop and restart monitoring, the peak noise levels will be reset.
- If the status is "Good," the ambient noise environment is good. If "Warning" is displayed, there is too much interference. The diagnostic criteria for the status depends on the model number.
- If you close the Web browser interface or disconnect the communications cable during the measurements, the test operation status (i.e., the RUN indicator lit in cyan) may continue. If that occurs, cycle the power supply to the Reader/Writer to reset it.

6-9-5 Focus Monitor

Outline

The Focus Mode of the Reader/Writer uses a target level index to determine the RF Tag that is positioned in front of the Reader/Writer.

When the Reader/Writer receives a command from the host device, it communicates with the RF Tag that has the highest target level. The target levels will change according to the positions and travel speeds of the RF Tags passing through the communications range. The distance between RF Tags also has some influence on the target levels of those RF Tags.

You can use a focus monitor to check and adjust differentiation of target RF Tags and achieve more stable RFID system operation.

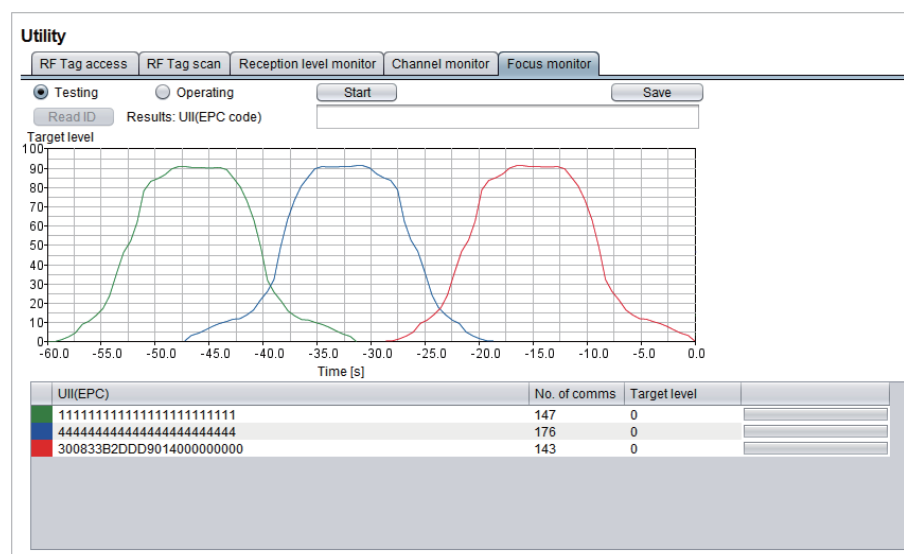

Precautions for Correct Use

- Focus Monitor is disabled when Multi-Reader/Writer Function is enabled.
For details, refer to “6-10-5 Maintenance functions during Multi-Reader/Writer use”.

Monitor Method during Operation

To check the target levels during operation, select the *Operating* Option on the Focus monitor View and click the **Start** Button. The Reader/Writer will start measuring the target levels of the RF Tags and update the target level display for up to eight RF Tags in realtime. To stop taking measurements, click the **Stop** Button.

● Focus Monitor View

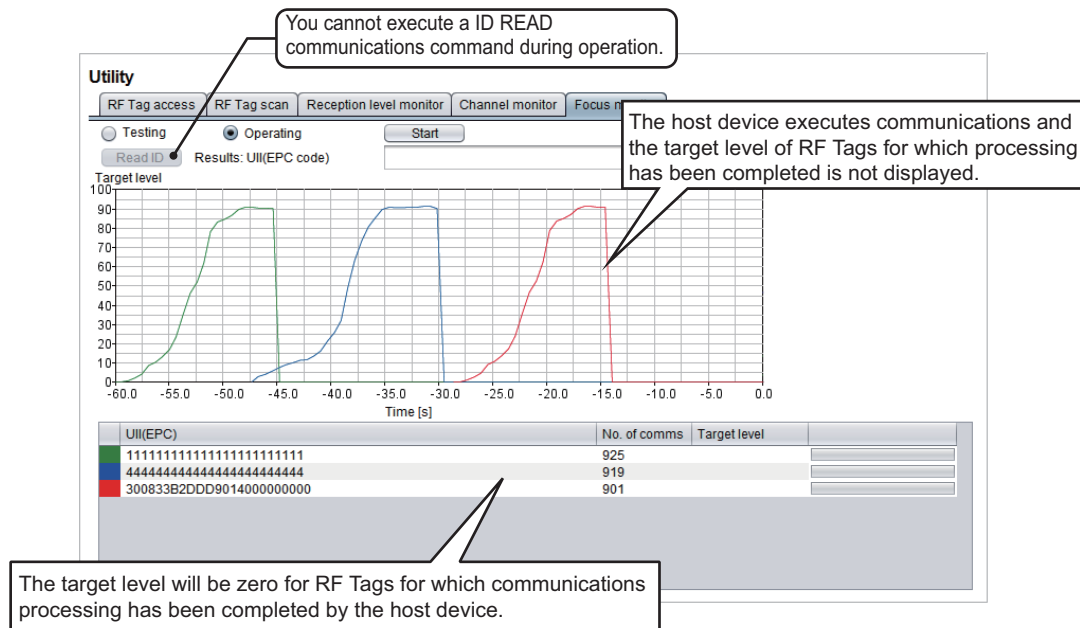

Precautions for Correct Use

- The RUN indicator will light cyan during operation.
- The target level graph is updated every 500 ms and displayed for a period of 60 s.
- You can use the **Save** Button to download up to 360 measurements (500 ms x 360 measurements = 180 s, or 3 min).

6-10 Multi-Reader/Writer Function

6-10-1 Outline

The Multi-Reader/Writer function allows connection to multiple Reader/Writers, and performs communications with RF Tags.

It can connect to a maximum of eight Reader/Writers, and performs master/slave control with one Reader/writer as the master, and the other Reader/Writers as slaves. Because multiple slave Reader/Writers can be jointly controlled simply by controlling a master Reader/Writer, it is possible to easily perform complicated controls from the host device.

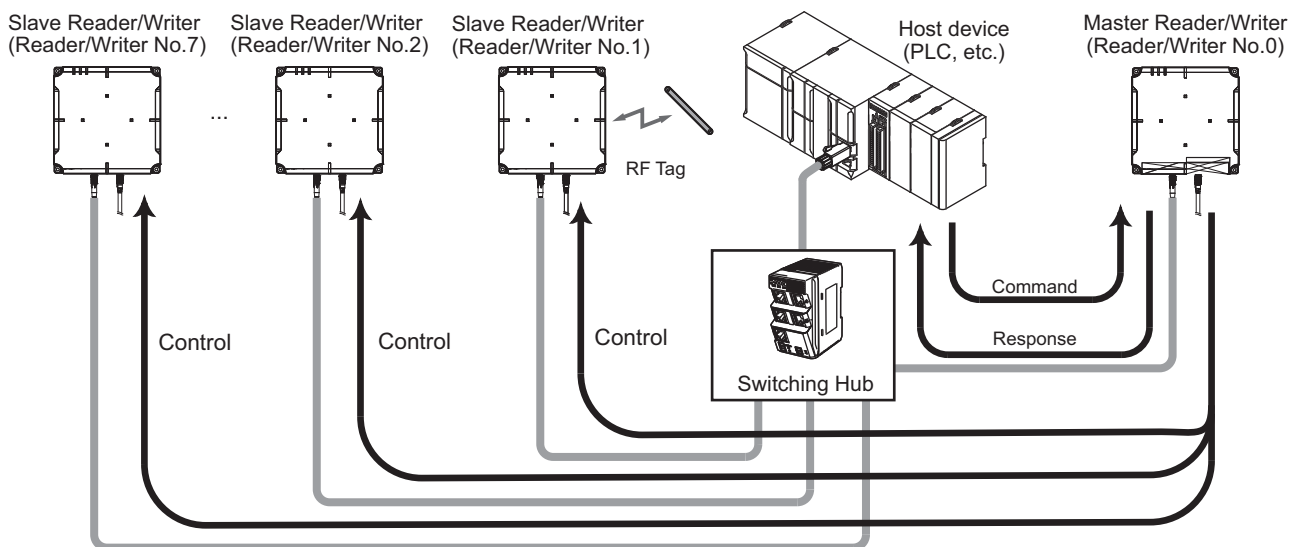

In the Multi-Reader/Writer function, the slave Reader/Writers connected to the master Reader/Writer are differentiated by the following Reader/Writer numbers.

Reader/Writer Type	Reader/Writer Number	Remarks
Master Reader/Writer	0	The Reader/Writer numbers are not used when the Multi-Reader/Writer function is disabled.
Slave Reader/Writer 1	1	
Slave Reader/Writer 2	2	The Reader/Writer numbers will be moved forward by the number of slave Reader/Writers. (Configuration with middle numbers missing is not possible)
Slave Reader/Writer 3	3	
Slave Reader/Writer 4	4	
Slave Reader/Writer 5	5	
Slave Reader/Writer 6	6	
Slave Reader/Writer 7	7	



Precautions for Correct Use

- When using this function, the Reader/Writers connected by the Multi-Reader/Writer function must all be Version 3.0 or later.
- When using this function, the Reader/Writers connected by the Multi-Reader/Writer function must all be the same model.
- The Slave Reader/Writer (V780-HMD68-ETN-□□-S) does not accept communications commands or Reader/Writer setting commands. * 1
Also, it does not accept connection from other than the Master Reader/Writer. * 2
- *1. When using a standard Reader/Writer (V780-HMD68-EIP-□□) as a slave Reader/Writer, the Getting command will be accepted.
- *2. Connection from the web port will be accepted.
- The slave reader/writer (V780-HMD68-ETN-□□-S) can not be used as a master reader/writer.

6-10-2 Multi-Reader/Writer Modes

The processing operations for communications of multiple linked Reader/Writers differs depending on the Multi-Reader/Writer mode specified in the Reader/Writer.

The setting of the Multi-Reader/Writer mode is effective following restart. It is saved in internal memory in the Reader/Writer even after the power supply is turned OFF.

Name	Description	Remarks
Field Extension Mode	This virtually extends the communications range with multiple Reader/Writers, and communicated with RF Tags detected by any of the Reader/Writers.	

Combination of Communications Modes

Name	Once	Auto	Focus	Repeat
Field Extension Mode	Supported	Supported	Not supported	Supported

Combination of Communications Commands

Command name	Field Extension Mode
ID READ	Supported
ID WRITE	Supported
DATA READ	Supported
DATA WRITE	Supported
LOCK	Supported
DATA FILL	Supported
MULTIACCESS ID READ	Supported
MULTIACCESS DATA READ	Supported

Supported: Available, Not supported: Unavailable



Precautions for Correct Use

- When starting up with an unavailable Multi-Reader/Writer mode and communications mode combination, the master Reader/Writer will detect the minor fault "Multi-Reader/Writer Cannot Start."

Field Extension Mode

This virtually extends the communications range with multiple Reader/Writers, and communicated with RF Tags detected by any of the Reader/Writers.

Use RF Tag communications in the following applications.

- Once multiple RF Tags passing through in logistics/transport, etc., have been read, RF Tag communications are possible at high reading accuracy by arranging multiple Reader/Writers and creating a wide communications range.

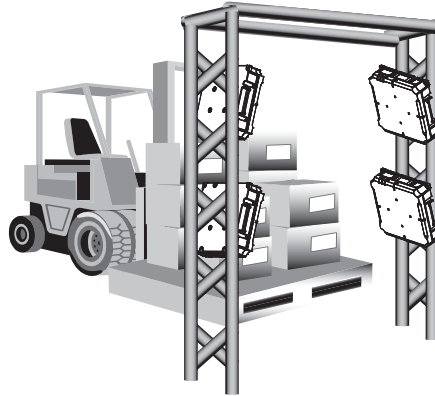

- If a point where the RF Tags are unreadable (null point) is generated due to the cancellation (multi-path) of the radio waves due to reflected wave in the ambient environment, RF Tag communications will be possible at high reading accuracy if multiple Reader/Writers are arranged, supplementing the null point.

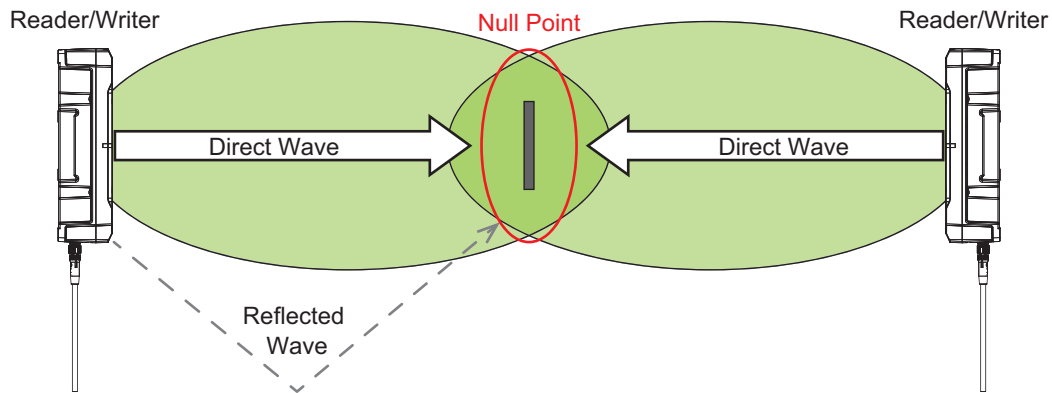

● Operation of "Once" Communications Mode

- If the RF Tag completes normally in any of the Reader/Writers in single-access

The master Reader/Writer communicates with the RF Tags by switching control of itself and the Slave Reader/Writers in time division. When "RF Tag Missing Error" or "RF Tag Communications Error" are detected in the communications processing of the Reader/Writers, the communications processing continues through switching the control in the order of Master → Slave 1 → Slave 2 → Slave 3, and repeats this until timeout. When an RF Tag is detected and completes normally, it returns the communications results without waiting for a timeout.

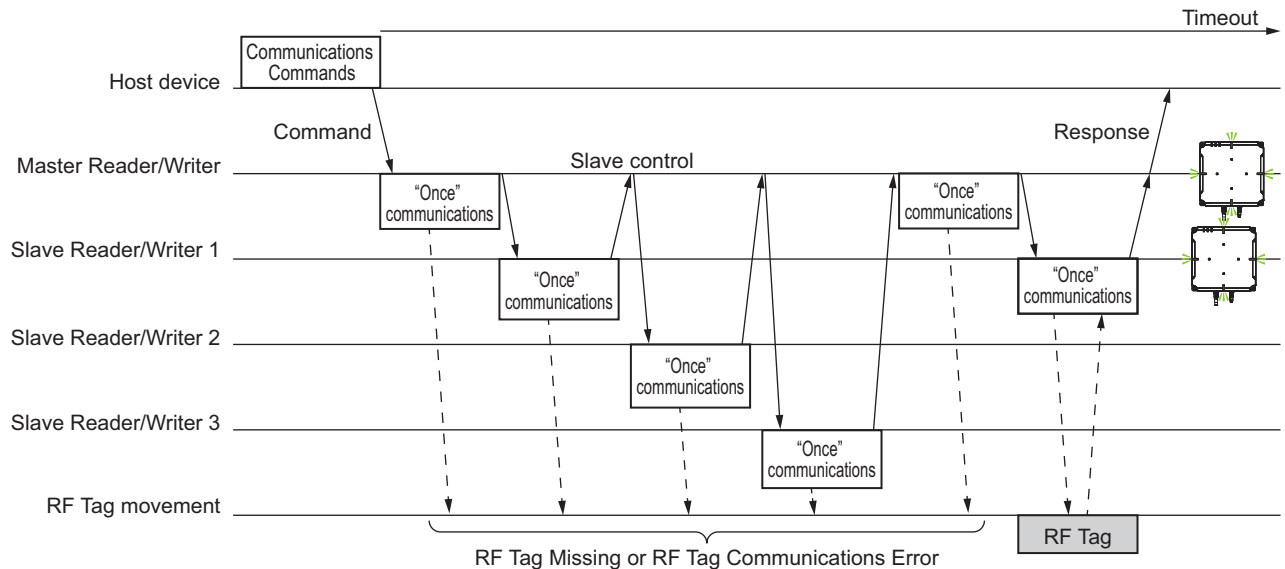

- If communications with an RF Tag completes abnormally in any of the Reader/Writers in single-access

The master Reader/Writer communicates with the RF Tags by switching control of itself and the Slave Reader/Writers in time division. When an RF Tag is detected and completes abnormally (other than the "RF Tag Missing Error" and "RF Tag Communications Error"), it returns the communications results without waiting for a timeout.

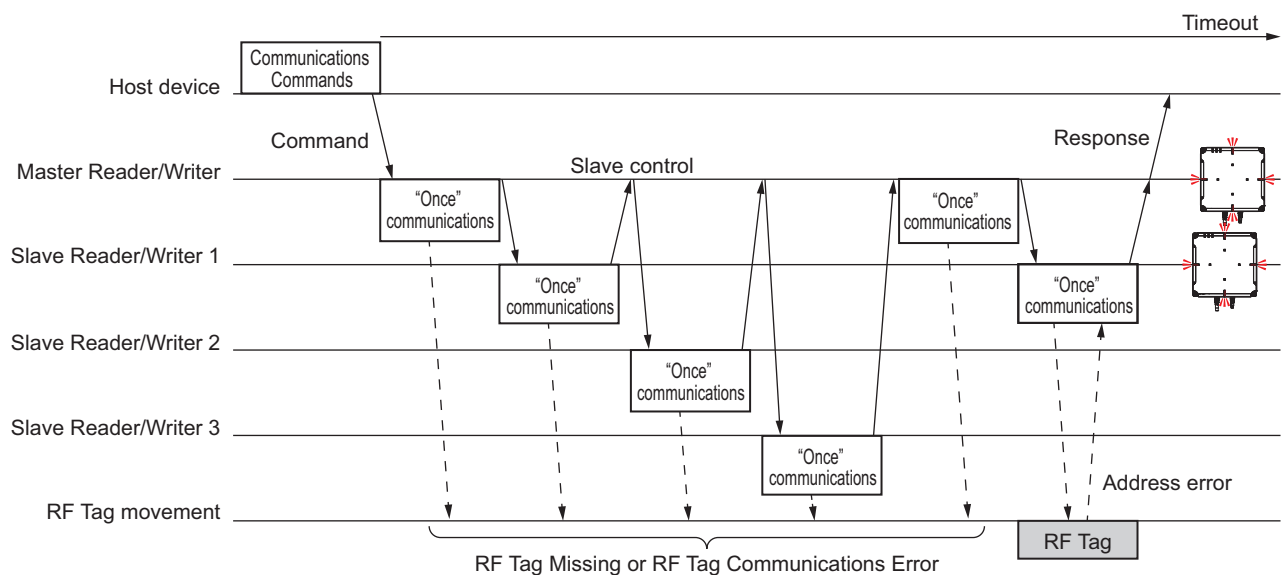



Precautions for Correct Use

- While Multi-Reader/Writer communications processing is continuing, the NORM/ERR indicators will not light red even if "RF Tag Missing Error" or "RF Tag Communications Error" is detected in a Reader/Writer.
- The NORM/ERR indicator lamp of the Reader/Writer will light green/red after normal completion/error completion in Multi-Reader/Writer communications processing. Finally, the NORM/ERR indicators of the master Reader/Writer will light green/red when replying to the host device.

- If multiple RF Tags are detected by any of the Reader/Writers in multiaccess

The master Reader/Writer communicates with the RF Tags by switching control of itself and the Slave Reader/Writers in time division. While detecting multiple RF Tags within the timeout time, communications processing will repeat by switching in the sequence of Master → Slave 1 → Slave 2 → Slave 3, and the communications result will be returned when RF Tag communications are completed.

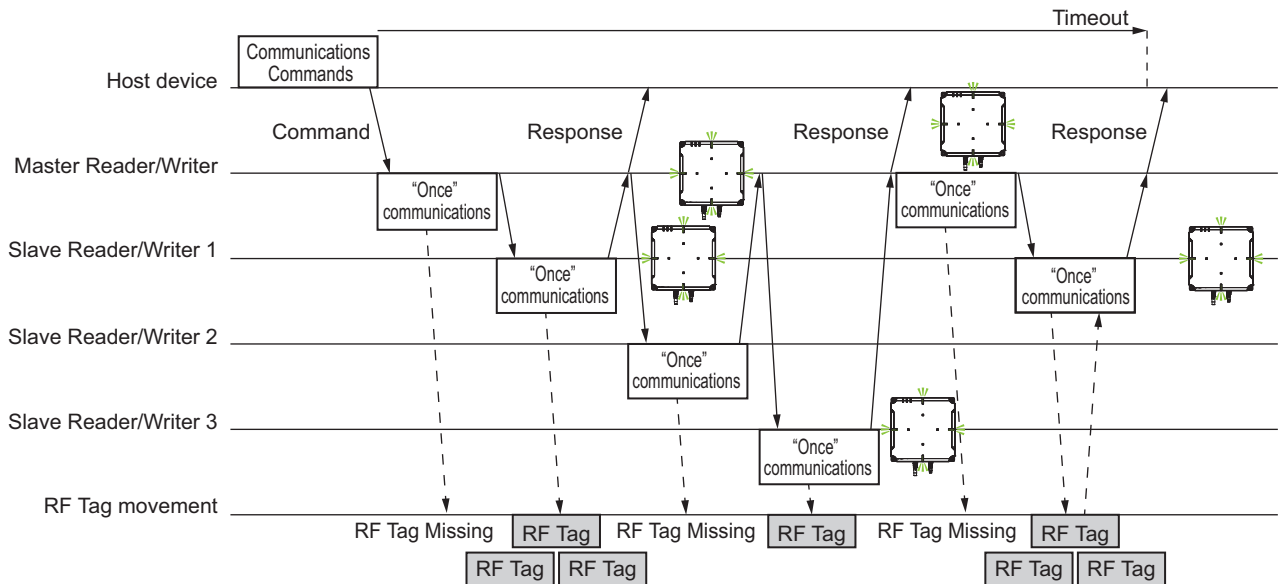

- If no RF Tags exist in any of the Reader/Writers in single-access/multiaccess

When the master Reader/Writer cannot complete communications within the timeout time, the communications results ("RF Tag Missing Error" or "RF Tag Communications Error") will be returned after timeout. If a duplicate "RF Tag Communications Error" is detected in the same RF Tag, the first Reader/Writer detected will be returned.

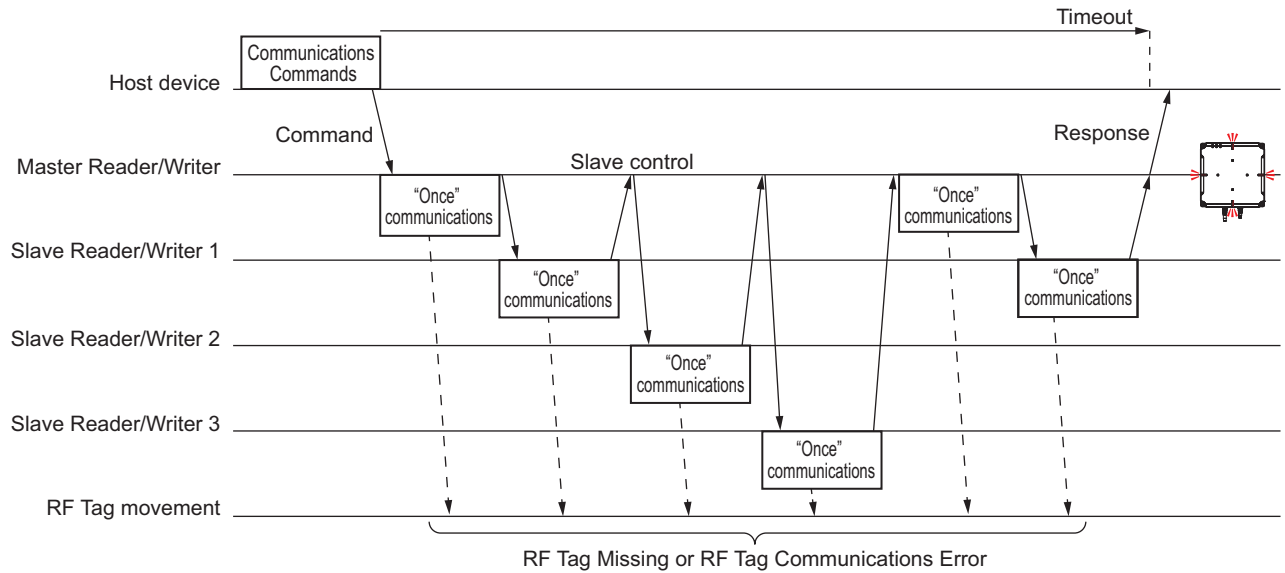

● Operation of the "Auto" Communications Mode

- If the RF Tag completes normally in any of the Reader/Writers in single-access

The master Reader/Writer switches the control of itself and the Slave Reader/Writers in time division, waits for the entrance of the RF Tags into any of the communications range, and will return the communications result after detection.

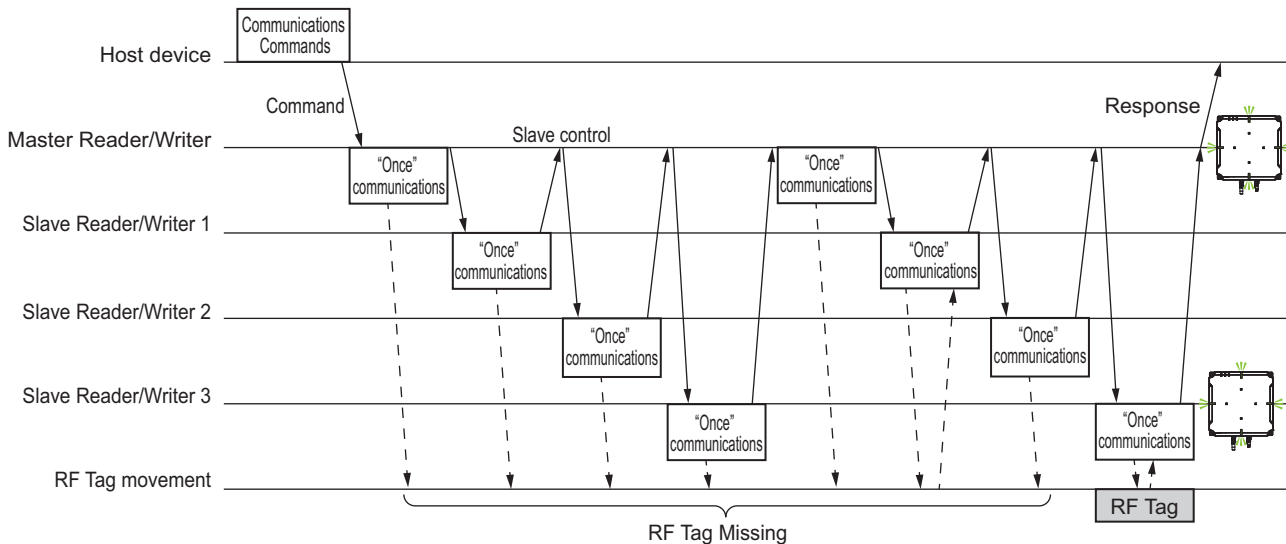

- If the RF Tag completes normally in any of the Reader/Writers in multiaccess

The master Reader/Writer switches the control of itself and the Reader/Writers in time division, waits for the entrance of the RF Tags into any of the communications range, and communications will start if even one RF Tag is detected. Thereafter, multiple RF Tags are detected within the period from the start of communications until a timeout, and the communications results are returned when RF Tag communications are completed.

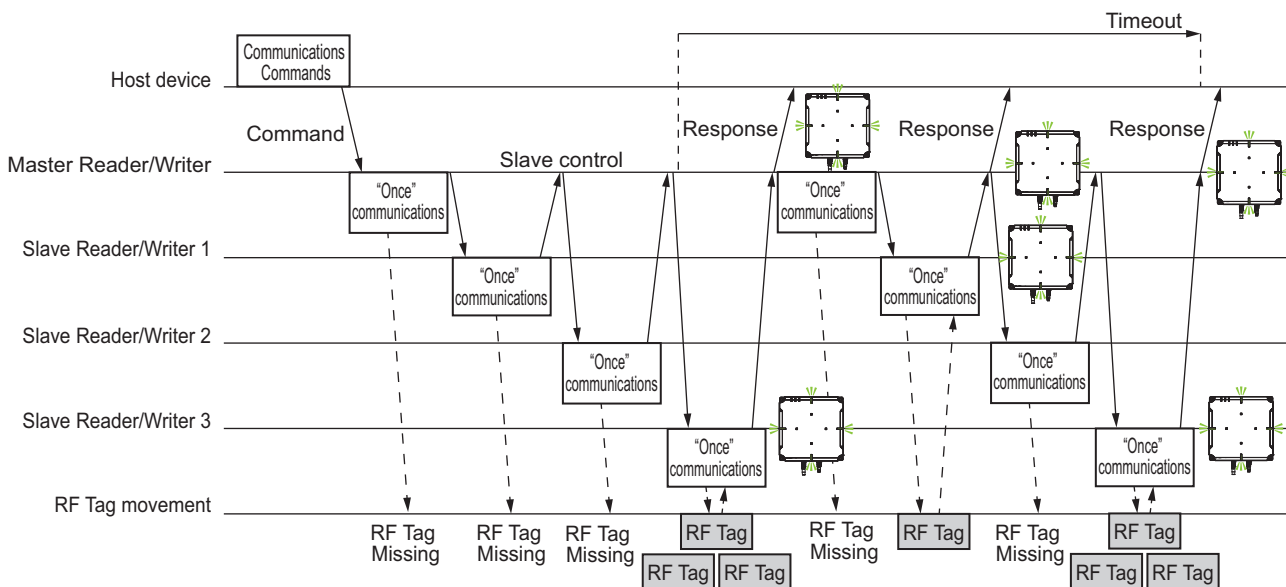

● Operation of the “Repeat” Communications Mode

- If the RF Tag completes normally in any of the Readers/Writers in single access

The Master Reader/Writer switches the control of itself and the Slave Readers/Writers in time division, waits for the entrance of the RF Tags into any of the communications range, and immediately returns the communications results upon detection.

The communications process continues until the command execution request from the host device is cleared.

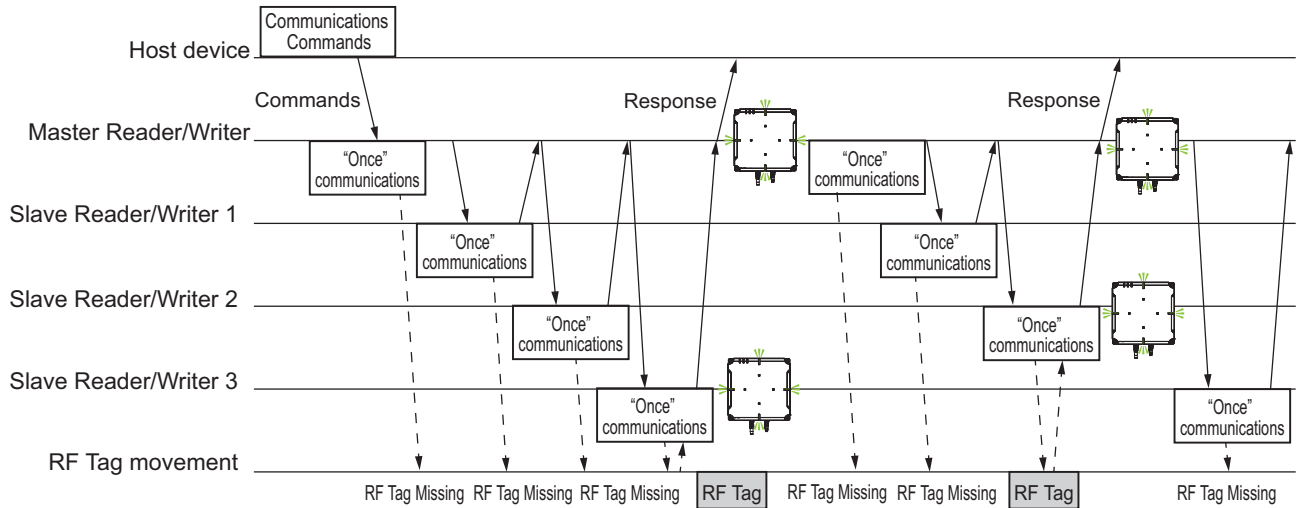

6-10 Multi-Reader/Writer Function

6

- If the RF Tag completes normally in any of the Reader/Writers in multiaccess

The Master Reader/Writer switches the control of itself and the Slave Readers/Writers in time division, waits for the entrance of the RF Tags into any of the communications range, and starts communications even if one RF Tag is detected. The Master Reader/Writer returns the communications results when RF Tag communications are completed.

The communications process continues until the command execution request from the host device is cleared.

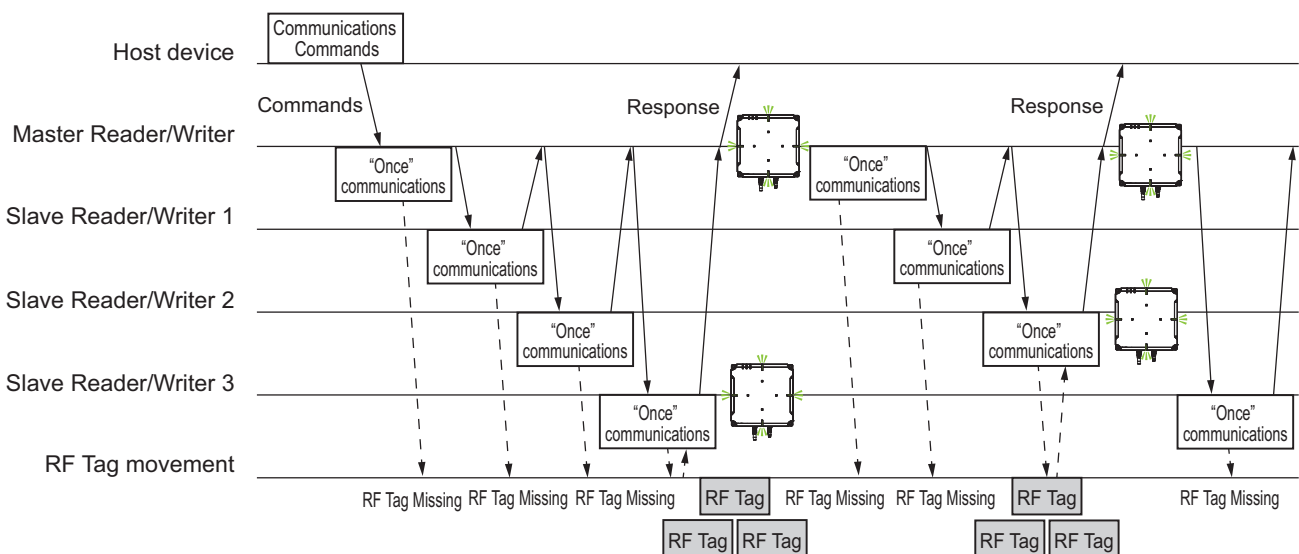

6-10-2 Multi-Reader/Writer Modes

6-10-3 Application

Use this function according to the usage procedure example of the Multi-Reader/Writer mode.

Here, we give an example of the installation of four Reader/Writers as shown in the figure below.

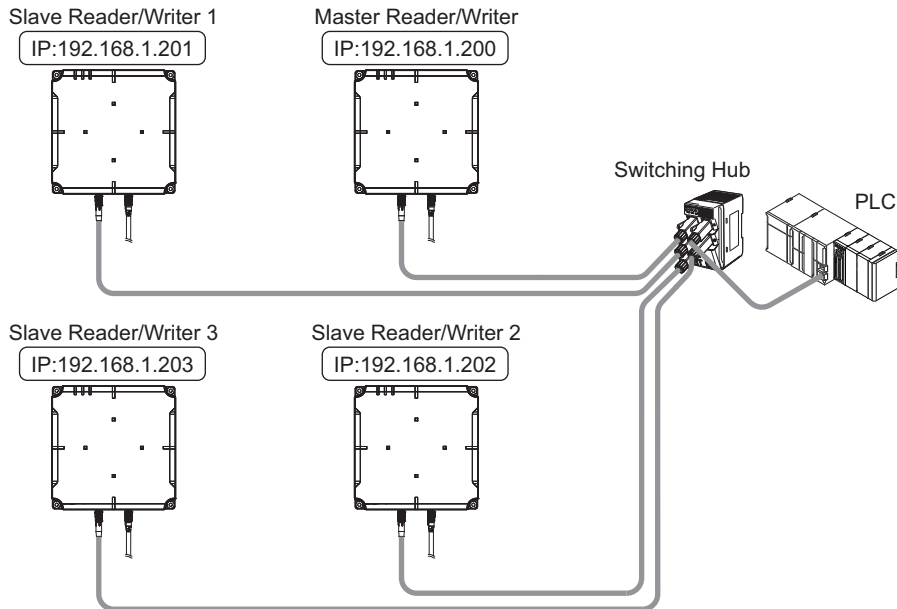

Precautions for Correct Use

Communication range extension mode can not be used only with the slave reader / writer (V780-HMD68-ETN-□□-S).

Be sure to use at least one master reader / writer (V780-HMD68-ETN-□□).

Enable the Field Extension Mode

- 1 Set the same network IP address in all of the Reader/Writers. Connect the Ethernet cable, and start up.
- 2 Start up the web browser on the PC, and specify the IP address of the master Reader/Writer.
- 3 Click the **Device Settings** Button and then click the **Multi-Reader/Writer setting** Tab, Multi-Reader/Writer setting tab page will be displayed.

The screenshot shows the 'Device settings' web interface. At the top, there are two tabs: 'LED custom settings' and 'Multi Reader/Writer setting'. The 'Multi Reader/Writer setting' tab is active. Below the tabs, there is a section for 'Multi Reader/Writer mode' with radio buttons for 'Disable' and 'Enable' (selected), and a dropdown menu for 'Field extension mode'. Below this is a table with columns for 'IP address', 'Status', 'Tx power(Read)', and 'Tx power(Write)'. The table lists seven 'Slave Reader/Writer' units. The first three units have IP addresses 192.168.1.201, 192.168.1.202, and 192.168.1.203. The fourth unit has IP address 0.0.0.0. The remaining three units have empty IP address fields. All units have a status of 'Not registered'. The Tx power for Read and Write is set to 27 dBm(15~27) for all units. At the bottom of the table, there are 'Update' and 'Set' buttons.

	IP address	Status	Tx power(Read)		Tx power(Write)	
Slave Reader/Writer1	192.168.1.201	Not registered	27	dBm(15~27)	27	dBm(15~27)
Slave Reader/Writer2	192.168.1.202	Not registered	27	dBm(15~27)	27	dBm(15~27)
Slave Reader/Writer3	192.168.1.203	Not registered	27	dBm(15~27)	27	dBm(15~27)
Slave Reader/Writer4	0.0.0.0	Not registered	27	dBm(15~27)	27	dBm(15~27)
Slave Reader/Writer5		Not registered	27	dBm(15~27)	27	dBm(15~27)
Slave Reader/Writer6		Not registered	27	dBm(15~27)	27	dBm(15~27)
Slave Reader/Writer7		Not registered	27	dBm(15~27)	27	dBm(15~27)

- 4 Place a check mark to enable the Multi-Reader/Writer mode. Then, specify the IP addresses for the slave Reader/Writers (3 units), and press the **Set** Button. This will restart the master Reader/Writer.
- 5 When the master Reader/Writer has restarted, it will perform connection processing with each of the registered slave Reader/Writers. The RUN indicator will change to yellow, which connected as slave Reader/Writers.

- 6** The master Reader/Writer will establish communications with all of the slave Reader/Writers, completing connection processing. You can check the Status of Multi-Reader/Writer setting view that completed connection.

Device settings

LED custom settings Multi Reader/Writer setting

Multi Reader/Writer mode Disable Enable Field extension mode

	IP address	Status	Tx power(Read)		Tx power(Write)	
Slave Reader/Writer1	192.168.1.201	Connected	27	dBm(15~27)	27	dBm(15~27)
Slave Reader/Writer2	192.168.1.202	Communication failure	27	dBm(15~27)	27	dBm(15~27)
Slave Reader/Writer3	192.168.1.203	Connected	27	dBm(15~27)	27	dBm(15~27)
Slave Reader/Writer4	0.0.0.0	Not registered	27	dBm(15~27)	27	dBm(15~27)
Slave Reader/Writer5		Not registered	27	dBm(15~27)	27	dBm(15~27)
Slave Reader/Writer6		Not registered	27	dBm(15~27)	27	dBm(15~27)
Slave Reader/Writer7		Not registered	27	dBm(15~27)	27	dBm(15~27)

Update Set

- 7** After this, the multiple Reader/Writers shall jointly operate by the issuing of communications commands from the host device to the master Reader/Writer.



Precautions for Correct Use

- The Multi-Reader/Writers shall repeat connection processing if communications are not established with the registered slave Reader/Writers, and connection processing is not completed (IP address specification error, Reader/Writer non-startup, etc.). The NORM/ERR indicator will light red at a specific interval until connection processing is completed.

Executing DATA READ Using the Field Extension Mode

- If the "RF Tag Communications Option" of the master Reader/Writer is "Once"

1 This will issue a DATA READ command from the host device to the master Reader/Writer.

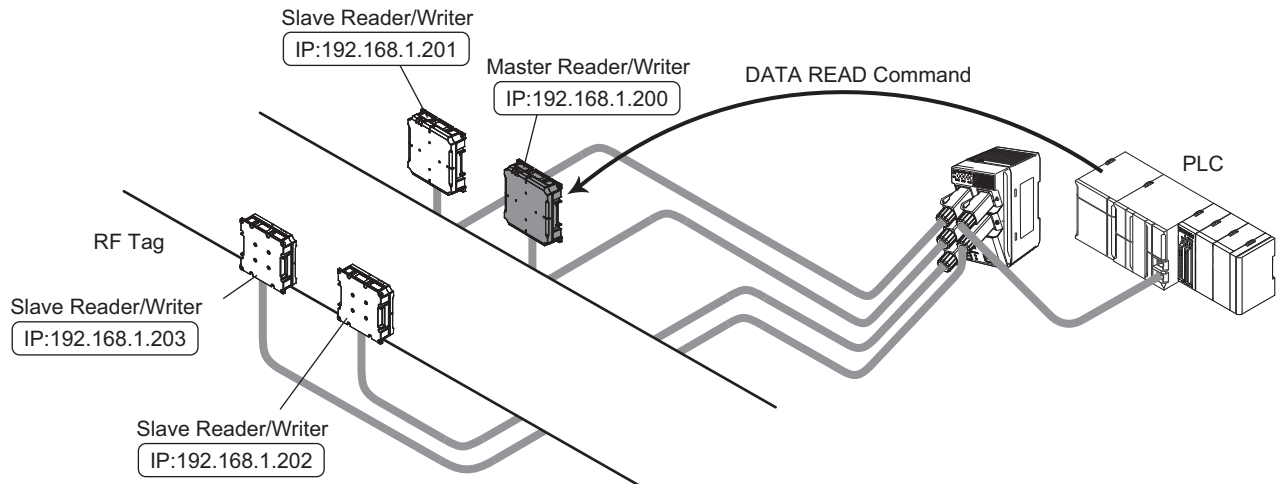

2 The master Reader/Writer will communicate with the RF Tags with the "Once" communications option. Here, if the communications have ended normally, or if the communications have ended with an error, a response is returned to the host device, and the processing ends. If an RF Tag Missing error or a communications error is detected, it will progress to step 3.

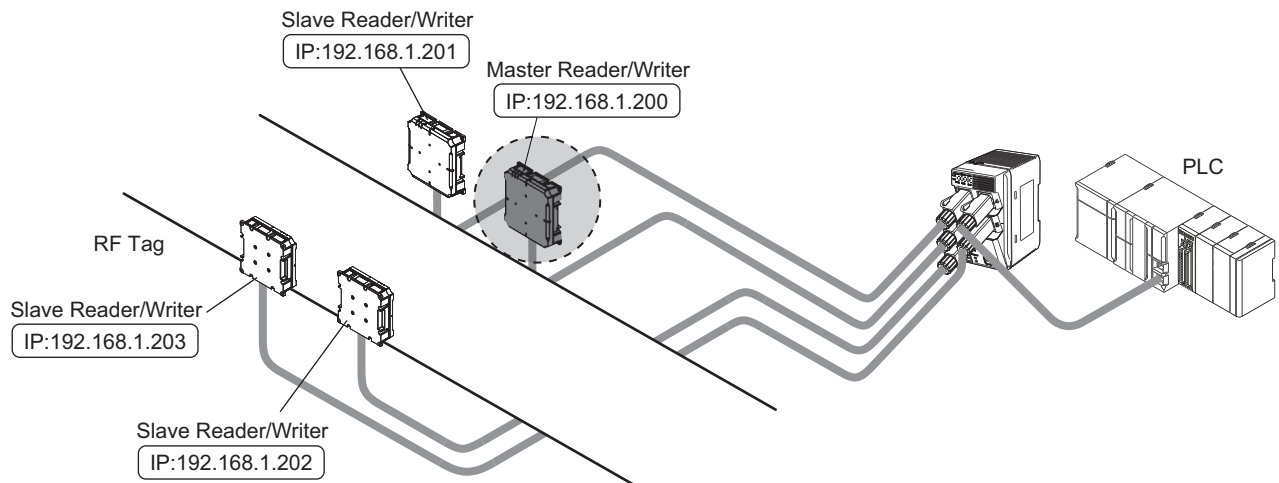

- 3** Slave No. 1 will communicate with the RF Tags with the "Once" communications option. Here, if the communications have ended normally, or if the communications have ended with an error, a response is returned to the host device, and the processing ends. If an RF Tag Missing error or an RF Tag communications error is detected, the processing will continue in the order of Slave No. 2, Slave No. 3.

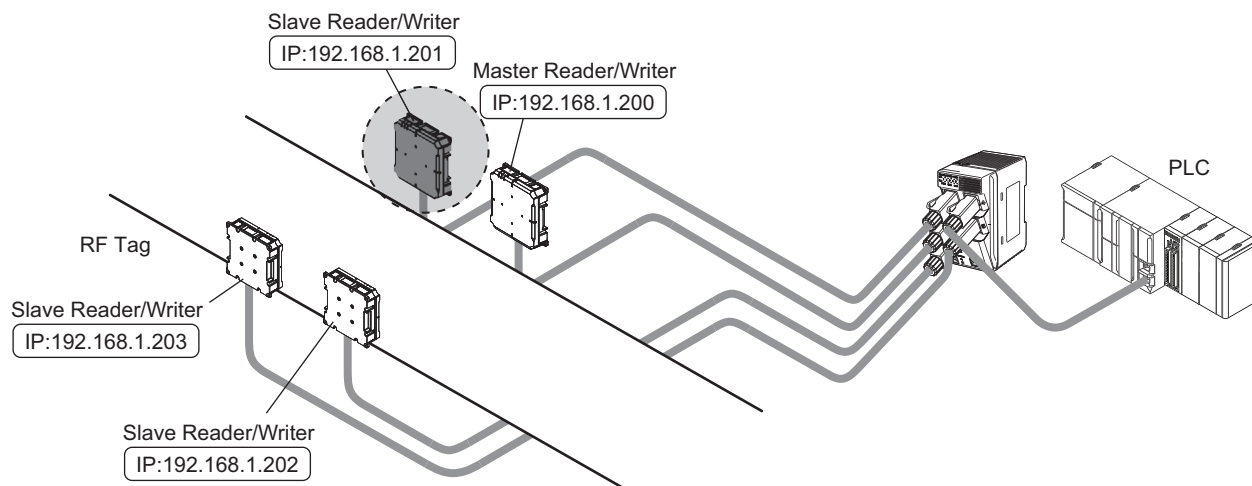

- 4** After the communications process of the Slave Reader/Writer comes a full circle, the operation is repeated from step 2. If the timeout time elapses during the communications process, a response (RF Tag Missing error or RF Tag communications error) is returned to the host device, and the processing ends.

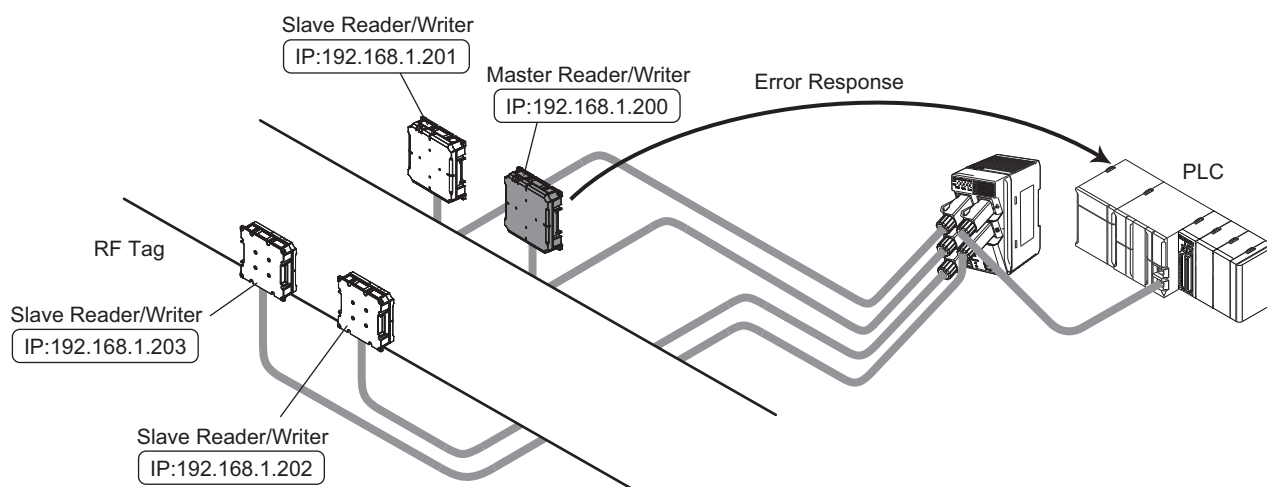

● If the "RF Tag Communications Option" of the master Reader/Writer is "Auto"

1 This will issue a DATA READ Command from the host device to the master Reader/Writer.

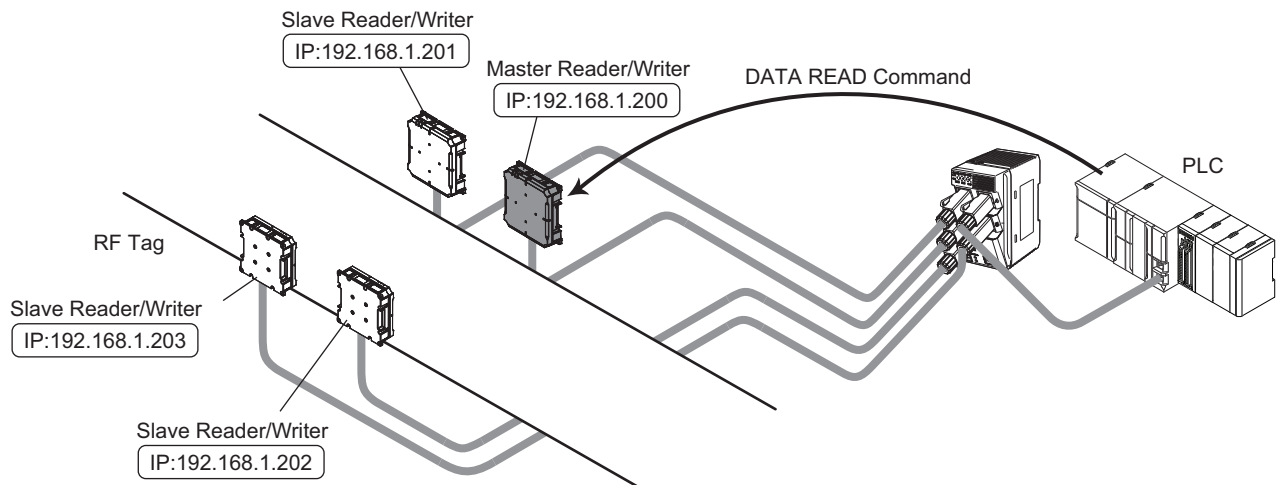

2 The master Reader/Writer will communicate with the RF Tags with the "Once" communications option. Here, if the communications have ended normally, or if the communications have ended with an error, a response is returned to the host device, and the processing ends. If an RF Tag Missing error or a communications error is detected, it will progress to step 3.

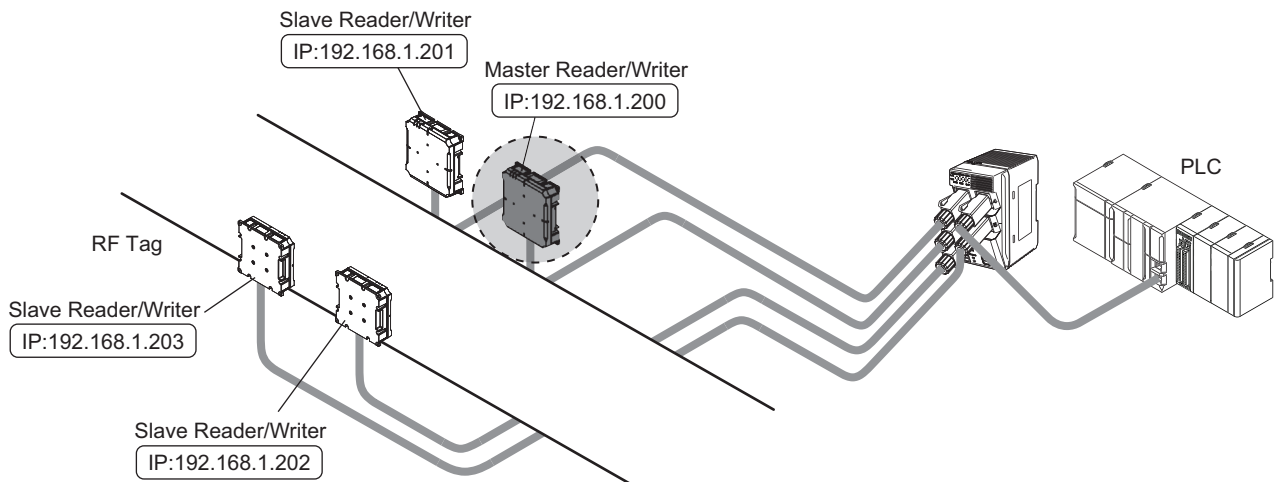

- 3** Slave No. 1 will communicate with the RF Tags with the "Once" communications option. Here, if the communications have ended normally, or if the communications have ended with an error, a response is returned to the host device, and the processing ends. If an RF Tag Missing error or a communications error is detected, the processing will continue in the order of Slave No. 2, Slave No. 3.

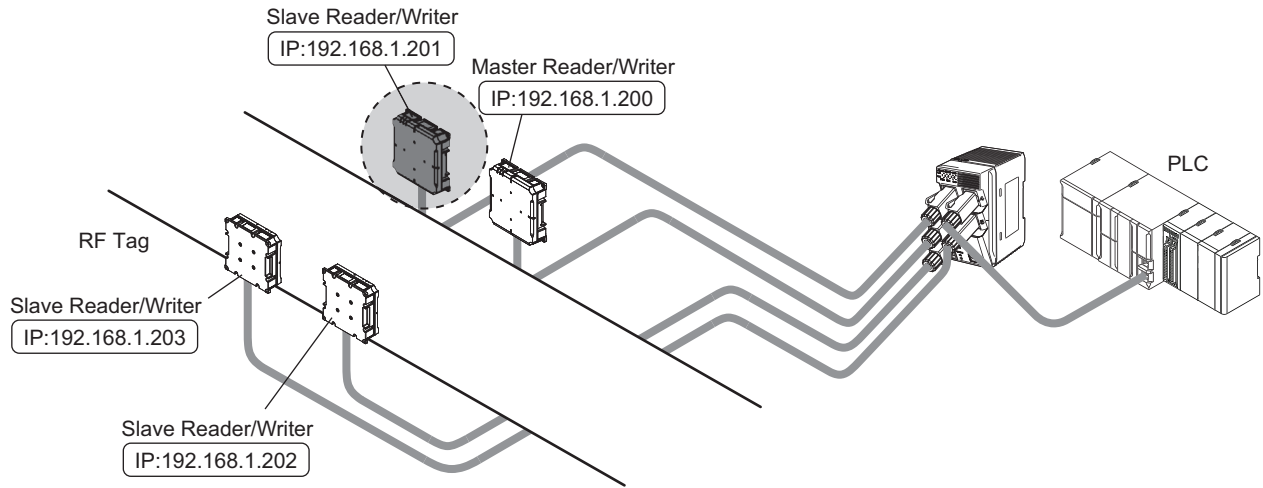

- 4** After the slave Reader/Writer communications processing has completed one cycle, operation will repeat from Procedure 2.

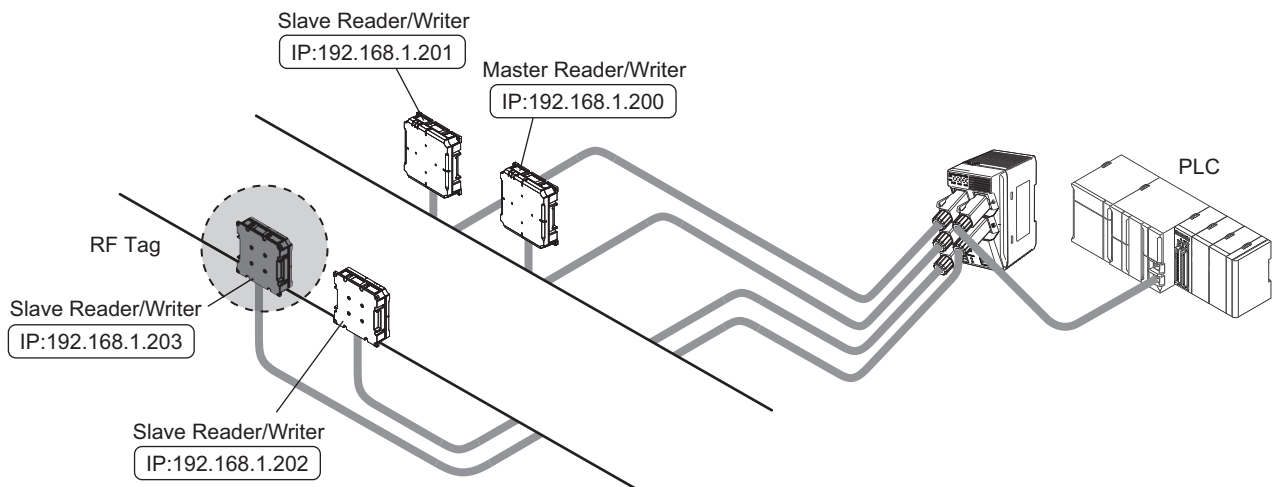

Precautions for Correct Use

- The respective Reader/Writers will not perform simultaneous communications operations in the Field Extension Mode. The respective Reader/Writers will perform communications operations with time division.

● If the “RF Tag Communications Option” of the master Reader/Writer is “Repeat”

- 1** This will issue a DATA READ command from the host device to the master Reader/Writer.

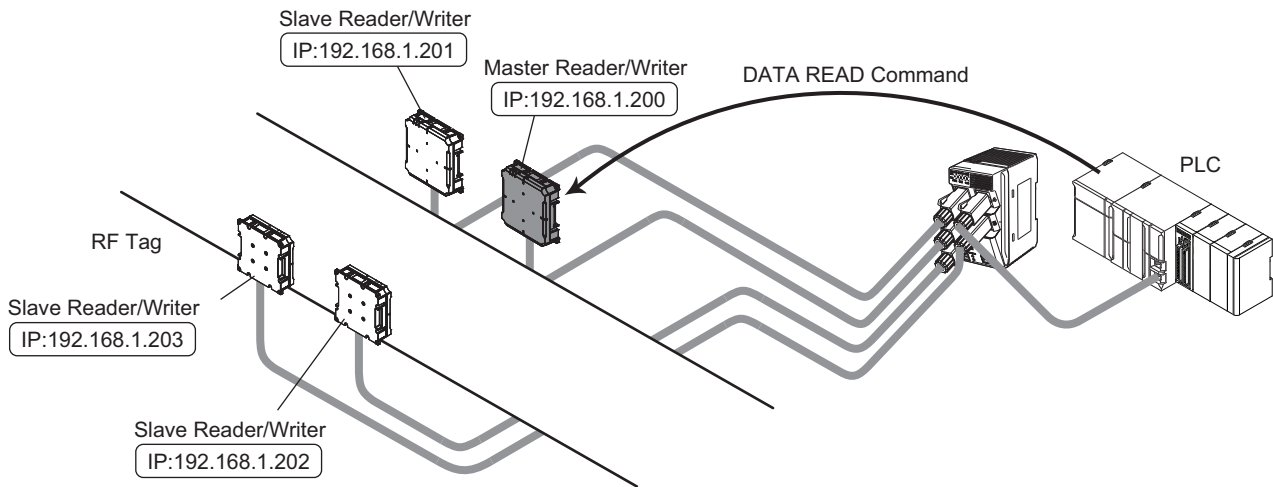

- 2** The master Reader/Writer will communicate with the RF Tags through the “Once” communications option. Here, if the communications have ended normally, the communications results are returned to the host device. If the communications results indicate an RF Tag missing error or a communications failure, an error response is not returned to the host device, but if any other error is detected, the error results are returned to the host device. The communications processing will then progress to step 3.

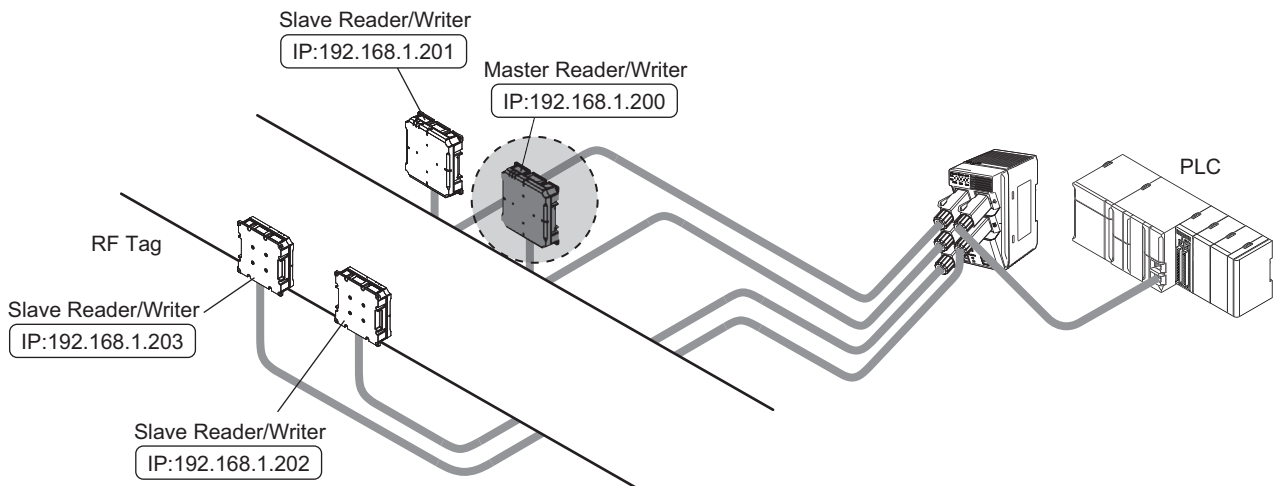

- 3** Slave No. 1 will communicate with the RF Tags through the “Once” communications option. Here, if the communications have ended normally, the communications results are returned to the host device. If the communications results indicate an RF Tag missing error or a communications error, an error response is not returned to the host device, but if any other error is detected, the error results are returned to the host device. The processing will continue in the order of Slave No. 2, Slave No. 3.

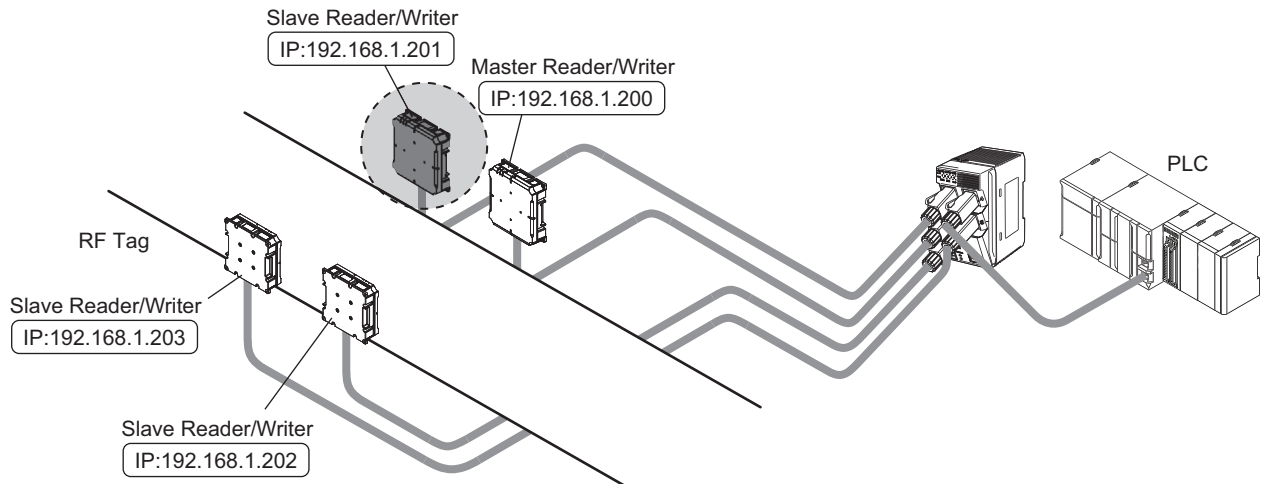

- 4** After the communications process of the Slave Reader/Writer comes full circle, the operation will be repeated from step 2.

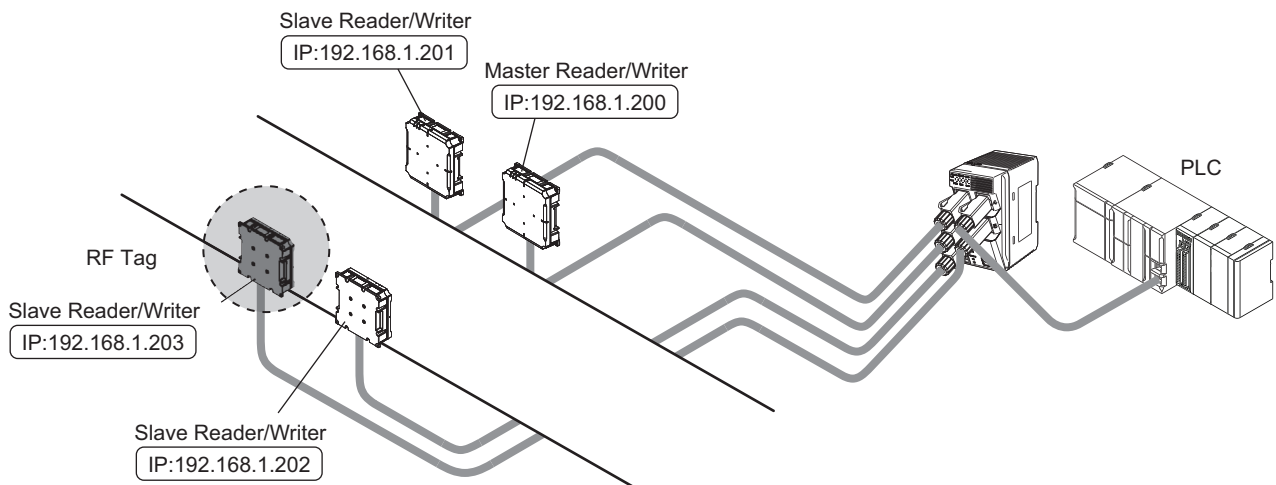

Precautions for Correct Use

- The respective Readers/Writers will not perform simultaneous communications operations in the Field Extension Mode. The respective Readers/Writers will perform communications operations with time division.

6-10-4 Communications conditions during Multi-Reader/Writer use

While the Multi-Reader/Writer is enabled, the master Reader/Writer communications conditions can be set for each individual slave Reader/Writer or globally set for all Reader/Writers. The various setting items are as follows:

Setting classification	Setting item	Description	Remarks
SET TAG COMMUNICATIONS CONDITIONS (Basic)	Communications mode	Global	
	Communications speed	Global	
	Communications timeout time	Global	The "RF Communications Timeout Time" setting of the master Reader/Writer is the timeout time relative to the total communications processing in conjunction with multiple Reader/Writers.
	Write verify	Global	
	RF communication diagnostics	Global	The diagnostics function is disabled.
SET TAG COMMUNICATIONS CONDITIONS (Advanced)	Transmission power	Individual	The transmission power of the slaves is maintained by the master Reader/Writer.
	Channel	Global	
	Gen2 Session	Global	
	Access password	Global	
	Transmission time	Global	
	RSSI filter	Individual	Set individually in each Reader/Writer before enabling Multi-Reader/Writer.
	RF Tag select filter	Global	
Smoothing buffer	Global		

6-10-5 Maintenance functions during Multi-Reader/Writer use

With the Multi-Reader/Writer function enabled, the various maintenance functions available in the Web browser interface will operate as follows:

View classification	Tab page classification	Description	Remarks
Tuning	Transmission Power Tuning	It is possible to tune the transmission power for each Reader/Writer on the Multi-Reader/Writer configuration.	
Utilities	RF Tag Access	It is possible to confirm communications command/response communications when multiple Reader/Writers have performed joint operation.	Implementation in Single-access Communications
	RF Tag Scanning	It is possible to confirm the presence of peripheral RF Tags when multiple Reader/Writers perform joint operation.	Implementation in Multiaccess Communications
	Reception level monitor	It is possible to confirm the reception level for each Reader/Writer on the Multi-Reader/Writer configuration.	
	Channel Monitor	It is possible to confirm the channel usage state of peripheral devices for each Reader/Writer on the Multi-Reader/Writer configuration.	
	Focus Monitor	Button operation is disabled.	The Multi-Reader/Writer functions and Focus functions cannot be used together.
Logs	Command error log	This displays the command errors during joint operation of multiple Reader/Writers.	
	System error log	This displays just the system errors of the master Reader/Writer.	Reference the system errors of the slave Reader/Writers via the direct Web browser interface and commands.
	RF Communications Diagnostics Log	Communications diagnostic information is not displayed during joint operation of multiple Reader/Writers.	The Multi-Reader/Writer functions and Communications Diagnostics functions cannot be used together.

Transmission Power Tuning for Multiple Reader/Writers

You can use the Transmission Power Tuning View (click the **Device Settings** Button and then click the **Multi-Reader/Writer setting** Tab) on the Web browser interface, to adjust the transmission power settings separately for the master or slave Reader/Writer.

You can specify the target Reader/Writer number to adjust on the Transmission Power Tuning Tab Page.

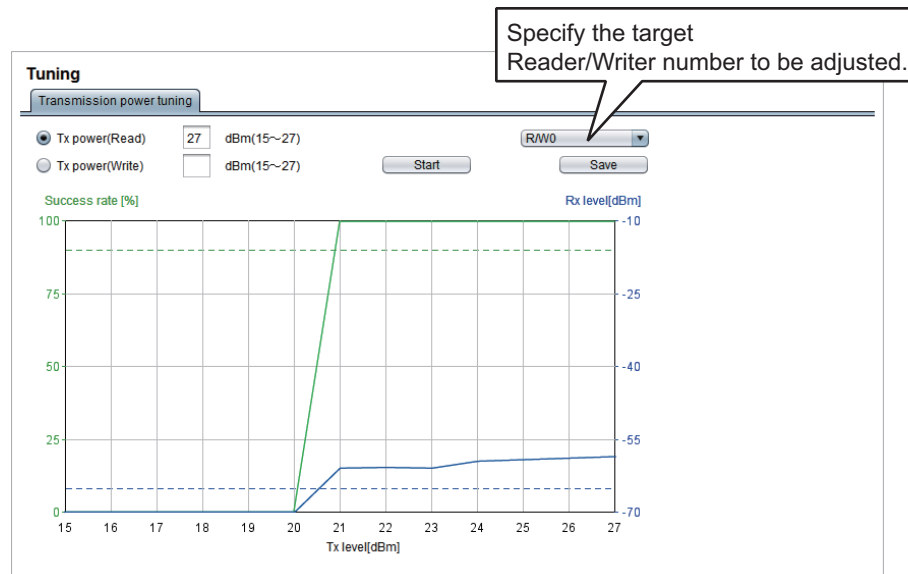

Reception level monitor for Multiple Reader/Writers

You can use the Utilities View (click the **Utilities** Button and then click the **Reception level monitor** Tab) on the Web browser interface, to check the reception level separately for the master or slave Reader/Writer.

● Single-access

On the Reception Level Monitor Tab Page, specify the Reader/Writer numbers to be measured in the Reader/Writers on the Multi-Reader/Writer configuration.

Click the **Start** Button after specification will start measurement by the subject Reader/Writers.

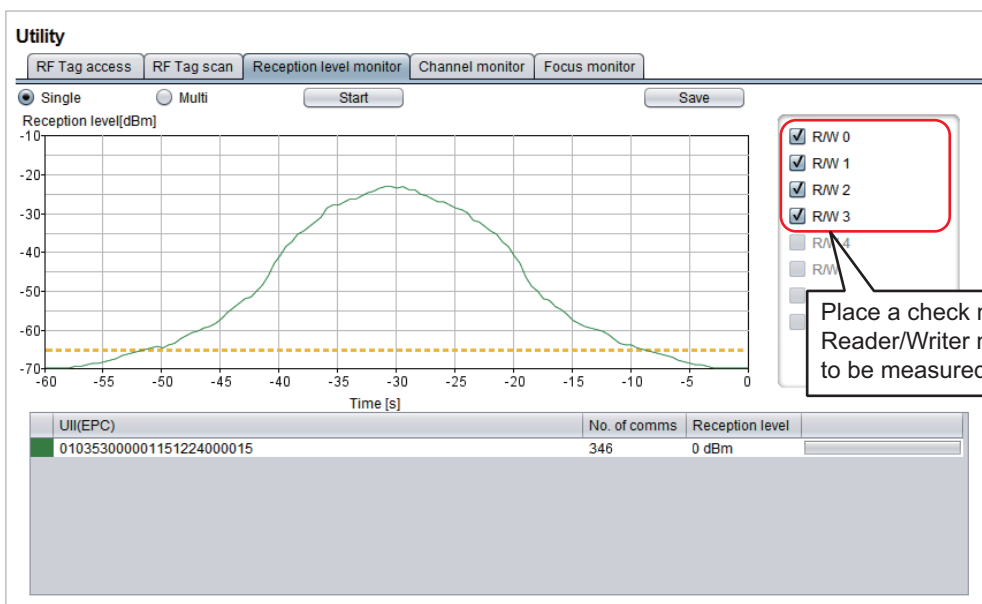

RW 0
 RW 1
 RW 2
 RW 3
 RW 4
 RW 5
 RW 6

Place a check mark at the Reader/Writer numbers to be measured.

Reception Level Measurement Results

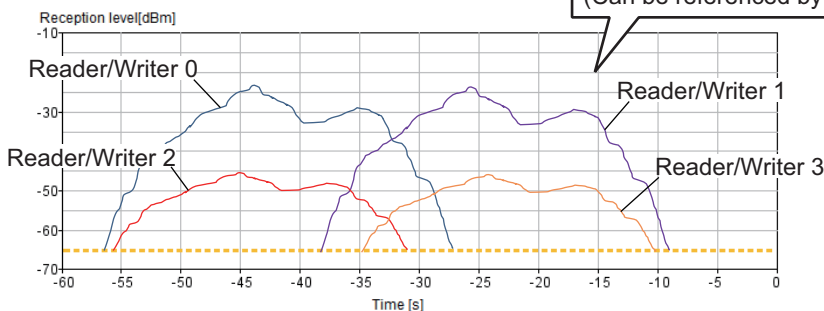

Time Series Graph of Measured Reception Level in each Reader/Writer (Can be referenced by file output)

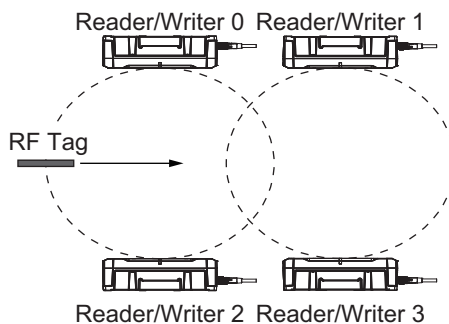

Graph Display on the Web Browser Interface

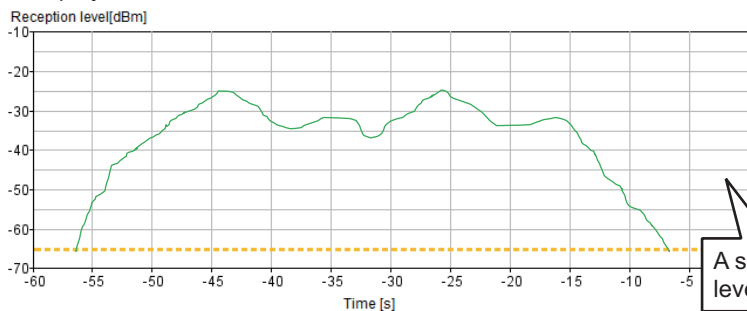

A single RF Tag is plotted by the highest reception level measured by each Reader/Writer.

● **Multiaccess**

On the Reception Level Monitor Tab Page, specify the Reader/Writer numbers to be measured in the Reader/Writers on the Multi-Reader/Writer configuration.

Click the **Start** Button after specification will start measurement by the subject Reader/Writers.

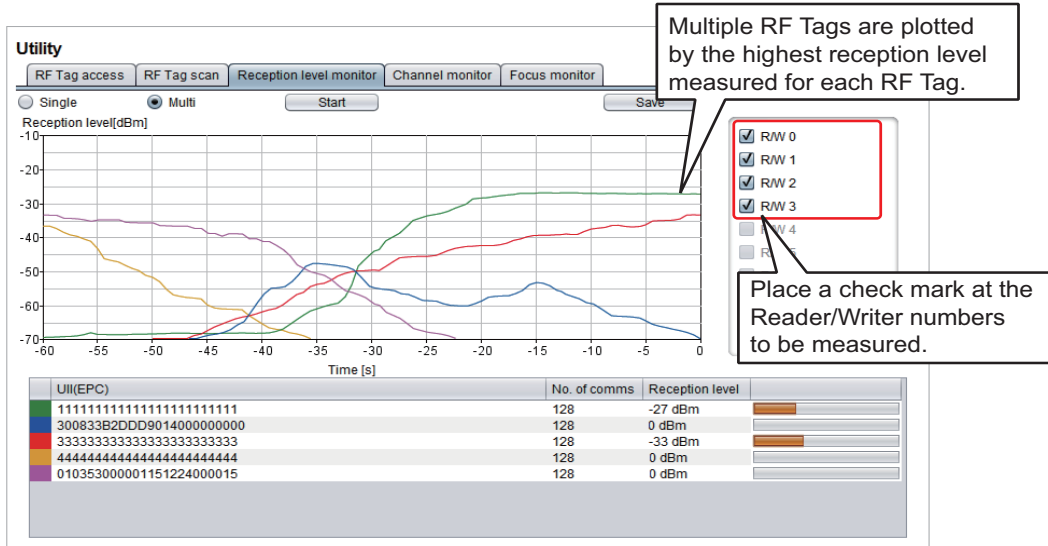

Multiple RF Tags are plotted by the highest reception level measured for each RF Tag.

Place a check mark at the Reader/Writer numbers to be measured.

Reception Level Measurement Results

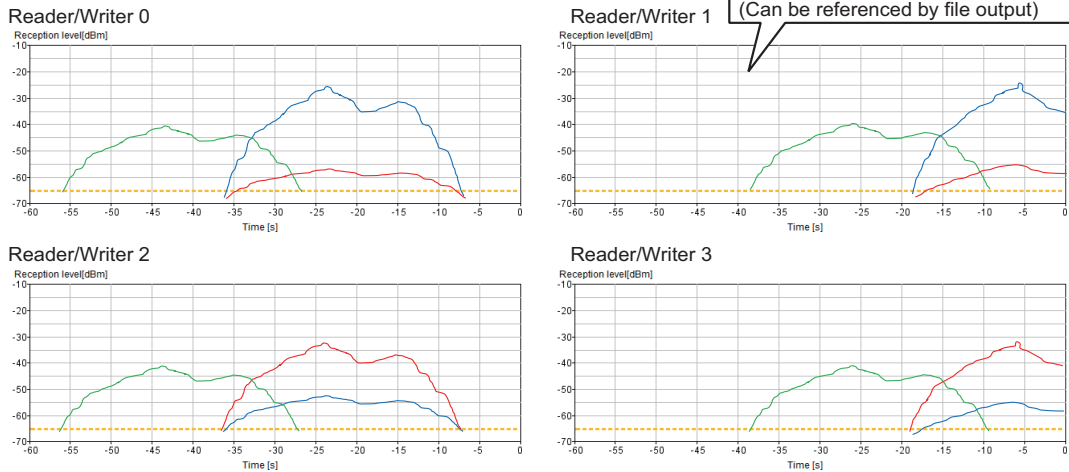

Graph Display on the Web Browser Interface

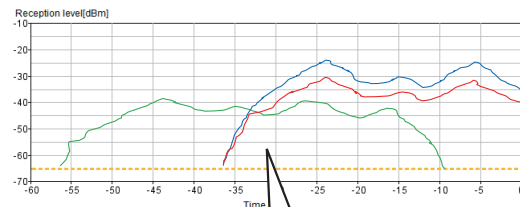

Multiple RF Tags are plotted by the highest reception level measured by each Reader/Writer.

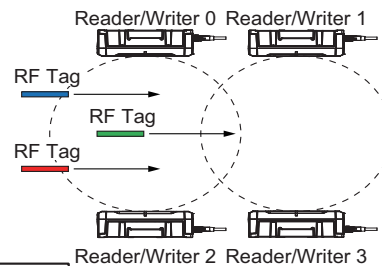

Channel monitor for Multiple Reader/Writers

You can use the Utilities View (click the **Utilities** Button and then click the **Channel monitor** Tab) on the Web browser interface, to check the channel settings separately for the master or slave Reader/Writer.

You can specify the target Reader/Writer number to monitor on the Channel monitor Tab Page.

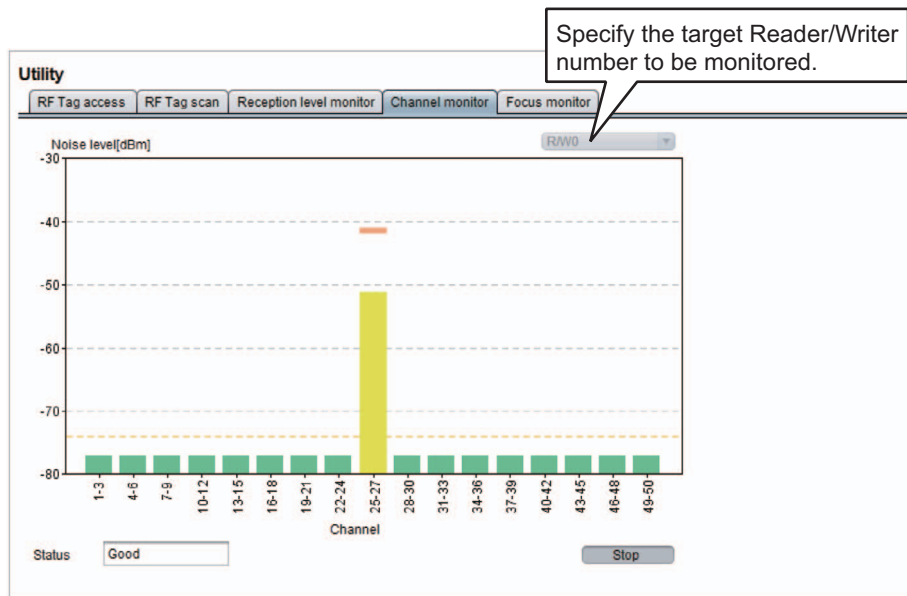

Command error log

If, with the Multi-Reader/Writer function enabled, the master Reader/Writer responds with a communications command error, the reader/writer number of the reader/writer where the error was detected is added and registered to the command error log. (For details, see the "Command Error Log" chapter)

Communications Diagnostics/RF Communications Diagnostics Log

With the Multi-Reader/Writer functions enabled, the Communications Diagnostics functions cannot be used as well.

Even if the communications diagnostic settings are enabled, diagnostic processing cannot be executed when executing communications commands.

7

Ethernet/IP Communications

This section provides an overview of Ethernet/IP communications and describes the communications format, communications commands, and communications procedure.

7-1	Outline	7-2
7-1-1	EtherNet/IP Communications Protocol	7-2
7-1-2	EtherNet/IP Communications with the Reader/Writer	7-3
7-1-3	Tag Data Link Setting Methods	7-4
7-1-4	Memory Assignments	7-7
7-1-5	Update Counter/Update Counter Response	7-10
7-1-6	V780 Commands	7-11
7-2	V780 Command Details	7-13
7-2-1	Single-access Communications Commands	7-13
7-2-2	Multiaccess Communications Commands	7-23
7-2-3	Reader/Writer Control Commands	7-27
7-2-4	Setting and Getting Reader/Writer Information Settings	7-30
7-2-5	Reader/Writer Setting Commands: Device Settings	7-33
7-2-6	Reader/Writer Setting Commands: Communications Settings	7-37
7-2-7	Maintenance Commands: Device Information	7-62
7-2-8	Maintenance Commands: Log Information	7-66
7-2-9	Maintenance Commands: RF Communications Information	7-71
7-2-10	Time Charts	7-77

7-1 Outline

7-1-1 EtherNet/IP Communications Protocol

Data is exchanged cyclically between Ethernet devices on the EtherNet/IP network using tag data links as shown below.

An example of connection with a CS/CJ-series CPU Unit is shown below.

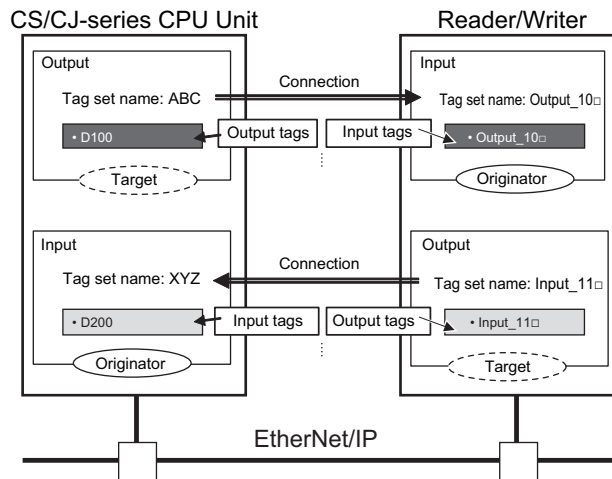

An example of connection with a NJ/NX-series CPU Unit is shown below.

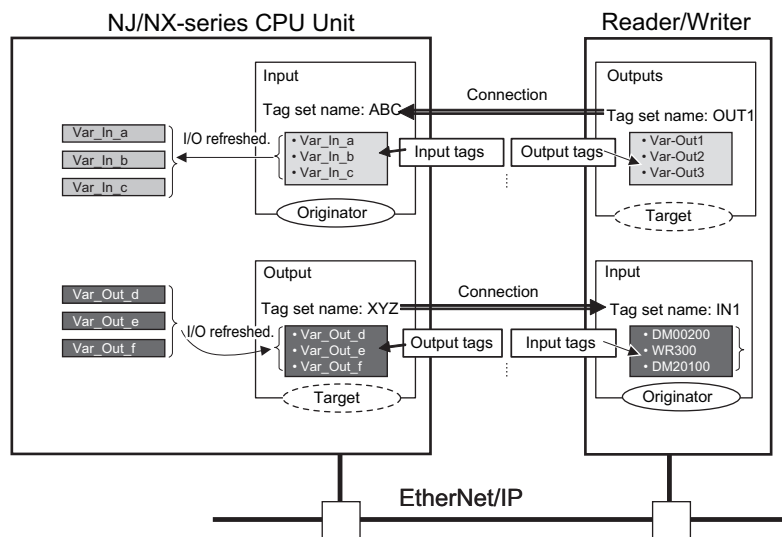

Data Exchange Method

To exchange data, a connection is opened between two EtherNet/IP devices.

One of the nodes requests the connection to open a connection with a remote node. The node that requests the connection is called the originator, and the node that receives the request is called the target. The host device (PLC) and Reader/Writer function as the originator and target.

Data Exchange Memory Locations

The memory locations that are used to exchange data across a connection are specified as tags.

You can specify memory addresses or variables in the host device (PLC) for tags.

A group of tags consists of an output tag set and an input tag set.

7-1-2 EtherNet/IP Communications with the Reader/Writer

You can use EtherNet/IP tag data links to communicate between the PLC and the Reader/Writer to perform control via command/response communications or to perform RF Tag communications. The following communications areas are prepared in the PLC to perform communications.

Area name	Description
Command Area	This is the area to which you write commands for the Reader/Writer to execute.
Response Area	This is the area to which the Reader/Writer writes the results of commands executed from the command area.

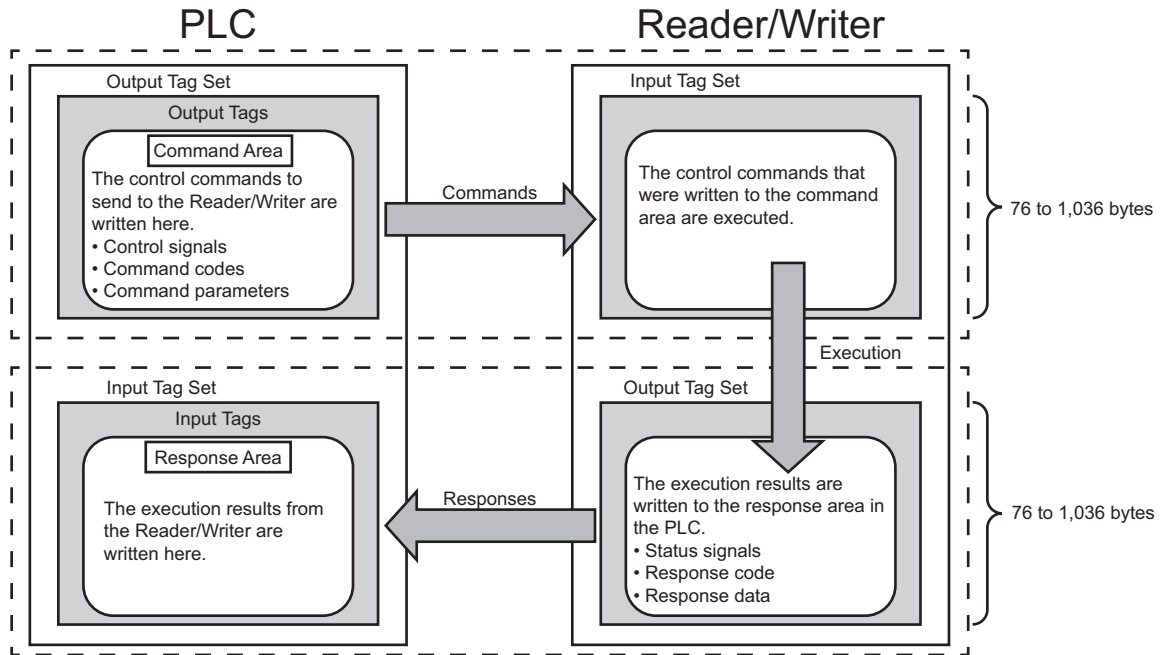

Precautions for Correct Use

The slave reader/writer (V780-HMD68-ETN-□□-S) disconnects the connection when it sends a communication command directly from the host device (client).

Use the slave reader/writer via the master reader/writer (V780-HMD68-EIP-□□).

7-1-3 Tag Data Link Setting Methods

This section describes how to set data links for EtherNet/IP.

The communications areas in the PLC for which data links are created to the Reader/Writer are specified as tags and tag sets, and the connections are set for tag data link communications.

To connect to OMRON PLCs or Controllers, you use the Network Configurator to set up tag data links (i.e., tags, tag sets, and connection settings). Refer to the following manuals for details on the tag data link settings that are made with the Network Configurator.

- *NJ-series CPU Unit Built-in EtherNet/IP Port User's Manual* (Cat. No. W506)
- *CS/CJ-series EtherNet/IP Units Operation Manual* (Cat. No. W465)
- *CJ-series EtherNet/IP Units Operation Manual for NJ-series CPU Unit* (Cat. No. W495)



Precautions for Correct Use

To set tag data links, an EDS file that defines the V780 connection is required. Download the EDS file from the OMRON website.

The communications areas in the PLC are set as tag data link connections as shown in the following table.

Tag and Tag Set Settings in the PLC

Setting item	Setting	
	Command Area	Response Area
Type of tags and tag set	Output tag sets	Input tag sets
Tag and tag set names	I/O memory addresses or variable names	I/O memory addresses or variable names
Data sizes	76, 268, 524, 1,036 bytes	766, 268, 524, 1,036 bytes

Select one of the following values for the data size according to the data size required to write or read an RF Tag in one operation.

Data size	Data size that can be read or written for an RF Tag in one operation
76 bytes	64 bytes
268 bytes	256 bytes
524 bytes	512 bytes
1,036 bytes	1,024 bytes

Setting Connections

192.168.1.200 V780-HMD68-EIP-US Edit Connection

It will add a connection configuration to originator device.
Please configure the Tag Set each of originator device and target device.

Connection I/O Type :

Originator Device

Node Address : 192.168.1.20

Comment : NJ301-1100

Input Tag Set :

Connection Type :

Output Tag Set :

Connection Type :

Target Device

Node Address : 192.168.1.200

Comment : V780-HMD68-EIP-US

Output Tag Set :

Input Tag Set :

Setting item	Description	
Originator device (PLC)	Input Tag Set	Tag set name on PLC - [76 to 1,036 bytes]
	Input connection types	Cannot be changed (Point to Point connection).
	Output Tag Set	Tag set name on PLC - [76 to 1,036 bytes]
	Output connection types	Cannot be changed (Point to Point connection).
Target device (Reader/Writer)	Output Tag Set	Input_10□[76 to 1,036Byte]
	Input Tag Set	Output_20□[76 to 1,036Byte]
Requested packet interval (RPI)	User specified (2.0 to 10,000 ms, default: 10.0 ms)	



Precautions for Correct Use

- If I/O memory addresses are specified for the communications areas, the information in the communications areas will be cleared when the operating mode of the PLC changes unless addresses in the CIO Area, which are maintained, are specified.
- The following assembly object is required to specify instances when the EDS file is not used.

Parameter name	Set value	Remarks
Instance ID	100	Output connection (76-byte tag set and tags)
	101	Output connection (268-byte tag set and tags)
	102	Output connection (524-byte tag set and tags)
	103	Output connection (1,036-byte tag set and tags)
	110	Input connection (76-byte tag set and tags)
	111	Input connection (268-byte tag set and tags)
	112	Input connection (524-byte tag set and tags)
	113	Input connection (1,036-byte tag set and tags)



Precautions for Correct Use

- If you connect to an OMRON master, the maximum data size for one tag data link connection depends on the model of the master. Use the sizes in the following table for reference.

EtherNet/IP master	Maximum data size per connection	Recommended data size setting for tag or tag set.
NX701 CPU Unit	1,444 bytes	1,036 bytes
NJ-series CPU Unit	600 bytes	524 bytes
CJ2HseriesCPUunit (Built-in EtherNet/IP function)	1,444 bytes	1,036 bytes
CJ2M seriesCPUunit (Built-in EtherNet/IP function)	1,280 bytes	1,036 bytes
EtherNet/IP Unit (EIP21)	1,444 bytes	1,036 bytes

- If you change the data size during communications, the connection will be closed. Cycle the power supply to the Reader/Writer again.

7-1-4 Memory Assignments

This section describes the memory assignments for the Command Area and Response Area in the PLC.

Memory is aligned in 16-bit units. The bit order for each field is little endian.

Command Area (from PLC Originator to Reader/Writer Target)

I/O mem- ory off- set	Bit															
	15	14	13	12	11	10	9	8	7	6	5	4	3	2	1	0
+0	Resv	Resv	Resv	Resv	Resv	Resv	Resv	Resv	Resv	Resv	Resv	Resv	Resv	Resv	Resv	EXE
+1	Command Code															
+2	Command Parameter 1															
+3	Command Parameter 2															
+4	Reserved Area															
+5	Update Counter Response															
+6	Command Data															
:	(The format depends on the command.)															
+N																

*. Reserved (resv) bits are for future expansion. Do not turn them ON and OFF.

Signal/data	Name	Data type	Size	Description
EXE	Command Execution	BOOL	1 bit	<ul style="list-style-type: none"> This bool requests the Reader/Writer to execute a command. When the Reader/Writer detects that this signal has turned ON, it executes the command specified by the "Command code". Moreover, when the Reader/Writer detects that this signal has turned OFF during the execution of the RF Tag communications command, it suspends/cancels the communications processing.
CmdCode	Command Code	WORD	2 bytes	This word stores the command code.
CmdParam1	Command Parameter 1	WORD	2 bytes	These words store the command parameters.
CmdParam2	Command Parameter 2	WORD	2 bytes	
Reserved	Reserved Area	WORD	2 bytes	This is an unused area for arranging the command data start position in a 4-byte boundary. * 00 hex fixed
Cnt Response	Update Counter Response	WORD	2 bytes	This word specifies the update count of the execution results received by the host device at the end of the reception of the results of continuous execution of the command from the RFID sensor unit. It indicates the value incremented by +1 each time the execution results are received. The count starts from 0 when command execution is started. The count value returns to 0 after reaching 65,535.
CmdData	Command Data	---	---	These words store the command data. Refer to the sections for individual commands for details.

Response Area (from Reader/Writer Target to PLC Originator)

I/O memory off-set	Bit															
	15	14	13	12	11	10	9	8	7	6	5	4	3	2	1	0
+0	Resv	Resv	Resv	Resv	Resv	Resv	Resv	RF_WAR	SYS_ERR	RF_ERR	CMD_ERR	Resv	ERR	NORM	BUSY	READY
+1	Error code															
+2	Response Information 1															
+3	Response Information 2															
+4	Response Information 3															
+5	Update Counter Response															
+6	Response Data (The format depends on the command.)															
:																
+N																

*. Reserved (Resv) bits are for future expansion. They always output 0.

Signal/data	Name	Data type	Size	Description
READY *1	Ready	BOOL	1 bit	This bit turns ON when the Reader/Writer completes preparations and is ready to receive a command. It is OFF when a command is being executed.
BUSY	Command Execution Active	BOOL	1 bit	This bit is ON while the Reader/Writer is executing a command. It is OFF when a command is not being executed.
NORM *2	Command Completion	BOOL	1 bit	This bit turns ON when the Reader/Writer completes the execution of the command. It turns OFF when the EXE signal is turned OFF. Alternatively, it turns ON and OFF in sync with the increment of the update counter.
ERR *3	Error	BOOL	1 bit	This bit turns ON when the Reader/Writer returns an error response. It turns OFF when the EXE signal is turned OFF. Alternatively, it turns ON and OFF in sync with the increment of the update counter.
CMD_ERR	Command error	BOOL	1 bit	This bit turns ON when the Reader/Writer returns a command error response. It turns ON and OFF in sync with ERR.
RF_ERR	RF Tag Communications Error	BOOL	1 bit	This bit turns ON when the Reader/Writer returns an RF Tag communications error response. It turns ON and OFF in sync with ERR.
SYS_ERR	Fatal Error	BOOL	1 bit	This bit turns ON when the Reader/Writer returns a fatal error response. It turns ON and OFF in sync with ERR.
RF_WAR	Unstable Communications	BOOL	1 bit	This bit turns ON when the diagnostics result of execution of an RF Tag communications command by the Reader/Writer indicates that communications are unstable. It turns ON and OFF in sync with NORM.
ErrCode	Error code	WORD	2 bytes	This word stores the error code.
ResplInfo1	Response Information 1	WORD	2 bytes	This word stores the Reader/Writer number.
ResplInfo2	Response Information 2	WORD	2 bytes	This word stores communications diagnostic results.
ResplInfo3	Response Information 3	WORD	2 bytes	This word stores the reception level.

Signal/data	Name	Data type	Size	Description
Cnt	Update Counter	WORD	2 bytes	This word indicates the count value that is incremented by +1 each time the execution result is updated to the next execution result during continuous execution of the command by the RF sensor unit. If there is no change in the count value from the previous input, it implies "No update of execution results". The count value starts from 0 when command execution is started. The count value returns to 0 after reaching 65,535.
RespData	Response Data	---	---	These words store the response data. Refer to the sections for individual commands for details.

- *1. READY is used for testing RF Tag communications from the Web browser, or for acquiring exclusion from settings change.
- *2. The start timing of one-time lighting of NORM LED (green) is synchronous with the time the NORM signal turns ON.
- *3. The start timing of one-time lighting of ERR LED (red) is synchronous with the time the ERR signal turns ON.

7-1-5 Update Counter/Update Counter Response

Update Counter

This word indicates the count value that is incremented by +1 each time the execution result is updated during continuous execution of the command by the Reader/Writer.

If there is no change in the count value from the previous input, it implies “No update of execution results”.

The count value starts from 0 when command execution is started. The count value returns to 0 after reaching 65535.

Signal/data	Name	Data type	Size
Cnt	Update Counter	WORD	2 bytes



Additional Information

Used when determining the update of communication results.

Update Counter Response

Specifies the update count of the execution results received by the host device during reception of the results of continuous execution of the command from the Reader/Writer.

It indicates the value incremented by +1 each time the execution results are received.

The count value starts from 0 when command execution is started. The count value returns to 0 after reaching 65535.

Signal/data	Name	Data type	Size
Cnt Response	Update Counter Response	WORD	2 bytes



Additional Information

Used when notifying the acquisition of the updated communication results to the Reader/Writer.

7-1-6 V780 Commands

Command code

The following table lists the command codes that you can specify for execution by the Reader/Writer. Set these codes in the Command Code field in the command area.

Classification	Command Code	Command name	Reference
RF Tag communications (Single-access)	0001 hex	READ ID	P. 7-13
	0002 hex	ID WRITE	P. 7-14
	0003 hex	READ DATA	P. 7-15
	0004 hex	WRITE DATA	P. 7-17
	0005 hex	LOCK	P. 7-19
	0006 hex	DATA FILL	P. 7-21
RF Tag communications (Multiaccess)	0203 hex	MULTIACCESS ID READ	P. 7-23
	0204 hex	MULTIACCESS DATA READ	P. 7-25
Reader/Writer control	1001 hex	INITIALIZE	P. 7-27
	1002 hex	RESET	P. 7-28
	1004 hex	RESET FOCUS	P. 7-29
Reader/Writer information acquisition	2001 hex	SET TCP/IP COMMUNICATIONS CONDITIONS	P. 7-30
	2002 hex	GET TCP/IP COMMUNICATIONS CONDITIONS	P. 7-31
	200B hex	SET MODEL NAME	
Reader/Writer setting commands (Network settings)	5003 hex	SET MULTI-READER/WRITER CONFIGURATION	P. 7-33
	5004 hex	GET MUTLI-READER/WRITER CONFIGURATION	
	4007 hex	GET MUTLI-READER/WRITER STATUS	P. 7-36
Reader/Writer setting commands (Communications settings)	3001 hex	SET TAG COMMUNICATIONS CONDITIONS	P. 7-37
	3002 hex	GET TAG COMMUNICATIONS CONDITIONS	P. 7-39
	3003 hex	SET TRANSMISSION POWER	P. 7-40
	3004 hex	GET TRANSMISSION POWER	P. 7-42
	3005 hex	SET CHANNEL	P. 7-44
	3006 hex	GET CHANNEL	P. 7-46
	3007 hex	SET GEN2 SESSION	P. 7-48
	3008 hex	GET GEN2 SESSION	P. 7-49
	3009 hex	SET ACCESS PASSWORD	P. 7-50
	300A hex	GET ACCESS PASSWORD	P. 7-51
	300B hex	SET RF TAG SELECTION FILTER CONDITIONS	P. 7-52
	300C hex	GET RF TAG SELECTION FILTER CONDITIONS	P. 7-53
	300D hex	SET RSSI FILTER CONDITIONS	P. 7-54
	300E hex	GET RSSI FILTER CONDITIONS	P. 7-55
	300F hex	SET TRANSMISSION TIME	P. 7-56
3010 hex	GET TRANSMISSION TIME	P. 7-58	
3011 hex	SET SMOOTHING BUFFER	P. 7-60	
3012 hex	GET SMOOTHING BUFFER	P. 7-61	
Maintenance commands (Device information)	4001 hex	GET MODEL INFORMATION	P. 7-62
	4002 hex	GET FIRMWARE VERSION	P. 7-63
	4005 hex	GET TIME INFORMATION	P. 7-65
	4006 hex	SET TIME INFORMATION	P. 7-64
Maintenance commands (History information)	4101 hex	GET SYSTEM ERROR LOG	P. 7-66
	4102 hex	CLEAR SYSTEM ERROR LOG	P. 7-68
	4103 hex	GET COMMAND ERROR LOG	P. 7-69
Maintenance commands (Communications information)	4201 hex	GET RF TAG ADDITIONAL INFORMATION	P. 7-71
	4202 hex	GET NOISE LEVEL	P. 7-72
	4203 hex	GET COMMUNICATIONS DIAGNOSTIC INFORMATION	P. 7-73

Error code

These codes are set in the Error Code field in the response area.

If an error response is returned (i.e., an error code other than 0000 hex), a record is stored in the command error log in the Reader/Writer. Records are not stored for errors for which responses are not returned to the host device. Reader/Writer operating errors and system errors are recorded in the system error log in the Reader/Writer.



Additional Information

- For details on error codes, refer to 9-2 *Error Tables* on page 9-4.

Device information

The following table lists the device information that indicates the Reader/Writer in which the error occurred.

These codes are set in the Response Information 1 field in the response area.

Reader/Writer No.	Description
0000 hex	An error occurred in the processing of the master Reader/Writer.
0001 hex	An error occurred in Slave Reader/Writer No. 1 for multi-Reader/Writer.
0002 hex	An error occurred in Slave Reader/Writer No. 2 for multi-Reader/Writer.
0003 hex	An error occurred in Slave Reader/Writer No. 3 for multi-Reader/Writer.
0004 hex	An error occurred in Slave Reader/Writer No. 4 for multi-Reader/Writer.
0005 hex	An error occurred in Slave Reader/Writer No. 5 for multi-Reader/Writer.
0006 hex	An error occurred in Slave Reader/Writer No. 6 for multi-Reader/Writer.
0007 hex	An error occurred in Slave Reader/Writer No. 7 for multi-Reader/Writer.

Communications diagnostics result

The following table lists the communications diagnostic results that are obtained when the Reader/Writer communicates with an RF Tag.

If communications diagnostics are enabled, these codes are provided to indicate the cause when diagnostics indicate that communications are unstable.

This information is set in the Response Information 2 field in the response area. When this information is set, the RF_WAR (communications unstable) signal turns ON.

Reader/Writer No.	Description
FFFF hex	Error (Set when the error code is not normal.)
0000 hex	Normal
0001 hex	Insufficient power to send
0002 hex	Insufficient power to receive
0003 hex	Too much noise
0005 hex	Insufficient read data
0006 hex	Excessive read data

7-2 V780 Command Details

7-2-1 Single-access Communications Commands

READ ID

- **Function**

This command reads the ID code of the RF Tag in the communications field.

- **Command Area**

Signal/data	Data type	Size	Function
CmdCode/Command Code	WORD	2 bytes	0001 hex
CmdParam1/Command Parameter 1	WORD	2 bytes	0000 hex (Not used.)
CmdParam2/Command Parameter 2	WORD	2 bytes	0000 hex (Not used.)
Reserved/Reserved Area	WORD	2 bytes	0000 hex (Not used.)
Cnt Response/Update Counter Response	WORD	2 bytes	0000 hex (At command execution) The value is counted up due to a change in the update counter. For details, refer to 7-1-5 <i>Update Counter/Update Counter Response</i> on page 7-10.

- **Response Area**

Signal/data	Data type	Size	Function
ErrCode/Error Code	WORD	2 bytes	Error code
RespInfo1/Response Information 1	WORD	2 bytes	R/W no. of the Reader/Writer communicating with the RF Tag 0000 to 0007 hex
RespInfo2/Response Information 2	WORD	2 bytes	Communications diagnostics result When communications diagnostics is enabled: Set the communications diagnostics result When communications diagnostics is disabled: 0000 hex (fixed) For details, refer to <i>GET COMMUNICATIONS DIAGNOSTIC INFORMATION</i> on page 7-73.
RespInfo3/Response Information 3	WORD	2 bytes	Reception level FFFF to FF9D hex (-1 to -99 [dBm])
Cnt/Update Counter	WORD	2 bytes	0000 to FFFF hex The value is counted up due to a change in the response area. For details, refer to 7-1-5 <i>Update Counter/Update Counter Response</i> on page 7-10.
RespData/Response Data			
ID Data	ARRAY[] OF WORD	32 words (64 bytes)	ID data read from the RF Tag [0]: StoredPC The upper 5 bits are the EPC word length. [1 to 31]: EPC All bytes of the EPC code section that exceed the EPC word length in the StoredPC are filled with 00 hex.

ID WRITE

● Function

This command writes the ID code to the RF Tag in the communications range.

● Command Area

Signal/data	Data type	Size	Function
CmdCode/Command Code	WORD	2 bytes	0002 hex
CmdParam1/Command Parameter 1	WORD	2 bytes	EPC length Specifies the word size of the EPC code. 0000 to 001F hex (1 to 31)
CmdParam2/Command Parameter 2	WORD	2 bytes	0000 hex (Not used.)
Reserved/Reserved Area	WORD	2 bytes	0000 hex (Not used.)
Cnt Response/Update Counter Response	WORD	2 bytes	0000 hex (At command execution) The value is counted up due to a change in the update counter. For details, refer to <i>Update Counter/Update Counter Response</i> on page 7-10.
CmdData/Command Data	ARRAY[] OF WORD	Max 31 words 62 bytes	EPC code Gives the tag-specific information according to Gen2 standards. EPC data equivalent to the word size specified in the EPC length is set.

● Response Area

Signal/data	Data type	Size	Function
ErrCode/Error Code	WORD	2 bytes	Error code
RespInfo1/Response Information 1	WORD	2 bytes	R/W no. of the Reader/Writer communicating with the RF Tag 0000 to 0007 hex
RespInfo2/Response Information 2	WORD	2 bytes	Communications diagnostics result When communications diagnostics is enabled: Set the communications diagnostics result When communications diagnostics is disabled: 0000 hex (fixed) For details, refer to <i>GET COMMUNICATIONS DIAGNOSTIC INFORMATION</i> on page 7-73.
RespInfo3/Response Information 3	WORD	2 bytes	Reception level FFFF to FF9D hex (-1 to -99 [dBm])
Cnt/Update Counter	WORD	2 bytes	0000 to FFFF hex The value is counted up due to a change in the response area. For details, refer to <i>Update Counter/Update Counter Response</i> on page 7-10.
RespData/Response Data	ID Data	ARRAY[] OF WORD	32 words (64 bytes)
			ID data before writing [0]: StoredPC The upper 5 bits are the EPC word length. [1 to 31]: EPC All bytes of the EPC code section that exceed the EPC word length in the StoredPC are filled with 00 hex.

READ DATA

● Function

This command reads data from the RF Tag in the communications field.

● Command Area

Signal/data	Data type	Size	Function										
CmdCode/Command Code	WORD	2 bytes	0003 hex										
CmdParam1/Command Parameter 1	WORD	2 bytes	First address (in words) of the data read from the RF Tag 0000 to 07FF hex: Reserved area 1000 to 17FF hex: EPC area 2000 to 27FF hex: TID area 3000 to 3FFF hex: User area										
CmdParam2/Command Parameter 2	WORD	2 bytes	The maximum data size that you can read from an RF Tag depends on the data size setting (in words). The maximum data size that can be read is decided according to the data size of the response area. <table border="1" data-bbox="970 987 1469 1193"> <thead> <tr> <th>Response area</th> <th>Range that can be specified</th> </tr> </thead> <tbody> <tr> <td>Input_110</td> <td>0001 hex to 0020 hex</td> </tr> <tr> <td>Input_111</td> <td>0001 hex to 0080 hex</td> </tr> <tr> <td>Input_112</td> <td>0001 hex to 0100 hex</td> </tr> <tr> <td>Input_113</td> <td>0001 hex to 0200 hex</td> </tr> </tbody> </table>	Response area	Range that can be specified	Input_110	0001 hex to 0020 hex	Input_111	0001 hex to 0080 hex	Input_112	0001 hex to 0100 hex	Input_113	0001 hex to 0200 hex
Response area	Range that can be specified												
Input_110	0001 hex to 0020 hex												
Input_111	0001 hex to 0080 hex												
Input_112	0001 hex to 0100 hex												
Input_113	0001 hex to 0200 hex												
Reserved/Reserved Area	WORD	2 bytes	0000 hex (Not used.)										
Cnt Response/Update Counter Response	WORD	2 bytes	0000 hex (At command execution) The value is counted up due to a change in the update counter. For details, refer to <i>Update Counter/Update Counter Response</i> on page 7-10.										

● Response Area

Signal/data	Data type	Size	Function
ErrCode/Error Code	WORD	2 bytes	Error code
RespInfo1/Response Information 1	WORD	2 bytes	R/W no. of the Reader/Writer communicating with the RF Tag 0000 to 0007 hex
RespInfo2/Response Information 2	WORD	2 bytes	Communications diagnostics result When communications diagnostics is enabled: Set the communications diagnostics result When communications diagnostics is disabled: 0000 hex (fixed) For details, refer to <i>GET COMMUNICATIONS DIAGNOSTIC INFORMATION</i> on page 7-73.
RespInfo3/Response Information 3	WORD	2 bytes	Reception level FFFF to FF9D hex (-1 to -99 [dBm])

Signal/data	Data type	Size	Function		
Cnt/Update Counter	WORD	2 bytes	0000 to FFFF hex The value is counted up due to a change in the response area. For details, refer to <i>Update Counter/Update Counter Response</i> on page 7-10.		
RespData/Response Data					
Read data	ARRAY[] OF WORD	Max 1,024 bytes *1	Data (in words) read from the RF Tag		
			Response area	Range that can be specified	Maximum data size
			Input_110	0001 hex to 0020 hex	32
			Input_111	0001 hex to 0080 hex	128
			Input_112	0001 hex to 0100 hex	256
Input_113	0001 hex to 0200 hex	512			

*1. The size of 1,024 bytes can be read only during Output_113.

● **Operation Example**

Reading Four Words of Data Starting from Word Address 3456 Hex in the RF Tag

Command Area

Memory offset	Data name	bit15-12	bit11-8	bit7-4	bit3-0
+1	CmdCode	0	0	0	3
+2	CmdParam1	3	4	5	6
+3	CmdParam2	0	0	0	4
+4	Reserved	0	0	0	0
+5	Cnt Response	0	0	0	0



Response Area

Memory offset	Data name	bit15-12	bit11-8	bit7-4	bit3-0
+1	ErrCode	0	0	0	0
+2	RespInfo1	0	0	0	0
+3	RespInfo2	0	0	0	0
+4	RespInfo3	F	F	E	5
+5	Cnt	0	0	0	1
+6	RespData[0]	1	1	1	1
+7	RespData[1]	2	2	2	2
+8	RespData[2]	3	3	3	3
+9	RespData[3]	4	4	4	4

RF Tag Memory

User address	bit15-12	bit11-8	bit7-4	bit3-0
3456Hex	1	1	1	1
3457Hex	2	2	2	2
3458Hex	3	3	3	3
3459Hex	4	4	4	4

WRITE DATA

● Function

This command writes data to the RF Tag in the communications field.

● Command Area

Signal/data	Data type	Size	Function										
CmdCode/Command Code	WORD	2 bytes	0004 hex										
CmdParam1/Command Parameter 1	WORD	2 bytes	First word address of the data to write to the RF Tag (in words) 0000 to 07FF hex: Reserved area 1000 to 17FF hex: EPC area 2000 to 27FF hex: TID area 3000 to 3FFF hex: User area										
CmdParam2/Command Parameter 2	WORD	2 bytes	The maximum data size that you can write to an RF Tag depends on the data size setting (in words). Setting range: 0001 hex to 0200 hex (512 words) The maximum data size that can be written is decided according to the data size of the command area. <table border="1"> <thead> <tr> <th>Response area</th> <th>Range that can be specified</th> </tr> </thead> <tbody> <tr> <td>Output_100</td> <td>0001 hex to 0020 hex</td> </tr> <tr> <td>Output_101</td> <td>0001 hex to 0080 hex</td> </tr> <tr> <td>Output_102</td> <td>0001 hex to 0100 hex</td> </tr> <tr> <td>Output_103</td> <td>0001 hex to 0200 hex</td> </tr> </tbody> </table>	Response area	Range that can be specified	Output_100	0001 hex to 0020 hex	Output_101	0001 hex to 0080 hex	Output_102	0001 hex to 0100 hex	Output_103	0001 hex to 0200 hex
Response area	Range that can be specified												
Output_100	0001 hex to 0020 hex												
Output_101	0001 hex to 0080 hex												
Output_102	0001 hex to 0100 hex												
Output_103	0001 hex to 0200 hex												
Reserved/Reserved Area	WORD	2 bytes	0000 hex (Not used.)										
Cnt Response/Update Counter Response	WORD	2 bytes	0000 hex (At command execution) The value is counted up due to a change in the update counter. For details, refer to <i>Update Counter/Update Counter Response</i> on page 7-10.										
CmdData/Command Data	ARRAY[] OF WORD	Max 1,024 bytes *1	Data (in words) to be written to the RF Tag										

*1. A size of 1,024 bytes can be read only during Input_103.

To read data exceeding 1,024 bytes, it must be read over two times.

● Response Area

Signal/data	Data type	Size	Function
ErrCode/Error Code	WORD	2 bytes	Error code
RespInfo1/Response Information 1	WORD	2 bytes	R/W no. of the Reader/Writer communicating with the RF Tag 0000 to 0007 hex
RespInfo2/Response Information 2	WORD	2 bytes	Communications diagnostics result When communications diagnostics is enabled: Set the communications diagnostics result When communications diagnostics is disabled: 0000 hex (fixed) For details, refer to <i>GET COMMUNICATIONS DIAGNOSTIC INFORMATION</i> on page 7-73.
RespInfo3/Response Information 3	WORD	2 bytes	Reception level FFFF to FF9D hex (-1 to -99 [dBm])
Cnt/Update Counter	WORD	2 bytes	0000 to FFFF hex The value is counted up due to a change in the response area. For details, refer to <i>Update Counter/Update Counter Response</i> on page 7-10.
RespData/Response Data			
ID Data	ARRAY[] OF WORD	32 words (64 bytes)	ID data before writing [0]: StoredPC The upper 5 bits are the EPC word length. [1 to 31]: EPC All bytes of the EPC code section that exceed the EPC word length in the StoredPC are filled with 00 hex.

● Operation Example

Writing 1111222233334444 to Four Words Starting from Word Address 3456 Hex in the RF Tag

Command Area

Memory offset	Data name	bit15-12	bit11-8	bit7-4	bit3-0
+1	CmdCode	0	0	0	4
+2	CmdParam1	3	4	5	6
+3	CmdParam2	0	0	0	4
+4	Reserved	0	0	0	0
+5	Cnt Response	0	0	0	0
+6	CmdData[0]	1	1	1	1
+7	CmdData[1]	2	2	2	2
+8	CmdData[2]	3	3	3	3
+9	CmdData[3]	4	4	4	4



Response Area

Memory offset	Data name	bit15-12	bit11-8	bit7-4	bit3-0
+1	ErrCode	0	0	0	0
+2	RespInfo1	0	0	0	0
+3	RespInfo2	0	0	0	0
+4	RespInfo3	F	F	E	5
+5	Cnt	0	0	0	1
+6	RespData[0]	1	0	0	0
+7	RespData[1]	7	7	7	7
+8	RespData[2]	8	8	8	8
:	:	:	:	:	:
+37	RespData[31]	0	0	0	0

RF Tag Memory

User address	bit15-12	bit11-8	bit7-4	bit3-0
3456Hex	1	1	1	1
3457Hex	2	2	2	2
3458Hex	3	3	3	3
3459Hex	4	4	4	4

LOCK

● Function

This command locks or unlocks the memory of the RF Tag in the communications range.



Precautions for Correct Use

- When an RF Tag is locked, the specified password is written to the access password area in the RF Tag.
- If an RF Tag address error, RF Tag lock error, or RF tag system error occurs when locking an RF Tag, the access password area in the RF Tag will be cleared to all zeros.
- When an RF Tag is unlocked, the access password area in the RF Tag will be cleared to all zeros.

● Command Area

Signal/data	Data type	Size	Function
CmdCode/Command Code	WORD	2 bytes	0005 hex
CmdParam1/Command Parameter 1	WORD	2 bytes	Lock operation: Specifies locking or unlocking. 0000 hex: Unlock ^{*1} 0001 hex: Lock ^{*2, *3} * Specify one or more of the EPC area, TID area, user area, and access password.
CmdParam2/Command Parameter 2	WORD	2 bytes	Area to lock/unlock: Specifies one or more of the EPC, TID, and user areas as the area to lock or unlock. Bit 0: EPC area Bit 1: TID area Bit 2: User area Bit 3: Access password Bits 4 to 15: Reserved (Always 0) * If all zeros is specified, a command parameter error will occur.
Reserved/Reserved Area	WORD	2 bytes	0000 hex (Not used.)
Cnt Response/Update Counter Response	WORD	2 bytes	0000 hex (At command execution) The value is counted up due to a change in the update counter. For details, refer to <i>Update Counter/Update Counter Response</i> on page 7-10.
CmdData/Command Data			
Password	ARRAY [] OF BYTE	4 bytes	Specifies the access password to set in the Tag in 8-digit hexadecimal (32 bits) (00000000 hex). Locking: The access password to set in the RF Tag to lock. Unlocking: The access password in the RF Tag to unlock.

*1. When you unlock an area, specify all of the areas that have been locked.

*2. If you specify the EPC, TID, or user area, you will no longer be able to write data to that area.

*3. If you specify the access password, you will no longer be able to read the access password area.

● Response Area

Signal/data	Data type	Size	Function
ErrCode/Error Code	WORD	2 bytes	Error code
RespInfo1/Response Information 1	WORD	2 bytes	R/W no. of the Reader/Writer communicating with the RF Tag 0000 to 0007 hex
RespInfo2/Response Information 2	WORD	2 bytes	Communications diagnostics result When communications diagnostics is enabled: Set the communications diagnostics result When communications diagnostics is disabled: 0000 hex (fixed) For details, refer to <i>GET COMMUNICATIONS DIAGNOSTIC INFORMATION</i> on page 7-73.
RespInfo3/Response Information 3	WORD	2 bytes	Reception level FFFF to FF9D hex (-1 to -99 [dBm])
Cnt/Update Counter	WORD	2 bytes	0000 to FFFF hex The value is counted up due to a change in the response area. For details, refer to <i>Update Counter/Update Counter Response</i> on page 7-10.

DATA FILL

● Function

This command writes the specified data to the specified number of words beginning from the specified write start address. The specifications are made in the command.

● Command Area

Signal/data	Data type	Size	Function
CmdCode/Command Code	WORD	2 bytes	0006 hex
CmdParam1/Command Parameter 1	WORD	2 bytes	First word address of the data to write to the RF Tag (in words) 0000 to 07FF hex: Reserved area 1000 to 17FF hex: EPC area 2000 to 27FF hex: TID area 3000 to 3FFF hex: User area
CmdParam2/Command Parameter 2	WORD	2 bytes	Specify in 4-digit hexadecimal the number of words of data to fill. Setting range: 0000 hex or 0001 to 0800 hex <ul style="list-style-type: none"> If 0000 hex is specified for the number of fill words, the entire memory area will be filled. You cannot write data to more than one area with the same command.
Reserved/Reserved Area	WORD	2 bytes	0000 hex (Not used.)
Cnt Response/Update Counter Response	WORD	2 bytes	0000 hex (At command execution) The value is counted up due to a change in the update counter. For details, refer to <i>Update Counter/Update Counter Response</i> on page 7-10.
CmdData/Command Data			
	Fill data	WORD	2 bytes
			Fill data to write to the RF Tag (always one word)

● Response Area

Signal/data	Data type	Size	Function
ErrCode/Error Code	WORD	2 bytes	Error code
RespInfo1/Response Information 1	WORD	2 bytes	R/W no. of the Reader/Writer communicating with the RF Tag 0000 to 0007 hex
RespInfo2/Response Information 2	WORD	2 bytes	Communications diagnostics result When communications diagnostics is enabled: Set the communications diagnostics result When communications diagnostics is disabled: 0000 hex (fixed) For details, refer to <i>GET COMMUNICATIONS DIAGNOSTIC INFORMATION</i> on page 7-73.
RespInfo3/Response Information 3	WORD	2 bytes	Reception level FFFF to FF9D hex (-1 to -99 [dBm])
Cnt/Update Counter	WORD	2 bytes	0000 to FFFF hex The value is counted up due to a change in the response area. For details, refer to <i>Update Counter/Update Counter Response</i> on page 7-10.

● Operation Example

Writing 5A5A Hex to Four Words Starting from Word Address 3456 Hex in the RF Tag

Command Area

Memory offset	Data name	bit15-12	bit11-8	bit7-4	bit3-0
+1	CmdCode	0	0	0	6
+2	CmdParam1	3	4	5	6
+3	CmdParam2	0	0	0	4
+4	Reserved	0	0	0	0
+5	Cnt Response	0	0	0	0
+6	CmdData	5	A	5	A



Response Area

Memory offset	Data name	bit15-12	bit11-8	bit7-4	bit3-0
+1	ErrCode	0	0	0	0
+2	RespInfo1	0	0	0	0
+3	RespInfo2	0	0	0	0
+4	RespInfo3	F	F	E	5
+5	Cnt	0	0	0	1

RF Tag Memory

User address	bit15-12	bit11-8	bit7-4	bit3-0
3456Hex	5	A	5	A
3457Hex	5	A	5	A
3458Hex	5	A	5	A
3459Hex	5	A	5	A

7-2-2 Multiaccess Communications Commands

MULTIACCESS ID READ

● Function

This command specifies reading the IDs (i.e., the EPC codes) of the RF Tags in the communications range.

* It can also be used when the communications mode is Repeat.

● Command Area

Signal/data	Data type	Size	Function
CmdCode/Command Code	WORD	2 bytes	0203 hex
CmdParam1/Command Parameter 1	WORD	2 bytes	0000 hex (Not used.)
CmdParam2/Command Parameter 2	WORD	2 bytes	0000 hex (Not used.)
Reserved/Reserved Area	WORD	2 bytes	0000 hex (Not used.)
Cnt Response/Update Counter Response	WORD	2 bytes	0000 hex (At command execution) The value is counted up due to a change in the update counter. For details, refer to <i>Update Counter/Update Counter Response</i> on page 7-10.

● Response Area

Signal/data	Data type	Size	Function
ErrCode/Error Code	WORD	2 bytes	Error code
RespInfo1/Response Information 1	WORD	2 bytes	R/W no. of the Reader/Writer communicating with the RF Tag 0000 to 0007 hex
RespInfo2/Response Information 2	WORD	2 bytes	Communications diagnostics result When communications diagnostics is enabled: Set the communications diagnostics result When communications diagnostics is disabled: 0000 hex (fixed) For details, refer to <i>GET COMMUNICATIONS DIAGNOSTIC INFORMATION</i> on page 7-73.
RespInfo3/Response Information 3	WORD	2 bytes	Reception level FFFF to FF9D hex (-1 to -99 [dBm])
Cnt/Update Counter	WORD	2 bytes	0000 to FFFF hex The value is counted up due to a change in the response area. For details, refer to <i>Update Counter/Update Counter Response</i> on page 7-10.
RespData/Response Data			
StoredPC	WORD	2 bytes	Expresses the StoredPC in 2-digit hexadecimal. The upper 5 bits are the UII (EPC) word length.
UII (EPC code)	ARRAY[] OF WORD	0 to 31 words	Stores the tag-specific information according to Gen2 standards.

● Response Area (Error Response)

When a command error occurs, or when an RF Tag missing error occurs while the communications timeout is enabled, the format becomes as shown below.

Signal/data	Data type	Size	Function
ErrCode/Error Code	WORD	2 bytes	Error code
ResplInfo1/Response Information 1	WORD	2 bytes	0000 hex (Not used.)
ResplInfo2/Response Information 2	WORD	2 bytes	0000 hex (Not used.)
ResplInfo3/Response Information 3	WORD	2 bytes	0000 hex (Not used.)
Cnt/Update Counter	WORD	2 bytes	0000 to FFFF hex The value is counted up due to a change in the response area. For details, refer to <i>Update Counter/Update Counter Response</i> on page 7-10.

MULTIACCESS DATA READ

● Function

This command specifies reading data from the RF Tags in the communications range.

* It can also be used when the communications mode is Repeat.

● Command Area

Signal/data	Data type	Size	Function
CmdCode/Command Code	WORD	2 bytes	0204 hex
CmdParam1/Command Parameter 1	WORD	2 bytes	First address (in words) of the data read from the RF Tag 0000 to 07FF hex: Reserved area 1000 to 17FF hex: EPC area 2000 to 27FF hex: TID area 3000 to 3FFF hex: User area
CmdParam2/Command Parameter 2	WORD	2 bytes	First address (in words) of the data read from the RF Tag Setting range: 0001 hex to 0020 hex (32 words)
Reserved/Reserved Area	WORD	2 bytes	0000 hex (Not used.)
Cnt Response/Update Counter Response	WORD	2 bytes	0000 hex (At command execution) The value is counted up due to a change in the update counter. For details, refer to <i>Update Counter/Update Counter Response</i> on page 7-10.
CmdData/Command Data			
Options	ARRAY[] OF BYTE	2 bytes	Specifies with an option whether to add a PC code. 0000 hex: No option 0001 hex: With EPC code If you specify the existence of the EPC code with Output_110, a parameter error will occur since the size for returning the EPC code is not available.

● Response Area (for Output_110)

Signal/data	Data type	Size	Function
ErrCode/Error Code	WORD	2 bytes	Error code
RespInfo1/Response Information 1	WORD	2 bytes	R/W no. of the Reader/Writer communicating with the RF Tag 0000 to 0007 hex
RespInfo2/Response Information 2	WORD	2 bytes	Communications diagnostics result When communications diagnostics is enabled: Set the communications diagnostics result When communications diagnostics is disabled: 0000 hex (fixed) For details, refer to <i>GET COMMUNICATIONS DIAGNOSTIC INFORMATION</i> on page 7-73.
RespInfo3/Response Information 3	WORD	2 bytes	Reception level FFFF to FF9D hex (-1 to -99 [dBm])
Cnt/Update Counter	WORD	2 bytes	0000 to FFFF hex The value is counted up due to a change in the response area. For details, refer to <i>Update Counter/Update Counter Response</i> on page 7-10.
RespData/Response Data			
	Read data	WORD 32 words (64 bytes)	The data that was read from the RF Tag is attached. * The area that exceeds the data size is filled with zeros.

● Response Area (for Output_111, Output_112, Output_113)

Signal/data	Data type	Size	Function
ErrCode/Error Code	WORD	2 bytes	Error code
RespInfo1/Response Information 1	WORD	2 bytes	R/W no. of the Reader/Writer communicating with the RF Tag 0000 to 0007 hex
RespInfo2/Response Information 2	WORD	2 bytes	Communications diagnostics result When communications diagnostics is enabled: Set the communications diagnostics result When communications diagnostics is disabled: 0000 hex (fixed) For details, refer to <i>GET COMMUNICATIONS DIAGNOSTIC INFORMATION</i> on page 7-73.
RespInfo3/Response Information 3	WORD	2 bytes	Reception level FFFF to FF9D hex (-1 to -99 [dBm])
Cnt/Update Counter	WORD	2 bytes	0000 to FFFF hex The value is counted up due to a change in the response area. For details, refer to <i>Update Counter/Update Counter Response</i> on page 7-10.

Signal/data	Data type	Size	Function
RespData/Response Data			
Read data	WORD	32 words (64 bytes)	The data that was read from the RF Tag is attached. * The area that exceeds the data size is filled with zeros.
StoredPC	WORD	2 bytes	Expresses the StoredPC in 2-digit hexadecimal. The upper 5 bits are the UII (EPC) word length.
UII (EPC code)	ARRAY[] OF WORD	0 to 31 words	Stores the tag-specific information according to Gen2 standards.

7-2-3 Reader/Writer Control Commands

INITIALIZE

● Function

This command initializes the Reader/Writer settings. (That is, it returns them to the default settings.)

● Command Area

Signal/data	Data type	Size	Function
CmdCode/Command Code	WORD	2 bytes	1001 hex
CmdParam1/Command Parameter 1	WORD	2 bytes	0000 hex (Not used.)
CmdParam2/Command Parameter 2	WORD	2 bytes	0000 hex (Not used.)
Reserved/Reserved Area	WORD	2 bytes	0000 hex (Not used.)
Cnt Response/Update Counter Response	WORD	2 bytes	0000 hex (At command execution) The value is counted up due to a change in the update counter. For details, refer to <i>Update Counter/Update Counter Response</i> on page 7-10.

● Response Area

Signal/data	Data type	Size	Function
ErrCode/Command Code	WORD	2 bytes	Error code
RespInfo1/Response Information 1	WORD	2 bytes	0000 hex (Not used.)
RespInfo2/Response Information 2	WORD	2 bytes	0000 hex (Not used.)
RespInfo3/Response Information 3	WORD	2 bytes	0000 hex (Not used.)
Cnt/Update Counter	WORD	2 bytes	0000 to FFFF hex The value is counted up due to a change in the response area. For details, refer to <i>Update Counter/Update Counter Response</i> on page 7-10.

RESET

● Function

This command restarts the entire Reader/Writer.

● Command Area

Signal/data	Data type	Size	Function
CmdCode/Command Code	WORD	2 bytes	1002 hex
CmdParam1/Command Parameter 1	WORD	2 bytes	Options 0000 hex: Normal reset FFFF hex: Forced reset Normal reset: Reset is performed after the Reader/Writer is set to an idle state. Forced reset: Reset is performed immediately when the command is received, without waiting for the Reader/Writer to be set to an idle state.
CmdParam2/Command Parameter 2	WORD	2 bytes	0000 hex (Not used.)
Reserved/Reserved Area	WORD	2 bytes	0000 hex (Not used.)
Cnt Response/Update Counter Response	WORD	2 bytes	0000 hex (At command execution) The value is counted up due to a change in the update counter. For details, refer to <i>Update Counter/Update Counter Response</i> on page 7-10.

● Response Area

Signal/data	Data type	Size	Function
ErrCode/Command Code	WORD	2 bytes	Error code
RespInfo1/Response Information 1	WORD	2 bytes	0000 hex (Not used.)
RespInfo2/Response Information 2	WORD	2 bytes	0000 hex (Not used.)
RespInfo3/Response Information 3	WORD	2 bytes	0000 hex (Not used.)
Cnt/Update Counter	WORD	2 bytes	0000 to FFFF hex The value is counted up due to a change in the response area. For details, refer to <i>Update Counter/Update Counter Response</i> on page 7-10.

Note In the case of a forced reset, restart is performed without any output in the response area. During a normal reset, an output is performed in the response area.

RESET FOCUS

● Function

This command initializes the target level information of all the RF Tags that are being monitored by the Reader/Writer in Focus Mode.

● Command Area

Signal/data	Data type	Size	Function
CmdCode/Command Code	WORD	2 bytes	1004 hex
CmdParam1/Command Parameter 1	WORD	2 bytes	0000 hex (Not used.)
CmdParam2/Command Parameter 2	WORD	2 bytes	0000 hex (Not used.)
Reserved/Reserved Area	WORD	2 bytes	0000 hex (Not used.)
Cnt Response/Update Counter Response	WORD	2 bytes	0000 hex (At command execution) The value is counted up due to a change in the update counter. For details, refer to <i>Update Counter/Update Counter Response</i> on page 7-10.

● Response Area

Signal/data	Data type	Size	Function
ErrCode/Command Code	WORD	2 bytes	Error code
RespInfo1/Response Information 1	WORD	2 bytes	0000 hex (Not used.)
RespInfo2/Response Information 2	WORD	2 bytes	0000 hex (Not used.)
RespInfo3/Response Information 3	WORD	2 bytes	0000 hex (Not used.)
Cnt/Update Counter	WORD	2 bytes	0000 to FFFF hex The value is counted up due to a change in the response area. For details, refer to <i>Update Counter/Update Counter Response</i> on page 7-10.

7-2-4 Setting and Getting Reader/Writer Information Settings

SET TCP/IP COMMUNICATIONS CONDITIONS

● Function

This command sets the TCP/IP communications conditions of the Reader/Writer.

● Command Area

Signal/data	Data type	Size	Function
CmdCode/Command Code	WORD	2 bytes	2001 hex
CmdParam1/Command Parameter 1	WORD	2 bytes	0000 hex (Not used.)
CmdParam2/Command Parameter 2	WORD	2 bytes	0000 hex (Not used.)
Reserved/Reserved Area	WORD	2 bytes	0000 hex (Not used.)
Cnt Response/Update Counter Response	WORD	2 bytes	0000 hex (At command execution) The value is counted up due to a change in the update counter. For details, refer to <i>Update Counter/Update Counter Response</i> on page 7-10.

CmdData/Command Data

IP address setting method	WORD	2 bytes	IP address setting method to be set 0000 hex: Fixed setting 0001 hex: Obtain from BOOTP server 0002 hex: Obtain from BOOTP server as fixed settings Default setting: 0000 hex
IP address ^{*1}	DWORD	8 bytes	Fixed IP address to be set 00000000 to DFFFFFFF hex Default setting: C0A801C8 hex
Subnet mask ^{*1}	DWORD	8 bytes	Subnet mask to be set FF000000 hex to FFFFFFFF hex Default setting: FFFFFFF0 hex
Gateway address ^{*1}	DWORD	8 bytes	Gateway address to be set 00000000 to DFFFFFFF hex Default setting: CAA801FE hex

*1. Specify 00000000 hex for any IP address setting method other than using a fixed IP address.

● Response Area

Signal/data	Data type	Size	Function
ErrCode/Command Code	WORD	2 bytes	Error code
RespInfo1/Response Information 1	WORD	2 bytes	0000 hex (Not used.)
RespInfo2/Response Information 2	WORD	2 bytes	0000 hex (Not used.)
RespInfo3/Response Information 3	WORD	2 bytes	0000 hex (Not used.)
Cnt/Update Counter	WORD	2 bytes	0000 to FFFF hex The value is counted up due to a change in the response area. For details, refer to <i>Update Counter/Update Counter Response</i> on page 7-10.

GET TCP/IP COMMUNICATIONS CONDITIONS

● Function

This command is used to check the TCP/IP communications conditions that are set in the Reader/Writer.

● Command Area

Signal/data	Data type	Size	Function
CmdCode/Command Code	WORD	2 bytes	2002 hex
CmdParam1/Command Parameter 1	WORD	2 bytes	0000 hex (Not used.)
CmdParam2/Command Parameter 2	WORD	2 bytes	0000 hex (Not used.)
Reserved/Reserved Area	WORD	2 bytes	0000 hex (Not used.)
Cnt Response/Update Counter Response	WORD	2 bytes	0000 hex (At command execution) The value is counted up due to a change in the update counter. For details, refer to <i>Update Counter/Update Counter Response</i> on page 7-10.

● Response Area

Signal/data	Data type	Size	Function
ErrCode/Error Code	WORD	2 bytes	Error code
RespInfo1/Response Information 1	WORD	2 bytes	0000 hex (Not used.)
RespInfo2/Response Information 2	WORD	2 bytes	0000 hex (Not used.)
RespInfo3/Response Information 3	WORD	2 bytes	0000 hex (Not used.)
Cnt/Update Counter	WORD	2 bytes	0000 to FFFF hex The value is counted up due to a change in the response area. For details, refer to <i>Update Counter/Update Counter Response</i> on page 7-10.

RespData/Response Data

IP address setting method	WORD	2 bytes	IP address setting method that is set 0000 hex: Fixed setting 0001 hex: Obtain from BOOTP server 0002 hex: Obtain from BOOTP server as fixed settings Default setting: 0000 hex
IP address ^{*1}	DWORD	8 bytes	Fixed IP address that is set 00000000 to DFFFFFFF hex Default setting: C0A801C8 hex
Subnet mask ^{*1}	DWORD	8 bytes	Subnet mask that is set FF000000 to FFFFFFFF hex Default setting: FFFFFFF0 hex
Gateway address ^{*1}	DWORD	8 bytes	Gateway address that is set 00000000 to DFFFFFFF hex Default setting: CAA801FE hex

*1. For any IP address setting method except for using a fixed address, 00000000 hex is returned.

SET DEVICE NAME

● Function

This command is used to set or clear a name for the Reader/Writer.

● Command Area

Signal/data	Data type	Size	Function
CmdCode/Command Code	WORD	2 bytes	200B hex
CmdParam1/Command Parameter 1	WORD	2 bytes	0000 hex (Not used.)
CmdParam2/Command Parameter 2	WORD	2 bytes	0000 hex (Not used.)
Reserved/Reserved Area	WORD	2 bytes	0000 hex (Not used.)
Cnt Response/Update Counter Response	WORD	2 bytes	0000 hex (At command execution) The value is counted up due to a change in the update counter. For details, refer to <i>Update Counter/Update Counter Response</i> on page 7-10.
CmdData/Command Data			
Device name	ARRAY[] OF BYTE	64 bytes	ASCII characters *1, 64 bytes max. (Filled with up to 63 ASCII characters plus the end code (00 hex)) Specify 00 hex for all bytes to clear the device name. Default setting: 00 hex for all bytes

*1. The device name is given with ASCII characters 20 hex (space) to 7E hex (~).

● Response Area

Signal/data	Data type	Size	Function
ErrCode/Command Code	WORD	2 bytes	Error code
RespInfo1/Response Information 1	WORD	2 bytes	0000 hex (Not used.)
RespInfo2/Response Information 2	WORD	2 bytes	0000 hex (Not used.)
RespInfo3/Response Information 3	WORD	2 bytes	0000 hex (Not used.)
Cnt/Update Counter	WORD	2 bytes	0000 to FFFF hex The value is counted up due to a change in the response area. For details, refer to <i>Update Counter/Update Counter Response</i> on page 7-10.

7-2-5 Reader/Writer Setting Commands: Device Settings

SET MULTI-READER/WRITER CONFIGURATION

● Function

This command sets the multi-Reader/Writer configuration. The settings are enabled from the next startup.

● Command Area

Signal/data	Data type	Size	Function
CmdCode/Command Code	WORD	2 bytes	5003 hex
CmdParam1/Command Parameter 1	WORD	2 bytes	0000 hex (Not used.)
CmdParam2/Command Parameter 2	WORD	2 bytes	0000 hex (Not used.)
Reserved/Reserved Area	WORD	2 bytes	0000 hex (Not used.)
Cnt Response/Update Counter Response	WORD	2 bytes	0000 hex (At command execution) The value is counted up due to a change in the update counter. For details, refer to <i>Update Counter/Update Counter Response</i> on page 7-10.
CmdData/Command Data			
Multi-Reader/Writer Mode	WORD	2 bytes	Sets whether the multi-Reader/Writer Mode is enabled or disabled. 0000 hex: Disable 0001 hex: Enable Default setting: 0000 hex
Number of Slave Reader/Writers	WORD	2 bytes	Sets the number of Slave Readers/Writers. 0000 to 0007 hex Default setting: 0000 hex
Slave Reader/Writer 1	DWORD	4 bytes	Specifies the IP address of Slave Reader/Writer 1. Setting range: 00000000 to DFFFFFFF hex Example) C0A801C9 (192.168.1.201) Default setting: 00000000 hex
Slave Reader/Writer 2	DWORD	4 bytes	Specifies the IP address of Slave Reader/Writer 2. Setting range: 00000000 to DFFFFFFF hex Example) C0A801CA (192.168.1.202) Default setting: 00000000 hex
...
Slave Reader/Writer 6	DWORD	4 bytes	Specifies the IP address of Slave Reader/Writer 6. Setting range: 00000000 to DFFFFFFF hex Example) C0A801CE (192.168.1.206) Default setting: 00000000 hex
Slave Reader/Writer 7	DWORD	4 bytes	Specifies the IP address of Slave Reader/Writer 7. Setting range: 00000000 to DFFFFFFF hex Example) C0A801CF (192.168.1.207) Default setting: 00000000 hex

● Response Area

Signal/data	Data type	Size	Function
ErrCode/Command Code	WORD	2 bytes	Error code
RespInfo1/Response Information 1	WORD	2 bytes	0000 hex (Not used.)
RespInfo2/Response Information 2	WORD	2 bytes	0000 hex (Not used.)
RespInfo3/Response Information 3	WORD	2 bytes	0000 hex (Not used.)
Cnt/Update Counter	WORD	2 bytes	0000 to FFFF hex The value is counted up due to a change in the response area. For details, refer to <i>Update Counter/Update Counter Response</i> on page 7-10.

GET MUTLI-READER/WRIER CONFIGURATION

● Function

This command is used to check the Multi-Reader/Writer configuration set in the Multi-Reader/Writer.

● Command Area

Signal/data	Data type	Size	Function
CmdCode/Command Code	WORD	2 bytes	5004 hex
CmdParam1/Command Parameter 1	WORD	2 bytes	0000 hex (Not used.)
CmdParam2/Command Parameter 2	WORD	2 bytes	0000 hex (Not used.)
Reserved/Reserved Area	WORD	2 bytes	0000 hex (Not used.)
Cnt Response/Update Counter Response	WORD	2 bytes	0000 hex (At command execution) The value is counted up due to a change in the update counter. For details, refer to <i>Update Counter/Update Counter Response</i> on page 7-10.

● Response Area

Signal/data	Data type	Size	Function
ErrCode/Error Code	WORD	2 bytes	Error code
RespInfo1/Response Information 1	WORD	2 bytes	0000 hex (Not used.)
RespInfo2/Response Information 2	WORD	2 bytes	0000 hex (Not used.)
RespInfo3/Response Information 3	WORD	2 bytes	0000 hex (Not used.)
Cnt/Update Counter	WORD	2 bytes	0000 to FFFF hex The value is counted up due to a change in the response area. For details, refer to <i>Update Counter/Update Counter Response</i> on page 7-10.

RespData/Response Data

Multi-Reader/Writer Mode	WORD	2 bytes	Expresses whether the multi-Reader/Writer Mode is enabled or disabled. 0000 hex: Disable 0001 hex: Enable Default setting: 0000 hex
Number of Slave Reader/Writers	WORD	2 bytes	Expresses the number of Slave Readers/Writers. 0000 to 0007 hex Default setting: 0000 hex
Slave Reader/Writer 1	DWORD	4 bytes	Expresses the IP address of Slave Reader/Writer 1. Example) C0A801C9 (192.168.1.201) Default setting: 00000000 hex
Slave Reader/Writer 2	DWORD	4 bytes	Expresses the IP address of Slave Reader/Writer 2. Example) C0A801CA (192.168.1.202) Default setting: 00000000 hex
...
Slave Reader/Writer 6	DWORD	4 bytes	Expresses the IP address of Slave Reader/Writer 6. Example) C0A801CE (192.168.1.206) Default setting: 00000000 hex
Slave Reader/Writer 7	DWORD	4 bytes	Expresses the IP address of Slave Reader/Writer 7. Example) C0A801CF (192.168.1.207) Default setting: 00000000 hex

GET MUTLI-READER/WRITER STATUS

● Function

This command gets the multi-Reader/Writer status.

● Command Area

Signal/data	Data type	Size	Function
CmdCode/Command Code	WORD	2 bytes	4007 hex
CmdParam1/Command Parameter 1	WORD	2 bytes	0000 hex (Not used.)
CmdParam2/Command Parameter 2	WORD	2 bytes	0000 hex (Not used.)
Reserved/Reserved Area	WORD	2 bytes	0000 hex (Not used.)
Cnt Response/Update Counter Response	WORD	2 bytes	0000 hex (At command execution) The value is counted up due to a change in the update counter. For details, refer to <i>Update Counter/Update Counter Response</i> on page 7-10.

● Response Area

Signal/data	Data type	Size	Function
ErrCode/Error Code	WORD	2 bytes	Error code
RespInfo1/Response Information 1	WORD	2 bytes	0000 hex (Not used.)
RespInfo2/Response Information 2	WORD	2 bytes	0000 hex (Not used.)
RespInfo3/Response Information 3	WORD	2 bytes	0000 hex (Not used.)
Cnt/Update Counter	WORD	2 bytes	0000 to FFFF hex The value is counted up due to a change in the response area. For details, refer to <i>Update Counter/Update Counter Response</i> on page 7-10.

RespData/Response Data

Reader/Writer 0 (Master Reader/Writer)	WORD	2 bytes	Expresses the status of multi-Reader/Writer Mode of the master Reader/Writer. 0000 hex: Disable 1000 hex: Field Extension Mode starting ^{*1} 1001 hex: Field Extension Mode operating ^{*1}
Slave Reader/Writer 1 to 7 (Slave Reader/Writer)	ARRAY[] OF WORD	14 bytes	Expresses the status of Slave Reader/Writer 1 to 7. 0000 hex: Not registered 0001 hex: Connected 0002 hex: Not connected 0003 hex: Communications failure ^{*2}

*1. To be in the operating state, it is necessary to ensure that the connection process of all Slave Readers/Writers is complete.

*2. After connecting, the state is same as when communications with the Slave Readers/Writers has failed. If communications with the Slave Readers/Writers are successful, the state transits from Communications failure to Connected.

7-2-6 Reader/Writer Setting Commands: Communications Settings

SET TAG COMMUNICATIONS CONDITIONS

● Function

This command sets the communications conditions for the Reader/Writer.

● Command Area

Signal/data	Data type	Size	Function
CmdCode/Command Code	WORD	2 bytes	3001 hex
CmdParam1/Command Parameter 1	WORD	2 bytes	0000 hex (Not used.)
CmdParam2/Command Parameter 2	WORD	2 bytes	0000 hex (Not used.)
Reserved/Reserved Area	WORD	2 bytes	0000 hex (Not used.)
Cnt Response/Update Counter Response	WORD	2 bytes	0000 hex (At command execution) The value is counted up due to a change in the update counter. For details, refer to <i>Update Counter/Update Counter Response</i> on page 7-10.
CmdData/Command Data			
RF communication mode	WORD	2 bytes	Specifies the communications mode. 0000 hex: Once 0001 hex: Auto 0002 hex: Focus 0003 hex: Repeat Default setting: 0000 hex
Communications Speed	WORD	2 bytes	Specifies the communications speed. 0000 hex: Auto 0001 hex: High speed 0002 hex: Normal speed Default setting: 0000 hex
RF communication timeout time	WORD	2 bytes	Specifies the RF communications timeout time. 0001 hex to EA60 hex (1 to 60,000 [msec]) Default setting: 00FA hex (250 msec)
Write Verification	WORD	2 bytes	Specifies whether to perform write verification. 0000 hex: Do not verify. 0001 hex: Verify Default setting: 0001 hex
Communications Diagnostics	WORD	2 bytes	Specifies whether to perform communications diagnostics. 0000 hex: Do not verify. 0001 hex: Verify Default setting: 0000 hex

● **Response Area**

Signal/data	Data type	Size	Function
ErrCode/Command Code	WORD	2 bytes	Error code
RespInfo1/Response Information 1	WORD	2 bytes	0000 hex (Not used.)
RespInfo2/Response Information 2	WORD	2 bytes	0000 hex (Not used.)
RespInfo3/Response Information 3	WORD	2 bytes	0000 hex (Not used.)
Cnt/Update Counter	WORD	2 bytes	0000 to FFFF hex The value is counted up due to a change in the response area. For details, refer to <i>Update Counter/Update Counter Response</i> on page 7-10.

GET TAG COMMUNICATIONS CONDITIONS

● Function

This command is used to check the RF communications conditions that are set in the Reader/Writer.

● Command Area

Signal/data	Data type	Size	Function
CmdCode/Command Code	WORD	2 bytes	3002 hex
CmdParam1/Command Parameter 1	WORD	2 bytes	0000 hex (Not used.)
CmdParam2/Command Parameter 2	WORD	2 bytes	0000 hex (Not used.)
Reserved/Reserved Area	WORD	2 bytes	0000 hex (Not used.)
Cnt Response/Update Counter Response	WORD	2 bytes	0000 hex (At command execution) The value is counted up due to a change in the update counter. For details, refer to <i>Update Counter/Update Counter Response</i> on page 7-10.

● Response Area

Signal/data	Data type	Size	Function
ErrCode/Error Code	WORD	2 bytes	Error code
RespInfo1/Response Information 1	WORD	2 bytes	0000 hex (Not used.)
RespInfo2/Response Information 2	WORD	2 bytes	0000 hex (Not used.)
RespInfo3/Response Information 3	WORD	2 bytes	0000 hex (Not used.)
Cnt/Update Counter	WORD	2 bytes	0000 to FFFF hex The value is counted up due to a change in the response area. For details, refer to <i>Update Counter/Update Counter Response</i> on page 7-10.

RespData/Response Data

RF communication mode	WORD	2 bytes	Expresses the communications mode. 0000 hex: Once 0001 hex: Auto 0002 hex: Focus 0003 hex: Repeat Default setting: 0000 hex
Communications Speed	WORD	2 bytes	Expresses the communications speed. 0000 hex: Auto 0001 hex: High speed 0002 hex: Normal speed Default setting: 0000 hex
RF communication timeout time	WORD	2 bytes	Expresses the RF communications timeout time. 0001 hex to EA60 hex (1 to 60,000 [msec]) Default setting: 00FA hex (250 msec)
Write Verification	WORD	2 bytes	Expresses whether to perform write verification. 0000 hex: Do not verify. 0001 hex: Verify Default setting: 0001 hex
Communications Diagnostics	WORD	2 bytes	Expresses whether to perform communications diagnostics. 0000 hex: Do not verify. 0001 hex: Verify Default setting: 0000 hex

SET TRANSMISSION POWER

● Function

This command sets the transmission powers of the Reader/Writer.

● Command Area

Signal/data	Data type	Size	Function	
CmdCode/Command Code	WORD	2 bytes	3003 hex	
CmdParam1/Command Parameter 1	WORD	2 bytes	Number of words in transmission power settings 0002 to 0010 hex * Number of Readers/Writers x 2 words	
CmdParam2/Command Parameter 2	WORD	2 bytes	0000 hex (Not used.)	
Reserved/Reserved Area	WORD	2 bytes	0000 hex (Not used.)	
Cnt Response/Update Counter Response	WORD	2 bytes	0000 hex (At command execution) The value is counted up due to a change in the update counter. For details, refer to <i>Update Counter/Update Counter Response</i> on page 7-10.	
CmdData/Command Data				
Master Reader/Writer	Transmission power (Read)	WORD	2 bytes	Specifies the transmission power for read RF communications commands. 000F to 001B hex (15 to 27 dBm) Default setting: 001B hex
	Transmission power (Write)	WORD	2 bytes	Specifies the transmission power for write RF communications commands. 000F to 001B hex (15 to 27 dBm) Default setting: 001B hex
Slave Reader/Writer 1	Transmission power (Read)	WORD	2 bytes	Specifies the transmission power for read RF communications commands. 000F to 001B hex (15 to 27 dBm) Default setting: 001B hex
	Transmission power (Write)	WORD	2 bytes	Specifies the transmission power for write RF communications commands. 000F to 001B hex (15 to 27 dBm) Default setting: 001B hex
...	
Slave Reader/Writer 7	Transmission power (Read)	WORD	2 bytes	Specifies the transmission power for read RF communications commands. 000F to 001B hex (15 to 27 dBm) Default setting: 001B hex
	Transmission power (Write)	WORD	2 bytes	Specifies the transmission power for write RF communications commands. 000F to 001B hex (15 to 27 dBm) Default setting: 001B hex

● Response Area

Signal/data	Data type	Size	Function
ErrCode/Command Code	WORD	2 bytes	Error code
RespInfo1/Response Information 1	WORD	2 bytes	0000 hex (Not used.)
RespInfo2/Response Information 2	WORD	2 bytes	0000 hex (Not used.)
RespInfo3/Response Information 3	WORD	2 bytes	0000 hex (Not used.)
Cnt/Update Counter	WORD	2 bytes	0000 to FFFF hex The value is counted up due to a change in the response area. For details, refer to <i>Update Counter/Update Counter Response</i> on page 7-10.

GET TRANSMISSION POWER

● Function

This command is used to check the transmission powers that are set in the Reader/Writer.

● Command Area

Signal/data	Data type	Size	Function
CmdCode/Command Code	WORD	2 bytes	3004 hex
CmdParam1/Command Parameter 1	WORD	2 bytes	Number of words in transmission power settings 0002 to 0010 hex * Number of Readers/Writers x 2 words
CmdParam2/Command Parameter 2	WORD	2 bytes	0000 hex (Not used.)
Reserved/Reserved Area	WORD	2 bytes	0000 hex (Not used.)
Cnt Response/Update Counter Response	WORD	2 bytes	0000 hex (At command execution) The value is counted up due to a change in the update counter. For details, refer to <i>Update Counter/Update Counter Response</i> on page 7-10.

● Response Area

Signal/data	Data type	Size	Function
ErrCode/Error Code	WORD	2 bytes	Error code
RespInfo1/Response Information 1	WORD	2 bytes	0000 hex (Not used.)
RespInfo1/Response Information 2	WORD	2 bytes	0000 hex (Not used.)
RespInfo1/Response Information 3	WORD	2 bytes	0000 hex (Not used.)
Cnt/Update Counter	WORD	2 bytes	0000 to FFFF hex The value is counted up due to a change in the response area. For details, refer to <i>Update Counter/Update Counter Response</i> on page 7-10.

RespData/Response Data

Master Reader/Writer	Transmission power (Read)	WORD	2 bytes	Expresses the transmission power for read RF communications commands. 000F to 001B hex (15 to 27 dBm) Default setting: 001B hex
	Transmission power (Write)	WORD	2 bytes	Expresses the transmission power for write RF communications commands. 000F to 001B hex (15 to 27 dBm) Default setting: 001B hex
Slave Reader/Writer 1	Transmission power (Read)	WORD	2 bytes	Expresses the transmission power for read RF communications commands. 000F to 001B hex (15 to 27 dBm) Default setting: 001B hex
	Transmission power (Write)	WORD	2 bytes	Expresses the transmission power for write RF communications commands. 000F to 001B hex (15 to 27 dBm) Default setting: 001B hex
...

Signal/data		Data type	Size	Function
Slave Reader/Writer 7	Transmission power (Read)	WORD	2 bytes	Expresses the transmission power for read RF communications commands. 000F to 001B hex (15 to 27 dBm) Default setting: 001B hex
	Transmission power (Write)	WORD	2 bytes	Expresses the transmission power for write RF communications commands. 000F to 001B hex (15 to 27 dBm) Default setting: 001B hex

SET CHANNEL

● Function

This command sets the channels for the Reader/Writer.

● Command Area

Signal/data	Data type	Size	Function
CmdCode/Command Code	WORD	2 bytes	3005 hex
CmdParam1/Command Parameter 1	WORD	2 bytes	0000 hex (Not used.)
CmdParam2/Command Parameter 2	WORD	2 bytes	0000 hex (Not used.)
Reserved/Reserved Area	WORD	2 bytes	0000 hex (Not used.)
Cnt Response/Update Counter Response	WORD	2 bytes	0000 hex (At command execution) The value is counted up due to a change in the update counter. For details, refer to <i>Update Counter/Update Counter Response</i> on page 7-10.
CmdData/Command Data			
Channel	WORD	2 bytes	Specifies the channel.*1 [V780-HMD68-EIP-JP] 0000 hex: Auto 0005 hex: 5 CH 000B hex: 11 CH 0011 hex: 17 CH [V780-HMD68-EIP-IN] 0000 hex: Auto 0004 hex: 4 CH 0007 hex: 7 CH 000A hex: 10 CH [V780-HMD68-EIP-EU] 0000 hex: Auto 0004 hex: 4 CH 0007 hex: 7 CH 000A hex: 10 CH 000D hex: 13 CH [V780-HMD68-EIP-RU] 0000 hex: Auto 0007 hex: 7 CH 000A hex: 10 CH 000D hex: 13 CH

*1. You can set the channels to use only in the models for V780-HMD68-EIP-JP/-IN/-EU/-RU. You cannot set the channels for any other model.

● Response Area

Signal/data	Data type	Size	Function
ErrCode/Command Code	WORD	2 bytes	Error code
RespInfo1/Response Information 1	WORD	2 bytes	0000 hex (Not used.)
RespInfo2/Response Information 2	WORD	2 bytes	0000 hex (Not used.)
RespInfo3/Response Information 3	WORD	2 bytes	0000 hex (Not used.)
Cnt/Update Counter	WORD	2 bytes	0000 to FFFF hex The value is counted up due to a change in the response area. For details, refer to <i>Update Counter/Update Counter Response</i> on page 7-10.

GET CHANNEL

● Function

This command is used to check the channel settings that are set in the Reader/Writer.

● Command Area

Signal/data	Data type	Size	Function
CmdCode/Command Code	WORD	2 bytes	3006 hex
CmdParam1/Command Parameter 1	WORD	2 bytes	0000 hex (Not used.)
CmdParam2/Command Parameter 2	WORD	2 bytes	0000 hex (Not used.)
Reserved/Reserved Area	WORD	2 bytes	0000 hex (Not used.)
Cnt Response/Update Counter Response	WORD	2 bytes	0000 hex (At command execution) The value is counted up due to a change in the update counter. For details, refer to <i>Update Counter/Update Counter Response</i> on page 7-10.

● Response Area

Signal/data	Data type	Size	Function
ErrCode/Error Code	WORD	2 bytes	Error code
RespInfo1/Response Information 1	WORD	2 bytes	0000 hex (Not used.)
RespInfo2/Response Information 2	WORD	2 bytes	0000 hex (Not used.)
RespInfo3/Response Information 3	WORD	2 bytes	0000 hex (Not used.)
Cnt/Update Counter	WORD	2 bytes	0000 to FFFF hex The value is counted up due to a change in the response area. For details, refer to <i>Update Counter/Update Counter Response</i> on page 7-10.

RespData/Response Data

Signal/data	Data type	Size	Function
Channel	WORD	2 bytes	Expresses the channel.*1 [V780-HMD68-EIP-JP] 0000 hex: Auto 0005 hex: 5 CH 000B hex: 11 CH 0011 hex: 17 CH [V780-HMD68-EIP-IN] 0000 hex: Auto 0004 hex: 4 CH 0007 hex: 7 CH 000A hex: 10 CH [V780-HMD68-EIP-EU] 0000 hex: Auto 0004 hex: 4 CH 0007 hex: 7 CH 000A hex: 10 CH 000D hex: 13 CH [V780-HMD68-EIP-RU] 0000 hex: Auto 0007 hex: 7 CH 000A hex: 10 CH 000D hex: 13 CH

*1. Fixed channels can be acquired only in the models for V780-HMD68-EIP-JP/-IN/-EU/-RU. In the other models, the channels are fixed automatically.

SET GEN2 SESSION

● Function

This command sets the Gen2 session for the Reader/Writer.

● Command Area

Signal/data	Data type	Size	Function
CmdCode/Command Code	WORD	2 bytes	3007 hex
CmdParam1/Command Parameter 1	WORD	2 bytes	0000 hex (Not used.)
CmdParam2/Command Parameter 2	WORD	2 bytes	0000 hex (Not used.)
Reserved/Reserved Area	WORD	2 bytes	0000 hex (Not used.)
Cnt Response/Update Counter Response	WORD	2 bytes	0000 hex (At command execution) The value is counted up due to a change in the update counter. For details, refer to <i>Update Counter/Update Counter Response</i> on page 7-10.
CmdData/Command Data			
Gen2 session	WORD	2 bytes	Specifies the session to use for RF Tag communications. 0000 hex: S0 flag 0001 hex: S1 flag 0002 hex: S2 flag 0003 hex: S3 flag Default setting: 0000 hex

● Response Area

Signal/data	Data type	Size	Function
ErrCode/Command Code	WORD	2 bytes	Error code
RespInfo1/Response Information 1	WORD	2 bytes	0000 hex (Not used.)
RespInfo2/Response Information 2	WORD	2 bytes	0000 hex (Not used.)
RespInfo3/Response Information 3	WORD	2 bytes	0000 hex (Not used.)
Cnt/Update Counter	WORD	2 bytes	0000 to FFFF hex The value is counted up due to a change in the response area. For details, refer to <i>Update Counter/Update Counter Response</i> on page 7-10.

GET GEN2 SESSION

● Function

This command is used to check the Gen2 session that is set in the Reader/Writer.

● Command Area

Signal/data	Data type	Size	Function
CmdCode/Command Code	WORD	2 bytes	3008 hex
CmdParam1/Command Parameter 1	WORD	2 bytes	0000 hex (Not used.)
CmdParam2/Command Parameter 2	WORD	2 bytes	0000 hex (Not used.)
Reserved/Reserved Area	WORD	2 bytes	0000 hex (Not used.)
Cnt Response/Update Counter Response	WORD	2 bytes	0000 hex (At command execution) The value is counted up due to a change in the update counter. For details, refer to <i>Update Counter/Update Counter Response</i> on page 7-10.

● Response Area

Signal/data	Data type	Size	Function
ErrCode/Error Code	WORD	2 bytes	Error code
RespInfo1/Response Information 1	WORD	2 bytes	0000 hex (Not used.)
RespInfo2/Response Information 2	WORD	2 bytes	0000 hex (Not used.)
RespInfo3/Response Information 3	WORD	2 bytes	0000 hex (Not used.)
Cnt/Update Counter	WORD	2 bytes	0000 to FFFF hex The value is counted up due to a change in the response area. For details, refer to <i>Update Counter/Update Counter Response</i> on page 7-10.
RespData/Response Data			
Gen2 session	WORD	2 bytes	Expresses the session to use for RF Tag communications. 0000 hex: S0 flag 0001 hex: S1 flag 0002 hex: S2 flag 0003 hex: S3 flag Default setting: 0000 hex

SET ACCESS PASSWORD

● Function

This command sets the access password for RF Tag communications of the Reader/Writer.

● Command Area

Signal/data	Data type	Size	Function
CmdCode/Command Code	WORD	2 bytes	3009 hex
CmdParam1/Command Parameter 1	WORD	2 bytes	0000 hex (Not used.)
CmdParam2/Command Parameter 2	WORD	2 bytes	0000 hex (Not used.)
Reserved/Reserved Area	WORD	2 bytes	0000 hex (Not used.)
Cnt Response/Update Counter Response	WORD	2 bytes	0000 hex (At command execution) The value is counted up due to a change in the update counter. For details, refer to <i>Update Counter/Update Counter Response</i> on page 7-10.
CmdData/Command Data			
Access password	DWORD	4 bytes	Specifies the access password to use for RF Tag communications. The specified access password is stored in EEPROM memory in the Reader/Writer. If the access password in the RF Tag is not all zeros, the access password that is stored in EEPROM memory must be used to execute LOCK, ID WRITE, DATA READ, or DATA WRITE commands. Default setting: 00000000 hex

● Response Area

Signal/data	Data type	Size	Function
ErrCode/Command Code	WORD	2 bytes	Error code
RespInfo1/Response Information 1	WORD	2 bytes	0000 hex (Not used.)
RespInfo2/Response Information 2	WORD	2 bytes	0000 hex (Not used.)
RespInfo3/Response Information 3	WORD	2 bytes	0000 hex (Not used.)
Cnt/Update Counter	WORD	2 bytes	0000 to FFFF hex The value is counted up due to a change in the response area. For details, refer to <i>Update Counter/Update Counter Response</i> on page 7-10.

GET ACCESS PASSWORD

● Function

This command reads the access password that is set for RF Tag communications in the Reader/Writer.

● Command Area

Signal/data	Data type	Size	Function
CmdCode/Command Code	WORD	2 bytes	300A hex
CmdParam1/Command Parameter 1	WORD	2 bytes	0000 hex (Not used.)
CmdParam2/Command Parameter 2	WORD	2 bytes	0000 hex (Not used.)
Reserved/Reserved Area	WORD	2 bytes	0000 hex (Not used.)
Cnt Response/Update Counter Response	WORD	2 bytes	0000 hex (At command execution) The value is counted up due to a change in the update counter. For details, refer to <i>Update Counter/Update Counter Response</i> on page 7-10.

● Response Area

Signal/data	Data type	Size	Function
ErrCode/Error Code	WORD	2 bytes	Error code
RespInfo1/Response Information 1	WORD	2 bytes	0000 hex (Not used.)
RespInfo2/Response Information 2	WORD	2 bytes	0000 hex (Not used.)
RespInfo3/Response Information 3	WORD	2 bytes	0000 hex (Not used.)
Cnt/Update Counter	WORD	2 bytes	0000 to FFFF hex The value is counted up due to a change in the response area. For details, refer to <i>Update Counter/Update Counter Response</i> on page 7-10.

RespData/Response Data

Access password	DWORD	4 bytes	Expresses the access password to use for RF Tag communications. If the access password in the RF Tag is not all zeros, the access password that is stored in EEPROM memory must be used to execute LOCK, ID WRITE, DATA READ, or DATA WRITE commands. Default setting: 00000000 hex
-----------------	-------	---------	---

SET RF TAG SELECTION FILTER CONDITIONS

● Function

This command sets the RF Tag selection filter conditions for the Reader/Writer.

● Command Area

Signal/data	Data type	Size	Function
CmdCode/Command Code	WORD	2 bytes	300B hex
CmdParam1/Command Parameter 1	WORD	2 bytes	0000 hex (Not used.)
CmdParam2/Command Parameter 2	WORD	2 bytes	0000 hex (Not used.)
Reserved/Reserved Area	WORD	2 bytes	0000 hex (Not used.)
Cnt Response/Update Counter Response	WORD	2 bytes	0000 hex (At command execution) The value is counted up due to a change in the update counter. For details, refer to <i>Update Counter/Update Counter Response</i> on page 7-10.

CmdData/Command Data

RF Tag selection filter conditions	Enable/dis-able	WORD	2 bytes	Specifies whether to enable or disable RF Tag selection filter conditions. 0000 hex: Disable 0001 hex: Enable Default setting: 0000 hex
	Address ^{*1}	WORD	2 bytes	Specifies the address (in words) of the RF Tag to check. 1000 to 17FF hex: UII (EPC) area ^{*2} 2000 to 27FF hex: TID area 3000 to 3FFF hex: User area * You cannot specify 0000 to 07FF hex (reserved area). Default setting: 0000 hex
	Data length ^{*1}	WORD	2 bytes	Specifies the number of words of data to check. Setting range: 0000 to 0010 hex Default setting: 0000 hex
	Data ^{*1}	ARRAY[] OF WORD	16 words (32 bytes)	Specifies the data to check. (16 words) * Fill unused data with 0000 hex. * In compliance with Gen2 standards, bits 0 to 255 are masked, so the last bit of word 16 (bit 256) is ignored. Default setting: 00..00 hex

*1. If the RF Tag selection filter conditions settings are disabled, this value is always 0000 hex.

*2. Address 1000 hex specifies the "UII (EPC)_CRC-16" area of the RF Tag. Since this area varies depending on the EPC code, care must be taken during use.

● Response Area

Signal/data	Data type	Size	Function
ErrCode/Command Code	WORD	2 bytes	Error code
RespInfo1/Response Information 1	WORD	2 bytes	0000 hex (Not used.)
RespInfo2/Response Information 2	WORD	2 bytes	0000 hex (Not used.)
RespInfo3/Response Information 3	WORD	2 bytes	0000 hex (Not used.)
Cnt/Update Counter	WORD	2 bytes	0000 to FFFF hex The value is counted up due to a change in the response area. For details, refer to <i>Update Counter/Update Counter Response</i> on page 7-10.

GET RF TAG SELECTION FILTER CONDITIONS

● Function

This command reads the RF Tag selection filter conditions that are set in the Reader/Writer.

● Command Area

Signal/data	Data type	Size	Function
CmdCode/Command Code	WORD	2 bytes	300C hex
CmdParam1/Command Parameter 1	WORD	2 bytes	0000 hex (Not used.)
CmdParam2/Command Parameter 2	WORD	2 bytes	0000 hex (Not used.)
Reserved/Reserved Area	WORD	2 bytes	0000 hex (Not used.)
Cnt Response/Update Counter Response	WORD	2 bytes	0000 hex (At command execution) The value is counted up due to a change in the update counter. For details, refer to <i>Update Counter/Update Counter Response</i> on page 7-10.

● Response Area

Signal/data	Data type	Size	Function
ErrCode/Error Code	WORD	2 bytes	Error code
RespInfo1/Response Information 1	WORD	2 bytes	0000 hex (Not used.)
RespInfo1/Response Information 2	WORD	2 bytes	0000 hex (Not used.)
RespInfo1/Response Information 3	WORD	2 bytes	0000 hex (Not used.)
Cnt/Update Counter	WORD	2 bytes	0000 to FFFF hex The value is counted up due to a change in the response area. For details, refer to <i>Update Counter/Update Counter Response</i> on page 7-10.

RespData/Response Data

RF Tag selection filter conditions	Enable/disable	WORD	2 bytes	Expresses whether to enable or disable RF Tag selection filter conditions. 0000 hex: Disable 0001 hex: Enable Default setting: 0000 hex
	Address ^{*1}	WORD	2 bytes	Expresses the address (in words) of the RF Tag to check. 1000 to 17FF hex: UII (EPC) area 2000 to 27FF hex: TID area 3000 to 3FFF hex: User area Default setting: 0000 hex
	Data length ^{*1}	WORD	2 bytes	Expresses the number of words of the data to check. Default setting: 0000 hex
	Data ^{*1}	ARRAY[] OF WORD	16 words (32 bytes)	Gives the data to check for. (16 words) * The unused data is filled with 0000 hex. Default setting: 00..00 hex

*1. If the RF Tag selection filter conditions settings are disabled, this value is always 0000 hex.

SET RSSI FILTER CONDITIONS

● Function

This command sets the RSSI filter conditions for the Reader/Writer.

● Command Area

Signal/data	Data type	Size	Function	
CmdCode/Command Code	WORD	2 bytes	300D hex	
CmdParam1/Command Parameter 1	WORD	2 bytes	0000 hex (Not used.)	
CmdParam2/Command Parameter 2	WORD	2 bytes	0000 hex (Not used.)	
Reserved/Reserved Area	WORD	2 bytes	0000 hex (Not used.)	
Cnt Response/Update Counter Response	WORD	2 bytes	0000 hex (At command execution) The value is counted up due to a change in the update counter. For details, refer to <i>Update Counter/Update Counter Response</i> on page 7-10.	
CmdData/Command Data				
RSSI filter conditions	Enable/dis-able	WORD	2 bytes	Specifies the enable/disable setting of the RSSI filter. 0000 hex: Disable 0001 hex: Enable Default setting: 0000 hex
	HIGH Threshold* ¹	WORD	2 bytes	Specifies the high threshold for the reception level. FFBA to FFF6 hex (0 or -70 to -10) [dBm] Default setting: 0000 hex
	LOW Threshold* ¹	WORD	2 bytes	Specifies the low threshold for the reception level. FFBA to FFF6 hex (0 or -70 to -10) [dBm] Default setting: 0000 hex

*1. When you disable the RSSI filter conditions, set the high and low thresholds to 0000 hex.

When you enable the RSSI filter, set the high threshold value for the RSSI filter condition to a higher value than the low threshold level. Otherwise, a command parameter error will occur.

● Response Area

Signal/data	Data type	Size	Function
ErrCode/Command Code	WORD	2 bytes	Error code
RespInfo1/Response Information 1	WORD	2 bytes	0000 hex (Not used.)
RespInfo2/Response Information 2	WORD	2 bytes	0000 hex (Not used.)
RespInfo3/Response Information 3	WORD	2 bytes	0000 hex (Not used.)
Cnt/Update Counter	WORD	2 bytes	0000 to FFFF hex The value is counted up due to a change in the response area. For details, refer to <i>Update Counter/Update Counter Response</i> on page 7-10.

GET RSSI FILTER CONDITIONS

● Function

This command is used to check the RSSI filter conditions that are set in the Reader/Writer.

● Command Area

Signal/data	Data type	Size	Function
CmdCode/Command Code	WORD	2 bytes	300E hex
CmdParam1/Command Parameter 1	WORD	2 bytes	0000 hex (Not used.)
CmdParam2/Command Parameter 2	WORD	2 bytes	0000 hex (Not used.)
Reserved/Reserved Area	WORD	2 bytes	0000 hex (Not used.)
Cnt Response/Update Counter Response	WORD	2 bytes	0000 hex (At command execution) The value is counted up due to a change in the update counter. For details, refer to <i>Update Counter/Update Counter Response</i> on page 7-10.

● Response Area

Signal/data	Data type	Size	Function
ErrCode/Error Code	WORD	2 bytes	Error code
RespInfo1/Response Information 1	WORD	2 bytes	0000 hex (Not used.)
RespInfo1/Response Information 2	WORD	2 bytes	0000 hex (Not used.)
RespInfo1/Response Information 3	WORD	2 bytes	0000 hex (Not used.)
Cnt/Update Counter	WORD	2 bytes	0000 to FFFF hex The value is counted up due to a change in the response area. For details, refer to <i>Update Counter/Update Counter Response</i> on page 7-10.

RespData/Response Data

RSSI filter conditions	Enable/dis-able	WORD	2 bytes	Expresses whether the RSSI filter is enabled or disabled. 0000 hex: Disable 0001 hex: Enable Default setting: 0000 hex
	HIGH Threshold* ¹	WORD	2 bytes	Expresses the high threshold for the reception level. FFBA to FFF6 hex (0 or -70 to -10) [dBm] Default setting: 0000 hex
	LOW Threshold* ¹	WORD	2 bytes	Expresses the low threshold for the reception level. FFBA to FFF6 hex (0 or -70 to -10) [dBm] Default setting: 0000 hex

*1. If the RF Tag selection filter conditions settings are disabled, this value is always 0000 hex.

SET TRANSMISSION TIME

● Function

This command sets the time to stop the transmission power.

● Command Area

Signal/data	Data type	Size	Function
CmdCode/Command Code	WORD	2 bytes	300F hex
CmdParam1/Command Parameter 1	WORD	2 bytes	0000 hex (Not used.)
CmdParam2/Command Parameter 2	WORD	2 bytes	0000 hex (Not used.)
Reserved/Reserved Area	WORD	2 bytes	0000 hex (Not used.)
Cnt Response/Update Counter Response	WORD	2 bytes	0000 hex (At command execution) The value is counted up due to a change in the update counter. For details, refer to <i>Update Counter/Update Counter Response</i> on page 7-10.
CmdData/Command Data			
Stop time ^{*1}	WORD	2 bytes	Specifies the time to pause output during transmission command execution. [V780-HMD68-EIP-JP] 0000 hex, 000A to 03E8 hex (0000 hex is either None, or 10 to 1,000) [msec] Default setting: 0000 hex [V780-HMD68-EIP-KR/-CN/-TW/-ID/-MY/-SG/-US/-MX] 000A to 03E8 hex (10 to 1,000 [msec]) Default setting: 000A hex [V780-HMD68-EIP-IN/-EU/-RU] 0064 to 03E8 hex (100 to 1,000 [msec]) Default setting: 0064 hex
Continuous transmission time	WORD	2 bytes	Specifies the maximum time to continuously output radio waves during communications command execution. [V780-HMD68-EIP-JP] ^{*1} 0000 hex, 0190 to 2710 hex (0000 hex is either No limit, or 400 to 10,000) [msec] Default setting: 0000 hex [Models other than V780-HMD68-EIP-JP] Always 0000 hex

*1. To specify the stop time in the V780-HMD68-EIP-JP, be sure to specify the continuous transmission time to other than infinite (0000 hex). A command parameter error will occur if only either one of stop time or continuous transmission time is set to 0.

The stop time cannot be set to 0000 hex in models other than those for V780-HMD68-EIP-JP.

● Response Area

Signal/data	Data type	Size	Function
ErrCode/Command Code	WORD	2 bytes	Error code
RespInfo1/Response Information 1	WORD	2 bytes	0000 hex (Not used.)
RespInfo2/Response Information 2	WORD	2 bytes	0000 hex (Not used.)
RespInfo3/Response Information 3	WORD	2 bytes	0000 hex (Not used.)
Cnt/Update Counter	WORD	2 bytes	0000 to FFFF hex The value is counted up due to a change in the response area. For details, refer to <i>Update Counter/Update Counter Response</i> on page 7-10.

GET TRANSMISSION TIME

● Function

This command is used to check the transmission times that are set in the Reader/Writer.

● Command Area

Signal/data	Data type	Size	Function
CmdCode/Command Code	WORD	2 bytes	3010 hex
CmdParam1/Command Parameter 1	WORD	2 bytes	0000 hex (Not used.)
CmdParam2/Command Parameter 2	WORD	2 bytes	0000 hex (Not used.)
Reserved/Reserved Area	WORD	2 bytes	0000 hex (Not used.)
Cnt Response/Update Counter Response	WORD	2 bytes	0000 hex (At command execution) The value is counted up due to a change in the update counter. For details, refer to <i>Update Counter/Update Counter Response</i> on page 7-10.

● Response Area

Signal/data	Data type	Size	Function
ErrCode/Error Code	WORD	2 bytes	Error code
ResplInfo1/Response Information 1	WORD	2 bytes	0000 hex (Not used.)
ResplInfo2/Response Information 2	WORD	2 bytes	0000 hex (Not used.)
ResplInfo3/Response Information 3	WORD	2 bytes	0000 hex (Not used.)
Cnt/Update Counter	WORD	2 bytes	0000 to FFFF hex The value is counted up due to a change in the response area. For details, refer to <i>Update Counter/Update Counter Response</i> on page 7-10.

RespData/Response Data

Stop time ^{*1}	WORD	2 bytes	Expresses the time to pause output during transmission command execution. [V780-HMD68-EIP-JP] 0000 hex, 000A to 03E8 hex (0000 hex is either None, or 10 to 1,000) [msec] Default setting: 0000 hex [V780-HMD68-EIP-KR/-CN/-TW/-ID/-MY/-SG/-US/-MX] 000A to 03E8 hex (10 to 1,000 [msec]) Default setting: 000A hex [V780-HMD68-EIP-IN/-EU/-RU] 0064 to 03E8 hex (100 to 1,000 [msec]) Default setting: 0064 hex
-------------------------	------	---------	---

Signal/data	Data type	Size	Function
Continuous transmission time	WORD	2 bytes	<p>Expresses the maximum time to continuously output radio waves during communications command execution.</p> <p>[V780-HMD68-EIP-JP]^{*1} 0000 hex, 0190 to 2710 hex (0000 hex is either No limit, or 400 to 10,000) [msec] Default setting: 0000 hex</p> <p>[Models other than V780-HMD68-EIP-JP] Always 0000 hex</p>

SET SMOOTHING BUFFER

● Function

This command sets the smoothing buffer size of the Reader/Writer.

● Command Area

Signal/name	Data type	Size	Function
CmdCode/Command Code	WORD	2 bytes	3011 hex
CmdParam1/Command Parameter 1	WORD	2 bytes	0000 hex (Not used.)
CmdParam2/Command Parameter 2	WORD	2 bytes	0000 hex (Not used.)
Reserved/Reserved Area	WORD	2 bytes	0000 hex (Not used.)
Cnt Response/Update Counter Response	WORD	2 bytes	0000 hex (At command execution) The value is counted up due to a change in the update counter. For details, refer to <i>Update Counter/Update Counter Response</i> on page 7-10.
CmdData/Command Data			
Smoothing Buffer Size	WORD	2 bytes	Specifies the smoothing buffer size. 0000 to 0400 hex (0 to 1024 [conditions]) * 0 implies that smoothing is disabled Default setting: 0400 hex

● Response Area

Signal/data	Data type	Size	Function
ErrCode/Command Code	WORD	2 bytes	Error code
RespInfo1/Response Information 1	WORD	2 bytes	0000 hex (Not used.)
RespInfo2/Response Information 2	WORD	2 bytes	0000 hex (Not used.)
RespInfo3/Response Information 3	WORD	2 bytes	0000 hex (Not used.)
Cnt/Update Counter	WORD	2 bytes	0000 to FFFF hex The value is counted up due to a change in the response area. For details, refer to <i>Update Counter/Update Counter Response</i> on page 7-10.

GET SMOOTHING BUFFER

● Function

This command gets the smoothing buffer size of the Reader/Writer.

● Command Area

Signal/data	Data type	Size	Function
CmdCode/Command Code	WORD	2 bytes	3012 hex
CmdParam1/Command Parameter 1	WORD	2 bytes	0000 hex (Not used.)
CmdParam2/Command Parameter 2	WORD	2 bytes	0000 hex (Not used.)
Reserved/Reserved Area	WORD	2 bytes	0000 hex (Not used.)
Cnt Response/Update Counter Response	WORD	2 bytes	0000 hex (At command execution) The value is counted up due to a change in the update counter. For details, refer to <i>Update Counter/Update Counter Response</i> on page 7-10.

● Response Area

Signal/data	Data type	Size	Function
ErrCode/Error Code	WORD	2 bytes	Error code
RespInfo1/Response Information 1	WORD	2 bytes	0000 hex (Not used.)
RespInfo2/Response Information 2	WORD	2 bytes	0000 hex (Not used.)
RespInfo3/Response Information 3	WORD	2 bytes	0000 hex (Not used.)
Cnt/Update Counter	WORD	2 bytes	0000 to FFFF hex The value is counted up due to a change in the response area. For details, refer to <i>Update Counter/Update Counter Response</i> on page 7-10.
RespData/Response Data			
Smoothing Buffer Size	WORD	2 bytes	Expresses the smoothing buffer size. 0000 to 0400 hex (0 to 1024 [conditions]) * 0 implies that smoothing is disabled Default setting: 0400 hex

7-2-7 Maintenance Commands: Device Information

GET MODEL INFORMATION

● Function

This command reads the model of the Reader/Writer.

● Command Area

Signal/data	Data type	Size	Function
CmdCode/Command Code	WORD	2 bytes	4001 hex
CmdParam1/Command Parameter 1	WORD	2 bytes	0000 hex (Not used.)
CmdParam2/Command Parameter 2	WORD	2 bytes	0000 hex (Not used.)
Reserved/Reserved Area	WORD	2 bytes	0000 hex (Not used.)
Cnt Response/Update Counter Response	WORD	2 bytes	0000 hex (At command execution) The value is counted up due to a change in the update counter. For details, refer to <i>Update Counter/Update Counter Response</i> on page 7-10.

● Response Area

Signal/data	Data type	Size	Function
ErrCode/Error Code	WORD	2 bytes	Error code
RespInfo1/Response Information 1	WORD	2 bytes	0000 hex (Not used.)
RespInfo2/Response Information 2	WORD	2 bytes	0000 hex (Not used.)
RespInfo3/Response Information 3	WORD	2 bytes	0000 hex (Not used.)
Cnt/Update Counter	WORD	2 bytes	0000 to FFFF hex The value is counted up due to a change in the response area. For details, refer to <i>Update Counter/Update Counter Response</i> on page 7-10.

RespData/Response Data

RespData/Response Data	ARRAY[] OF BYTE	32 bytes	Expresses the model information that was read with up to 32 bytes of ASCII characters (up to 31 ASCII characters plus the end code (00 hex)). If there are fewer than 31 characters, the remaining bytes are filled with 00 hex. The response data is expressed by ASCII characters 20 hex (space) to 7E hex ("). Default setting: 00..00 hex
------------------------	--------------------	----------	--

GET FIRMWARE VERSION

● Function

This command reads the firmware version of the Reader/Writer.

● Command Area

Signal/data	Data type	Size	Function
CmdCode/Command Code	WORD	2 bytes	4002 hex
CmdParam1/Command Parameter 1	WORD	2 bytes	0000 hex (Not used.)
CmdParam2/Command Parameter 2	WORD	2 bytes	0000 hex (Not used.)
Reserved/Reserved Area	WORD	2 bytes	0000 hex (Not used.)
Cnt Response/Update Counter Response	WORD	2 bytes	0000 hex (At command execution) The value is counted up due to a change in the update counter. For details, refer to <i>Update Counter/Update Counter Response</i> on page 7-10.

● Response Area

Signal/data	Data type	Size	Function
ErrCode/Error Code	WORD	2 bytes	Error code
RespInfo1/Response Information 1	WORD	2 bytes	0000 hex (Not used.)
RespInfo1/Response Information 2	WORD	2 bytes	0000 hex (Not used.)
RespInfo1/Response Information 3	WORD	2 bytes	0000 hex (Not used.)
Cnt/Update Counter	WORD	2 bytes	0000 to FFFF hex The value is counted up due to a change in the response area. For details, refer to <i>Update Counter/Update Counter Response</i> on page 7-10.

RespData/Response Data

Firmware version	Run mode program major version	WORD	2 bytes	0000 to 0099 hex (BCD)
	Run mode program minor version	WORD	2 bytes	1000 to 0099 hex (BCD)
	Run mode program revision	WORD	2 bytes	0000 to 9999 hex (BCD)
	Safe mode program major version	WORD	2 bytes	0000 to 0099 hex (BCD)
	Safe mode program minor version	WORD	2 bytes	0000 to 0099 hex (BCD)
	Safe mode program revision	WORD	2 bytes	0000 to 9999 hex (BCD)

SET TIME INFORMATION

● Function

This command sets the time information in the Reader/Writer.

When the Reader/Writer is restarted, the time information is reset. (All zeros will be set for the actual time flag, hour, minutes, and seconds.)

● Command Area

Signal/data	Data type	Size	Function	
CmdCode/Command Code	WORD	2 bytes	4005 hex	
CmdParam1/Command Parameter 1	WORD	2 bytes	0000 hex (Not used.)	
CmdParam2/Command Parameter 2	WORD	2 bytes	0000 hex (Not used.)	
Reserved/Reserved Area	WORD	2 bytes	0000 hex (Not used.)	
Cnt Response/Update Counter Response	WORD	2 bytes	0000 hex (At command execution) The value is counted up due to a change in the update counter. For details, refer to <i>Update Counter/Update Counter Response</i> on page 7-10.	
CmdData/Command Data				
Time information	Resv	BYTE	1 byte	Always 00 hex.
	Hour	BYTE	1 byte	Hour 0 to 23
	Minutes	BYTE	1 byte	Minutes 0 to 59
	Seconds	BYTE	1 byte	Seconds 0 to 59

● Response Area

Signal/data	Data type	Size	Function
ErrCode/Command Code	WORD	2 bytes	Error code
RespInfo1/Response Information 1	WORD	2 bytes	0000 hex (Not used.)
RespInfo2/Response Information 2	WORD	2 bytes	0000 hex (Not used.)
RespInfo3/Response Information 3	WORD	2 bytes	0000 hex (Not used.)
Cnt/Update Counter	WORD	2 bytes	0000 to FFFF hex The value is counted up due to a change in the response area. For details, refer to <i>Update Counter/Update Counter Response</i> on page 7-10.

GET TIME INFORMATION

● Function

This command is used to check the time information from the Reader/Writer.

● Command Area

Signal/data	Data type	Size	Function
CmdCode/Command Code	WORD	2 bytes	4006 hex
CmdParam1/Command Parameter 1	WORD	2 bytes	0000 hex (Not used.)
CmdParam2/Command Parameter 2	WORD	2 bytes	0000 hex (Not used.)
Reserved/Reserved Area	WORD	2 bytes	0000 hex (Not used.)
Cnt Response/Update Counter Response	WORD	2 bytes	0000 hex (At command execution) The value is counted up due to a change in the update counter. For details, refer to <i>Update Counter/Update Counter Response</i> on page 7-10.

● Response Area

Signal/data	Data type	Size	Function
ErrCode/Error Code	WORD	2 bytes	Error code
RespInfo1/Response Information 1	WORD	2 bytes	0000 hex (Not used.)
RespInfo1/Response Information 2	WORD	2 bytes	0000 hex (Not used.)
RespInfo1/Response Information 3	WORD	2 bytes	0000 hex (Not used.)
Cnt/Update Counter	WORD	2 bytes	0000 to FFFF hex The value is counted up due to a change in the response area. For details, refer to <i>Update Counter/Update Counter Response</i> on page 7-10.

RespData/Response Data

Time information	Actual time flag	BYTE	1 byte	This byte indicates whether the actual time was set from the host device. 0: The time has not been set, so the time information gives the running time since the power supply to the Reader/Writer was turned ON. 1: The time was set, so the time information is the drive time from the time set from the host device.
	Hour	BYTE	1 byte	Hour 0 to 23
	Minutes	BYTE	1 byte	Minutes 0 to 59
	Seconds	BYTE	1 byte	Seconds 0 to 59

7-2-8 Maintenance Commands: Log Information

GET SYSTEM ERROR LOG

● Function

This command is used to check the log of system errors that have occurred in the Reader/Writer. The system error log is retained even when the Reader/Writer is restarted.

● Command Area

Signal/data	Data type	Size	Function
CmdCode/Command Code	WORD	2 bytes	4101 hex
CmdParam1/Command Parameter 1	WORD	2 bytes	Start number of record to acquire (0 to 14)
CmdParam2/Command Parameter 2	WORD	2 bytes	Number of records to acquire (1 to 15)
Reserved/Reserved Area	WORD	2 bytes	0000 hex (Not used.)
Cnt Response/Update Counter Response	WORD	2 bytes	0000 hex (At command execution) The value is counted up due to a change in the update counter. For details, refer to <i>Update Counter/Update Counter Response</i> on page 7-10.

● Response Area

Signal/data	Data type	Size	Function
ErrCode/Error Code	WORD	2 bytes	Error code
RespInfo1/Response Information 1	WORD	2 bytes	0000 hex (Not used.)
RespInfo2/Response Information 2	WORD	2 bytes	0000 hex (Not used.)
RespInfo3/Response Information 3	WORD	2 bytes	0000 hex (Not used.)
Cnt/Update Counter	WORD	2 bytes	0000 to FFFF hex The value is counted up due to a change in the response area. For details, refer to <i>Update Counter/Update Counter Response</i> on page 7-10.

RespData/Response Data^{*1}

Newest record in system error log	Time information	ARRAY[] OF BYTE	4 bytes	Expresses the time information. (Actual time flag, hour, minutes, and seconds)
	Error code	WORD	2 bytes	Expresses the error code.
	Reserved	WORD	2 bytes	(Reserved.)
	Attached information 1	DWORD	4 bytes	Additional error information 1 (00 hex if there is no attached information)
	Attached information 2	DWORD	4 bytes	Additional error information 2 (00 hex if there is no attached information)
Newest record - 1 in system error log	---	---	---	---
...
Newest record - 14 in system error log	---	---	---	---

*1. The maximum number of system error logs that can be acquired differs according to the area size.

Response Area	Max. no.
Output_110	4
Output_111	15
Output_112	15
Output_113	15

CLEAR SYSTEM ERROR LOG

● Function

This command clears the log of system errors (fatal errors) that is stored in the Reader/Writer.

● Command Area

Signal/data	Data type	Size	Function
CmdCode/Command Code	WORD	2 bytes	4102 hex
CmdParam1/Command Parameter 1	WORD	2 bytes	0000 hex (Not used.)
CmdParam2/Command Parameter 2	WORD	2 bytes	0000 hex (Not used.)
Reserved/Reserved Area	WORD	2 bytes	0000 hex (Not used.)
Cnt Response/Update Counter Response	WORD	2 bytes	0000 hex (At command execution) The value is counted up due to a change in the update counter. For details, refer to <i>Update Counter/Update Counter Response</i> on page 7-10.

● Response Area

Signal/data	Data type	Size	Function
ErrCode/Command Code	WORD	2 bytes	Error code
RespInfo1/Response Information 1	WORD	2 bytes	0000 hex (Not used.)
RespInfo2/Response Information 2	WORD	2 bytes	0000 hex (Not used.)
RespInfo3/Response Information 3	WORD	2 bytes	0000 hex (Not used.)
Cnt/Update Counter	WORD	2 bytes	0000 to FFFF hex The value is counted up due to a change in the response area. For details, refer to <i>Update Counter/Update Counter Response</i> on page 7-10.

GET COMMAND ERROR LOG

● Function

This command is used to check the log of command errors that have occurred in the Reader/Writer. The command error log information is cleared when the Reader/Writer is restarted.

● Command Area

Signal/data	Data type	Size	Function
CmdCode/Command Code	WORD	2 bytes	4103 hex
CmdParam1/Command Parameter 1	WORD	2 bytes	Start number of record to acquire (0 to 7)
CmdParam2/Command Parameter 2	WORD	2 bytes	Number of records to acquire (1 to 8)
Reserved/Reserved Area	WORD	2 bytes	0000 hex (Not used.)
Cnt Response/Update Counter Response	WORD	2 bytes	0000 hex (At command execution) The value is counted up due to a change in the update counter. For details, refer to <i>Update Counter/Update Counter Response</i> on page 7-10.

● Response Area

Signal/data	Data type	Size	Function
ErrCode/Error Code	WORD	2 bytes	Error code
RespInfo1/Response Information 1	WORD	2 bytes	0000 hex (Not used.)
RespInfo2/Response Information 2	WORD	2 bytes	0000 hex (Not used.)
RespInfo3/Response Information 3	WORD	2 bytes	0000 hex (Not used.)
Cnt/Update Counter	WORD	2 bytes	0000 to FFFF hex The value is counted up due to a change in the response area. For details, refer to <i>Update Counter/Update Counter Response</i> on page 7-10.

RespData/Response Data^{*1}

Newest record in the command error log	Time information	ARRAY[] OF BYTE	4 bytes	Expresses the time information. (Actual time flag, hour, minutes, and seconds)
	IP address of the remote device	DWORD	4 bytes	Expresses the IP address of the remote device. Example: C0A801C8 hex (192.168.1.200)
	Resv	WORD	2 bytes	Always 0000 hex.
	Command code	WORD	2 bytes	Expresses the command code.
	Error code	WORD	2 bytes	Expresses the error code.
	Reader/Writer No.	WORD	2 bytes	Expresses the R/W no. of the Reader/Writer communicating with the RF Tag. * The value is 0000 hex when the multi-Reader/Writer mode is disabled, or in the case of a command error.
	Attached information 1	DWORD	4 bytes	Additional error information 1 (00 hex if there is no attached information)
Attached information 2	DWORD	4 bytes	Additional error information 2 (00 hex if there is no attached information)	
Newest record - 1 in the command error log	---	---	---	---
...
Newest record - 7 in the command error log	---	---	---	---

*1. The maximum number of system error logs that can be acquired differs according to the area size.

Response Area	Max. no.
Output_110	2
Output_111	8
Output_112	8
Output_113	8

7-2-9 Maintenance Commands: RF Communications Information

GET RF TAG ADDITIONAL INFORMATION

● Function

This command is used to check the attached information (i.e., the UII (EPC code), reception level, and Reader/Writer No.) that resulted from communications for a single-access command with the immediately preceding RF Tag.

If communications for the immediately preceding single-access command ended in an error, attached information of 00 hex will be returned.

● Command Area

Signal/data	Data type	Size	Function
CmdCode/Command Code	WORD	2 bytes	4201 hex
CmdParam1/Command Parameter 1	WORD	2 bytes	0000 hex (Not used.)
CmdParam2/Command Parameter 2	WORD	2 bytes	0000 hex (Not used.)
Reserved/Reserved Area	WORD	2 bytes	0000 hex (Not used.)
Cnt Response/Update Counter Response	WORD	2 bytes	0000 hex (At command execution) The value is counted up due to a change in the update counter. For details, refer to <i>Update Counter/Update Counter Response</i> on page 7-10.

● Response Area

Signal/data	Data type	Size	Function
ErrCode/Error Code	WORD	2 bytes	Error code
RespInfo1/Response Information 1	WORD	2 bytes	R/W no. of the Reader/Writer communicating with the RF Tag 0000 to 0007 hex
RespInfo2/Response Information 2	WORD	2 bytes	0000 hex (Not used.)
RespInfo3/Response Information 3	WORD	2 bytes	Reception level FFFF to FF9D hex (-1 to -99 [dBm])
Cnt/Update Counter	WORD	2 bytes	0000 to FFFF hex The value is counted up due to a change in the response area. For details, refer to <i>Update Counter/Update Counter Response</i> on page 7-10.
RespData/Response Data			
StoredPC	WORD	2 bytes	Expresses the StoredPC data. The upper 5 bits are the UII (EPC) word length.
UII (EPC code)	ARRAY[] OF WORD	31 words (62 bytes)	All bytes of the EPC code section that exceed the EPC word length in the StoredPC are filled with 00 hex.

GET NOISE LEVEL

● Function

This command measures the ambient noise level around the Reader/Writer.

● Command Area

Signal/data	Data type	Size	Function
CmdCode/Command Code	WORD	2 bytes	4202 hex
CmdParam1/Command Parameter 1	WORD	2 bytes	Channel acquisition start position 0001 hex to 0032 hex (1 to 50 CH) *1
CmdParam2/Command Parameter 2	WORD	2 bytes	No. of channels to be acquired 0001 hex to 0032 hex (1 to 50 CH) *1
Reserved/Reserved Area	WORD	2 bytes	0000 hex (Not used.)
Cnt Response/Update Counter Response	WORD	2 bytes	0000 hex (At command execution) The value is counted up due to a change in the update counter. For details, refer to <i>Update Counter/Update Counter Response</i> on page 7-10.

*1. List of channel numbers in each region

Model	JP	KR	TW	CN	IN/ID/EU/RU	MY/SG	US/MX
Number of channels	000F hex (15)	0013 hex (19)	000A hex (10)	0010 hex (16)	0004 hex (4)	0008 hex (8)	0032 hex (50)

● Response Area

Signal/data	Data type	Size	Function
ErrCode/Error Code	WORD	2 bytes	Error code
RespInfo1/Response Information 1	WORD	2 bytes	No. of channels (1 to 50)
RespInfo2/Response Information 2	WORD	2 bytes	0000 hex (Not used.)
RespInfo3/Response Information 3	WORD	2 bytes	0000 hex (Not used.)
Cnt/Update Counter	WORD	2 bytes	0000 to FFFF hex The value is counted up due to a change in the response area. For details, refer to <i>Update Counter/Update Counter Response</i> on page 7-10.

RespData/Response Data

Noise level (n CH)*1	WORD	2 bytes	Expresses the noise level (nCH) with an attached sign. FFFF to FF9D hex (-1 to -99) [dBm]
...
Noise level (mCH)*1	WORD	2 bytes	Expresses the noise level (mCH) with an attached sign. FFFF to FF9D hex (-1 to -99) [dBm]

*1. Specify a size so that the maximum value of m-n is contained in the response data.

If the value is not contained in the response data, a command error will occur.

GET COMMUNICATIONS DIAGNOSTIC INFORMATION

● Function

This command gets the most recent communications diagnostic information.

● Command Area

Signal/data	Data type	Size	Function
CmdCode/Command Code	WORD	2 bytes	4203 hex
CmdParam1/Command Parameter 1	WORD	2 bytes	0000 hex (Not used.)
CmdParam2/Command Parameter 2	WORD	2 bytes	0000 hex (Not used.)
Reserved/Reserved Area	WORD	2 bytes	0000 hex (Not used.)
Cnt Response/Update Counter Response	WORD	2 bytes	0000 hex (At command execution) The value is counted up due to a change in the update counter. For details, refer to <i>Update Counter/Update Counter Response</i> on page 7-10.

● Response Area (For Output_110)

Signal/data	Data type	Size	Function
ErrCode/Error Code	WORD	2 bytes	Error code ^{*1}
RespInfo1/Response Information 1	WORD	2 bytes	0000 hex (Not used.)
RespInfo2/Response Information 2	WORD	2 bytes	0000 hex (Not used.)
RespInfo3/Response Information 3	WORD	2 bytes	0000 hex (Not used.)
Cnt/Update Counter	WORD	2 bytes	0000 to FFFF hex The value is counted up due to a change in the response area. For details, refer to <i>Update Counter/Update Counter Response</i> on page 7-10.

Signal/data	Data type	Size	Function	
RespData/Response Data ^{*2}				
Newest communications diagnostic information	Time information	ARRAY[] OF BYTE	4 bytes	Expresses the time information. (Actual time flag, hour, minutes, and seconds)
	Command code	WORD	2 bytes	Expresses the command code.
	Error code	WORD	2 bytes	Expresses the error code.
	Diagnostic results	WORD	2 bytes	Expresses the diagnostic results. FFFF hex: Error (Set when the error code is not normal.) 0000 hex: Normal 0001 hex: Insufficient power to send 0002 hex: Insufficient power to receive 0003 hex: Too much noise 0005 hex: Insufficient read data ^{*3} 0006 hex: Excessive read data ^{*3}
	Diagnostic details	WORD	2 bytes	Expresses the diagnostic details. Bit 0: Insufficient power to send flag Bit 1: Insufficient power to receive flag Bit 2: Too much noise Bit 3: Reserved Bit 4: Insufficient data read flag ^{*3} Bit 5: Excessive data read flag ^{*3} Bits 6 to 15: Reserved (all zeros)
	Reserved 1	WORD	2 bytes	0000 hex: No specifications
	Reserved 2	WORD	2 bytes	0000 hex: No specifications
	Channel used	WORD	2 bytes	Expresses the channel used actually during communications. 0001 to 0064 hex (1 to 100) [CH]
	Communications Speed	WORD	2 bytes	Expresses the speed used actually during communications. 0001 hex: High speed 0002 hex: Normal speed
	Reception level	WORD	2 bytes	Expresses the reception level. FFDD to FF9D hex (-35 to -61 [dBm])
Noise level	WORD	2 bytes	Expresses the noise level. FFFF to FF9D hex (-1 to -99 [dBm])	
Target level	WORD	2 bytes	Expresses the target level. 0000 to 0064 hex (0 to 100)	
Reserved 3	WORD	2 bytes	0000 hex: No specifications	

- *1. When the communications mode is "Repeat", communications canceled/aborted is obtained. If you want to obtain the information prior to cancellation, refer to the communications diagnosis history on the Web screen.
- *2. Due to size restrictions of the response data, do not set StoredPC + UII (EPC code). If StoredPC+UII (EPC code) is necessary, issue the GET RF TAG ADDITIONAL INFORMATION command.
- *3. Diagnostic processing for these results is performed only in Focus Mode.

● Response Area (For Output_111, Output_112, Output_113)

Signal/data	Data type	Size	Function
ErrCode/Error Code	WORD	2 bytes	Error code ^{*1}
RespInfo1/Response Information 1	WORD	2 bytes	0000 hex (Not used.)
RespInfo2/Response Information 2	WORD	2 bytes	0000 hex (Not used.)
RespInfo3/Response Information 3	WORD	2 bytes	0000 hex (Not used.)

Signal/data	Data type	Size	Function
Cnt/Update Counter	WORD	2 bytes	0000 to FFFF hex The value is counted up due to a change in the response area. For details, refer to <i>Update Counter/Update Counter Response</i> on page 7-10.

RespData/Response Data

Newest communications diagnostic information	Time information	ARRAY[] OF BYTE	4 bytes	Expresses the time information. (Actual time flag, hour, minutes, and seconds)
	Command code	WORD	2 bytes	Expresses the command code.
	Error code	WORD	2 bytes	Expresses the error code.
	Diagnostic results	WORD	2 bytes	Expresses the diagnostic results. FFFF hex: Error (Set when the error code is not normal.) 0000 hex: Normal 0001 hex: Insufficient power to send 0002 hex: Insufficient power to receive 0003 hex: Too much noise 0005 hex: Insufficient read data ^{*2} 0006 hex: Excessive read data ^{*2}
	Diagnostic details	WORD	2 bytes	Expresses the diagnostic details. Bit 0: Insufficient power to send flag Bit 1: Insufficient power to receive flag Bit 2: Too much noise Bit 3: Reserved Bit 4: Insufficient data read flag ^{*3} Bit 5: Excessive data read flag ^{*3} Bits 6 to 15: Reserved (all zeros)
	Reserved 1	WORD	2 bytes	0000 hex: No specifications
	Reserved 2	WORD	2 bytes	0000 hex: No specifications
	Channel used	WORD	2 bytes	Expresses the channel used actually during communications. 0001 to 0064 hex (1 to 100) [CH]
	Communications Speed	WORD	2 bytes	Expresses the speed used actually during communications. 0001 hex: High speed 0002 hex: Normal speed
	Reception level	WORD	2 bytes	Expresses the reception level. FFDD to FF9D hex (-35 to -61 [dBm])
	Noise level	WORD	2 bytes	Expresses the noise level. FFFF to FF9D hex (-1 to -99 [dBm])
	Target level	WORD	2 bytes	Expresses the target level. 0000 to 0064 hex (0 to 100)
	Reserved 3	WORD	2 bytes	0000 hex: No specifications
StoredPC	WORD	2 bytes	Expresses the StoredPC data. The upper 5 bits are the UII (EPC) word length.	
UII (EPC code)	ARRAY[] OF WORD	31 words (62 bytes)	All bytes of the EPC code section that exceed the EPC word length in the StoredPC are filled with 00 hex.	

- *1. When the communications mode is "Repeat", communications canceled/aborted is obtained. If you want to obtain the information prior to cancellation, refer to the communications diagnosis history on the Web screen.
- *2. Diagnostic processing for these results is performed only in Focus Mode.
- *3. For details on StoredPC format, refer to 6.3.2.1.2.2 Protocol-control (PC) word (StoredPC and PacketPC) in Gen2 Regulations (Ver.2.0.0).

7-2-10 Time Charts

Using the Once Communications Option

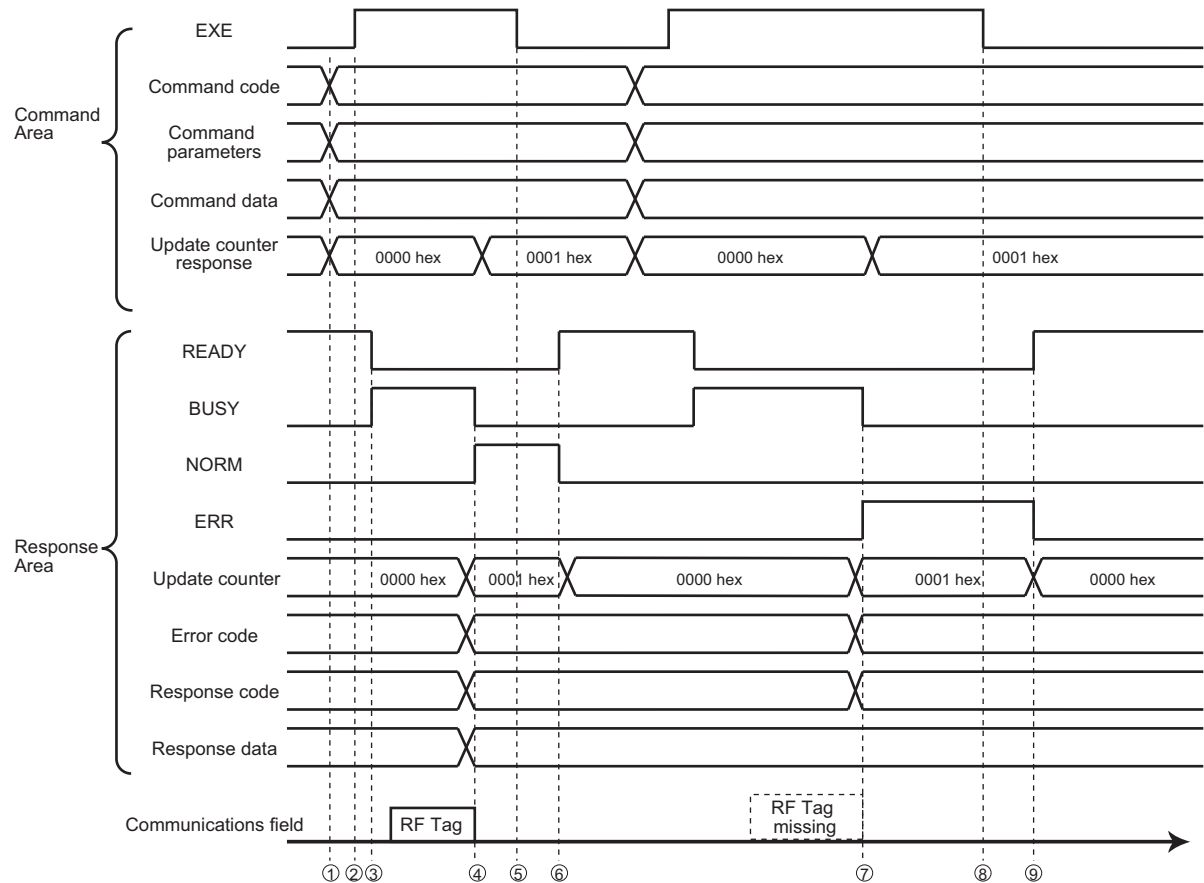

1. The command code, command parameters, and command data are set from the PLC while the READY signal is ON. The value of the update counter response is matched with the value of the Update counter in the V780 response area.
2. The user (PLC) turns ON the EXE signal. This tells the Reader/Writer to start execution.
3. When the Reader/Writer receives the instruction to start execution, it turns OFF the READY signal and turns ON the BUSY signal.
4. When the Reader/Writer detects an RF Tag and communications end normally, it sets the error code, response information, and response data, adds 1 (increments) to the update counter value, and then turns ON the NORM signal and turns OFF the BUSY signal.
5. The user (PLC) detects a change in the update counter value, confirms that the NORM signal has turned ON, and acquires the response data. After the acquisition of data, the user (PLC) updates the update counter response value in accordance with the value of the Update counter in the V780 response area, and turns OFF the EXE signal. This tells the Reader/Writer to stop execution.
6. When the Reader/Writer receives the instruction to stop execution, it turns OFF the NORM signal, clears the update counter, and turns ON the READY signal.
7. When the Reader/Writer cannot detect an RF Tag, or when command execution ends in an error due to failure of communications, etc., it sets the error code/response information, and turns ON the ERR signal. At this time too, the Reader/Writer adds 1 (increments) to the update counter value, and turns OFF the BUSY signal.
8. The user (PLC) detects a change in the update counter value, confirms that the ERR signal has turned ON, acquires the error code and response information, and then checks the error contents. After checking, the user (PLC) updates the update counter response value in accordance with the value of the Update counter in the V780 response area, and turns OFF the EXE signal. This tells the Reader/Writer to stop execution.
9. When the Reader/Writer receives the instruction to stop execution, it turns OFF the ERR signal, clears the update counter again, and turns ON the READY signal.

Using the Once Communications Option, MULTIACCESS ID READ and MULTIACCESS DATA READ Commands, and a Response Processing Time that is Shorter than the Communications Timeout

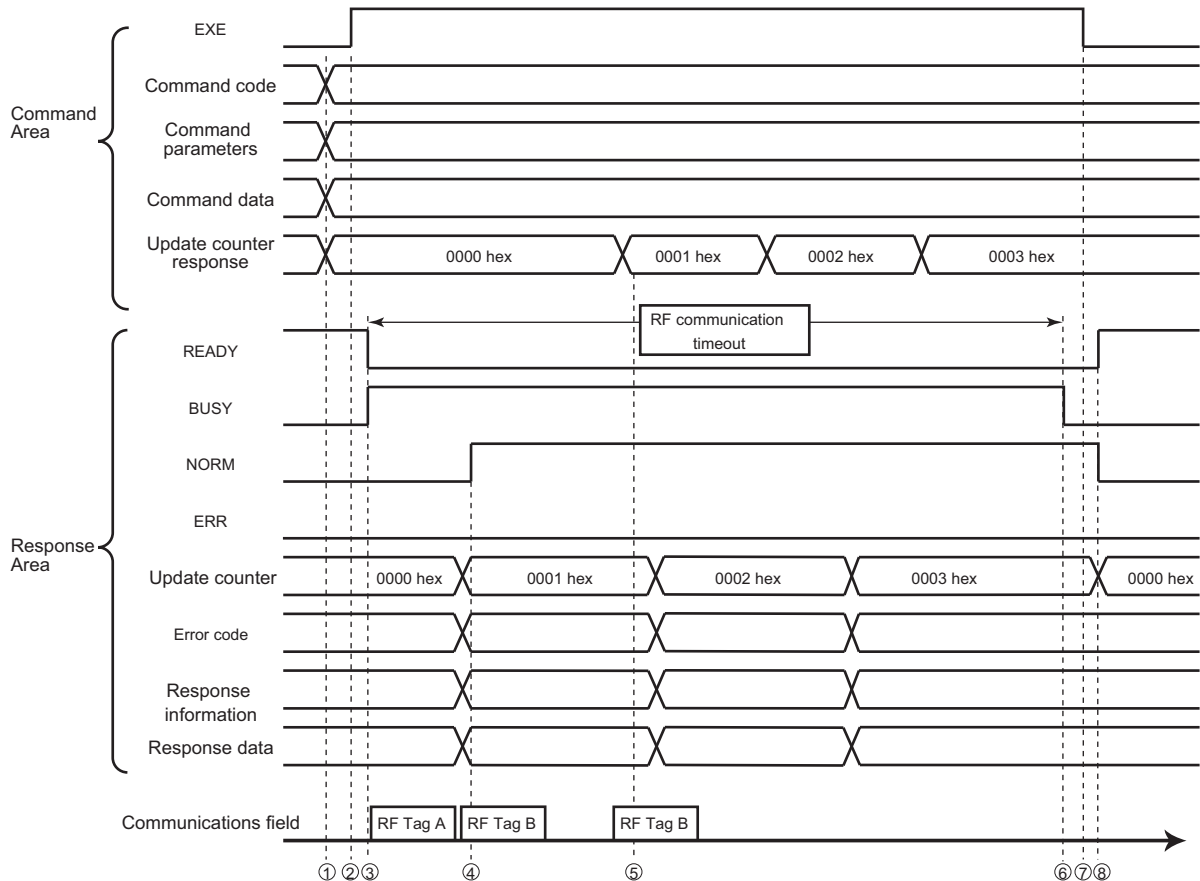

1. The command code, command parameters, and command data are set from the PLC while the READY signal is ON. The value of the update counter response is matched with the value of the Update counter in the V780 response area.
2. The user (PLC) turns ON the EXE signal. This tells the Reader/Writer to start execution.
3. When the Reader/Writer receives the instruction to start execution, it turns OFF the READY signal and turns ON the BUSY signal.
4. When the Reader/Writer detects an RF Tag and communications end normally, it sets the error code, response information, and response data, adds 1 (increments) to the update counter value, and then turns ON the NORM signal.
5. The user (PLC) detects a change in the update counter value, confirms that the NORM signal has turned ON, and acquires the response data. After the acquisition of data, the user (PLC) updates the update counter response value in accordance with the value of the Update counter in the V780 response area. In addition, if another RF Tag data is responded, the update counter of the Reader/Writer is again incremented. Therefore, at that time, the user (PLC) acquires the response data and updates the update counter response value.
6. When the Reader/Writer detects a communications timeout, and judges that there is no other response data, it turns OFF the BUSY signal.
7. Once the user (PLC) detects that the BUSY signal of the Reader/Writer has turned OFF, it turns OFF the EXE signal, and stops the execution of the command.
8. When the Reader/Writer detects that the EXE signal has turned OFF, it turns OFF the NORM signal, clears the update counter, and turns ON the READY signal.

Using the Once Communications Option, MULTIACCESS ID READ and MULTIACCESS DATA READ Commands, and a Response Processing Time that is Longer than the Communications Timeout

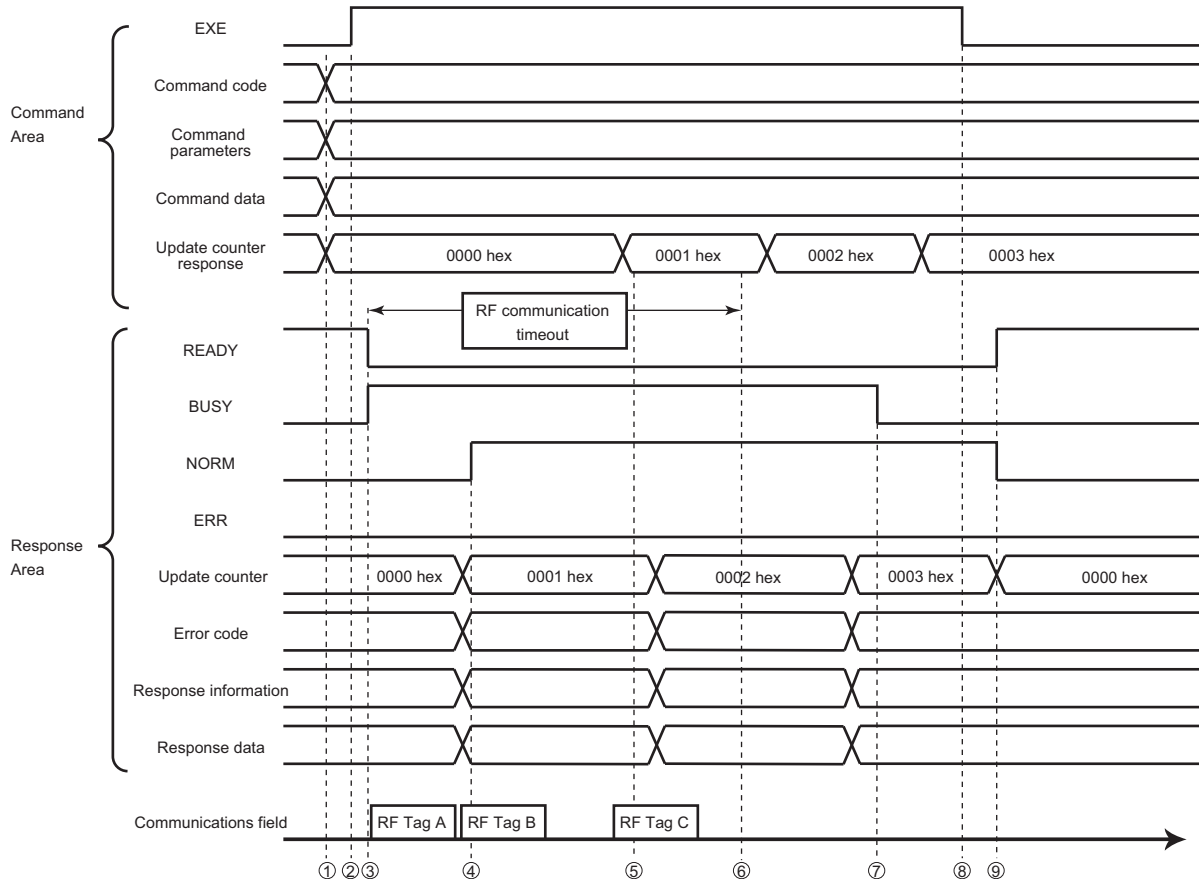

1. The command code, command parameters, and command data are set from the PLC while the READY signal is ON. The value of the update counter response is matched with the value of the Update counter in the V780 response area.
2. The user (PLC) turns ON the EXE signal. This tells the Reader/Writer to start execution.
3. When the Reader/Writer receives the instruction to start execution, it turns OFF the READY signal and turns ON the BUSY signal.
4. When the Reader/Writer detects an RF Tag and communications end normally, it sets the error code, response information, and response data, adds 1 (increments) to the update counter value, and then turns ON the NORM signal.
5. The user (PLC) detects a change in the update counter value, confirms that the NORM signal has turned ON, and acquires the response data. After the acquisition of data, the user (PLC) updates the update counter response value in accordance with the value of the Update counter in the V780 response area. In addition, if another RF Tag data is responded, the update counter of the Reader/Writer is again incremented. Therefore, at that time, the user (PLC) acquires the response data and updates the update counter response value.
6. When the Reader/Writer detects a communications timeout, it ends the communications with the RF Tag.
7. When the Reader/Writer finishes returning the entire response data, it turns OFF the BUSY signal.
8. Once the user (PLC) detects that the BUSY signal of the Reader/Writer has turned OFF, it turns OFF the EXE signal, and stops the execution of the command.
9. When the Reader/Writer detects that the EXE signal has turned OFF, it turns OFF the NORM signal, clears the update counter, and turns ON the READY signal.

Using the Auto Communications Option

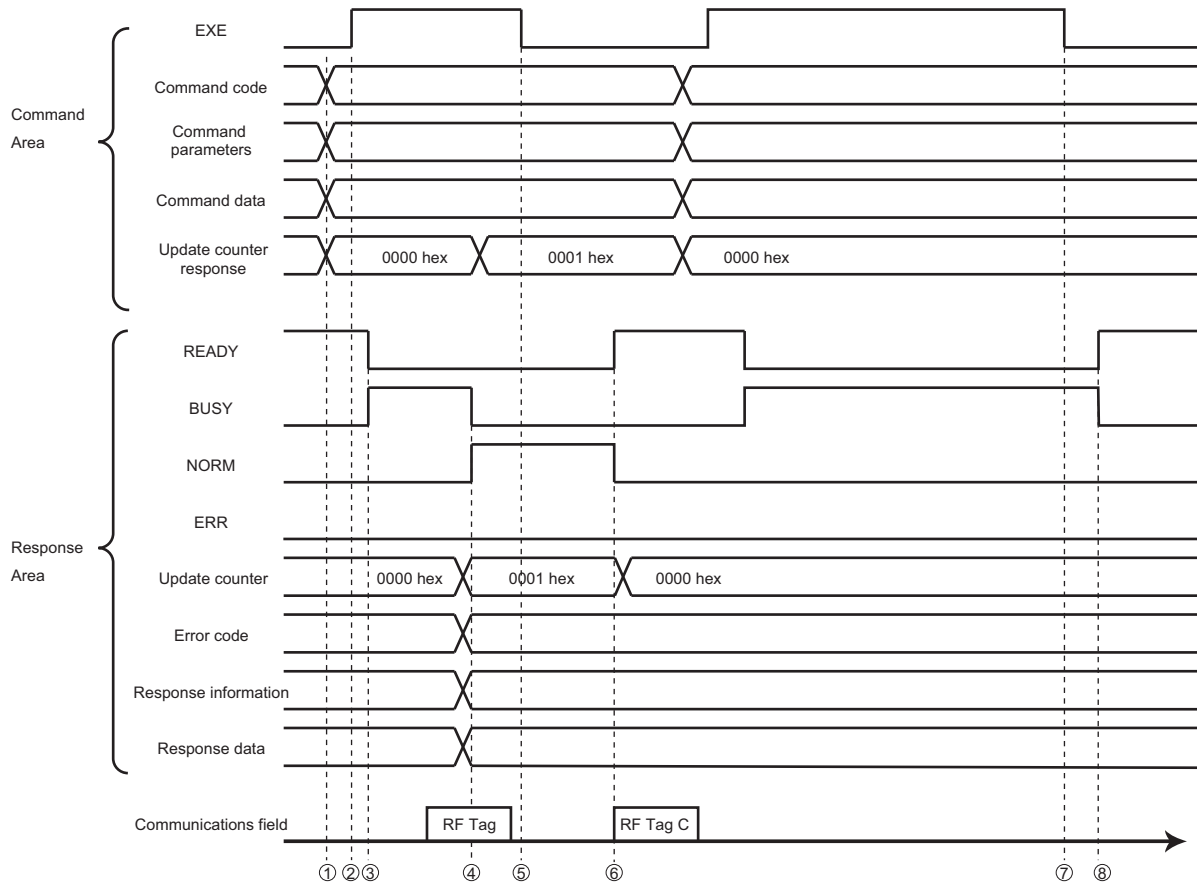

1. The command code, command parameters, and command data are set from the PLC while the READY signal is ON. The value of the update counter response is matched with the value of the Update counter in the V780 response area.
2. The user (PLC) turns ON the EXE signal. This tells the Reader/Writer to start execution.
3. When the Reader/Writer receives the instruction to start execution, it turns OFF the READY signal and turns ON the BUSY signal.
4. When the Reader/Writer detects an RF Tag and communications end normally, it sets the error code, response information, and response data, adds 1 (increments) to the update counter value, and then turns ON the NORM signal and turns OFF the BUSY signal.
5. The user (PLC) detects a change in the update counter, confirms that the NORM signal has turned ON, and acquires the response data. After the acquisition of data, the user (PLC) updates the update counter response value in accordance with the value of the Update counter in the V780 response area, and turns OFF the EXE signal. This tells the Reader/Writer to stop execution.
6. When the Reader/Writer receives the instruction to stop execution, it turns ON the READY signal and turns OFF the NORM signal.
7. If the BUSY signal is ON and the user (PLC) wants to cancel Auto communications, the user (PLC) turns OFF the EXE signal. This tells the Reader/Writer to stop execution.
8. When the Reader/Writer receives the instruction to stop execution, it turns ON the READY signal and turns OFF the BUSY signal.

Using the Auto Communications Option, MULTIACCESS ID READ and MULTIACCESS DATA READ Commands, and a Response Processing Time that is Shorter than the Communications Timeout

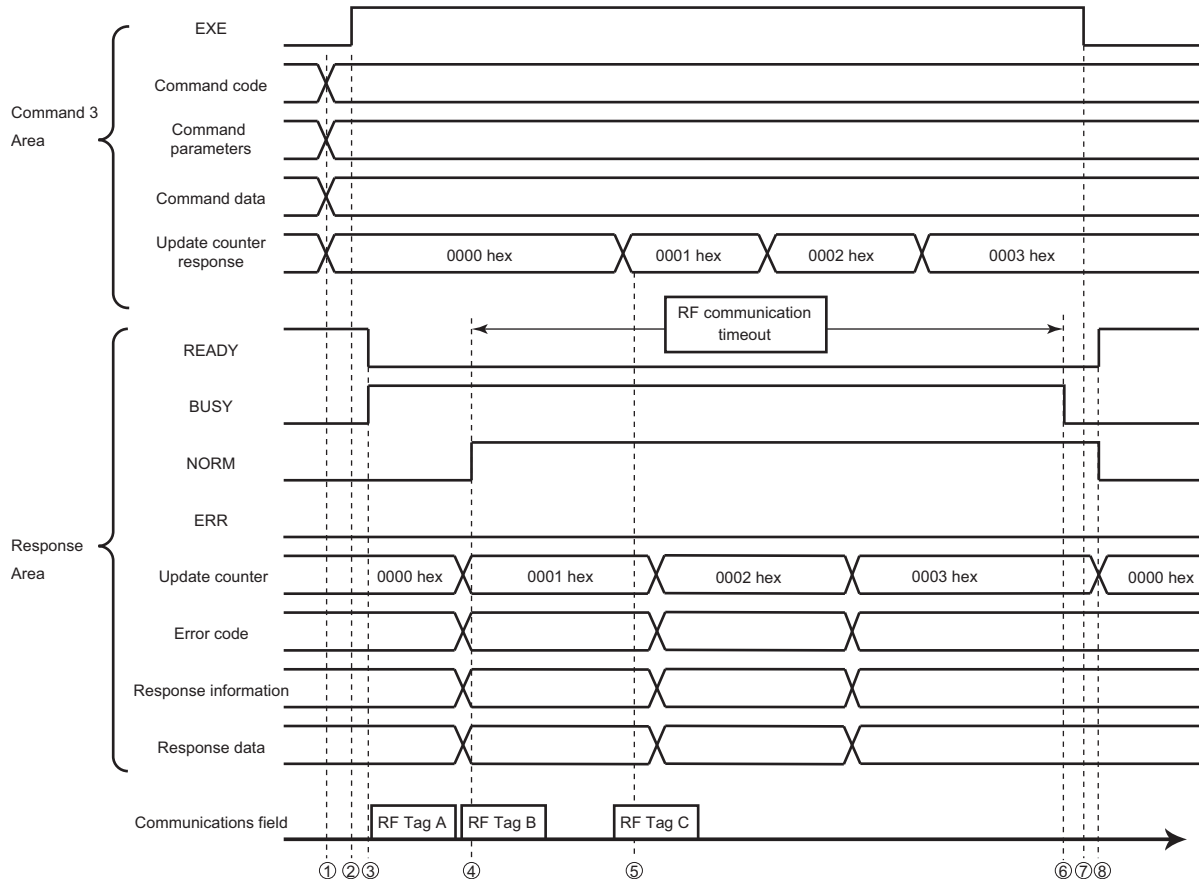

1. The command code, command parameters, and command data are set from the PLC while the READY signal is ON. The value of the update counter response is matched with the value of the Update counter in the V780 response area.
2. The user (PLC) turns ON the EXE signal. This tells the Reader/Writer to start execution.
3. When the Reader/Writer receives the instruction to start execution, it turns OFF the READY signal and turns ON the BUSY signal.
4. When the Reader/Writer detects an RF Tag and communications end normally, it sets the error code, response information, and response data, adds 1 (increments) to the update counter value, and then turns ON the NORM signal.
5. The user (PLC) detects a change in the update counter value, confirms that the NORM signal has turned ON, and acquires the response data. After the acquisition of data, the user (PLC) updates the update counter response value in accordance with the value of the Update counter in the V780 response area. In addition, if another RF Tag data is responded, the update counter of the Reader/Writer is again incremented. Therefore, at that time, the user (PLC) acquires the response data and updates the update counter response value.
6. When the Reader/Writer detects a communications timeout, and judges that there is no other response data, it turns OFF the BUSY signal.
7. Once the user (PLC) detects that the BUSY signal of the Reader/Writer has turned OFF, it turns OFF the EXE signal, and stops the execution of the command.
8. When the Reader/Writer detects that the EXE signal has turned OFF, it turns OFF the NORM signal, clears the update counter, and turns ON the READY signal.

Using the Repeat Communications Option

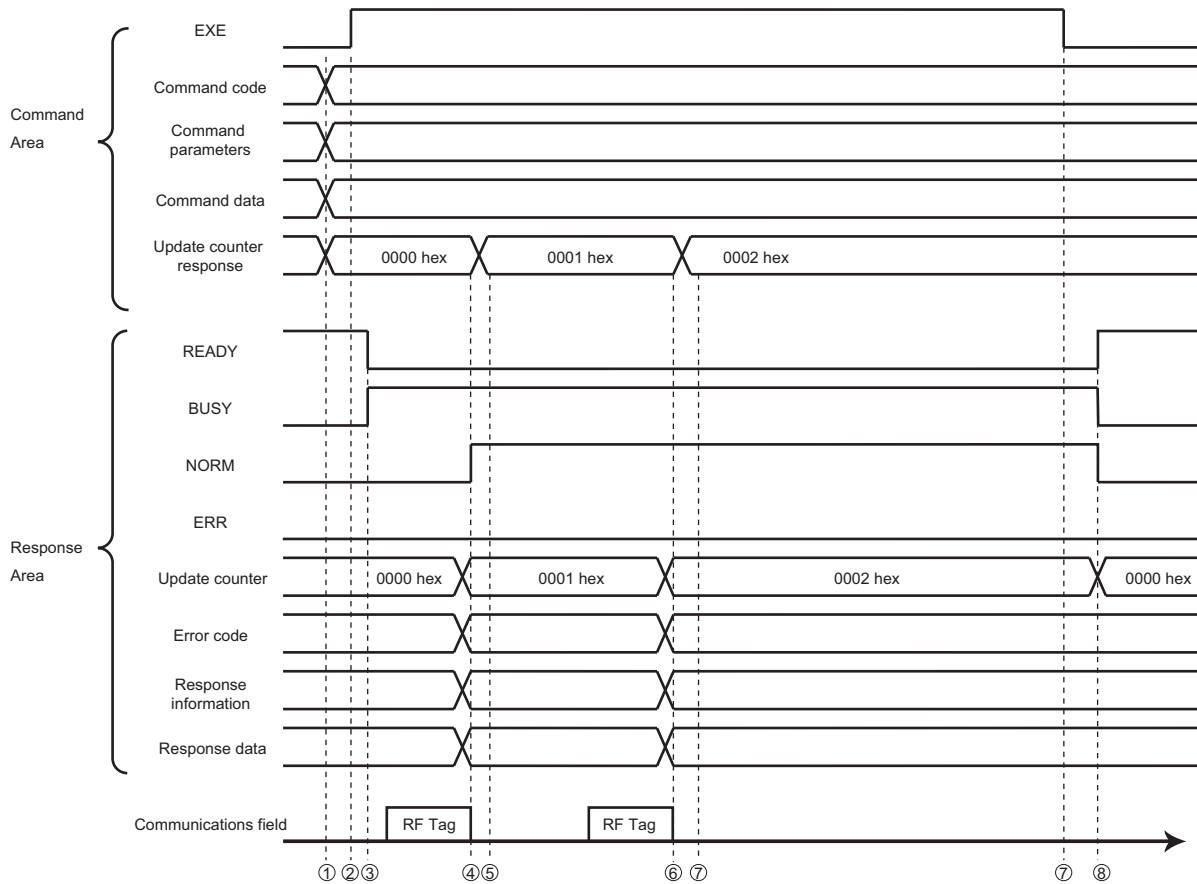

1. The command code, command parameters, and command data are set from the PLC while the READY signal is ON. The value of the update counter response is matched with the value of the Update counter in the V780 response area.
2. The user (PLC) turns ON the EXE signal. This tells the Reader/Writer to start execution.
3. When the Reader/Writer receives the instruction to start execution, it turns OFF the READY signal and turns ON the BUSY signal.
4. When the Reader/Writer detects an RF Tag and communications end normally, it sets the error code, response information, and response data, adds 1 (increments) to the update counter value, and then turns ON the NORM signal.
5. The user (PLC) detects a change in the update counter, confirms that the NORM signal has turned ON, and acquires the response data. After the acquisition of data, the user (PLC) updates the update counter response value in accordance with the value of the Update counter in the V780 response area.
6. When the Reader/Writer again detects another RF Tag and communications end normally, it sets the error code, response information, and response data, adds 1 (increments) to the update counter value, and then turns ON the NORM signal.
7. The user (PLC) detects a change in the update counter, confirms that the NORM signal has turned ON, and acquires the response data. After the acquisition of data, the user (PLC) again updates the update counter response value in accordance with the value of the Update counter in the V780 response area.
8. If the BUSY signal is ON and the user (PLC) wants to cancel Repeat communications, the user (PLC) turns OFF the EXE signal. This tells the Reader/Writer to stop execution.
9. When the Reader/Writer receives the instruction to stop execution, it turns ON the READY signal, turns OFF the BUSY signal and NORM signal, and clears the update counter.

Using the Once Communications Option and MULTIACCESS ID READ and MULTIACCESS DATA READ Commands

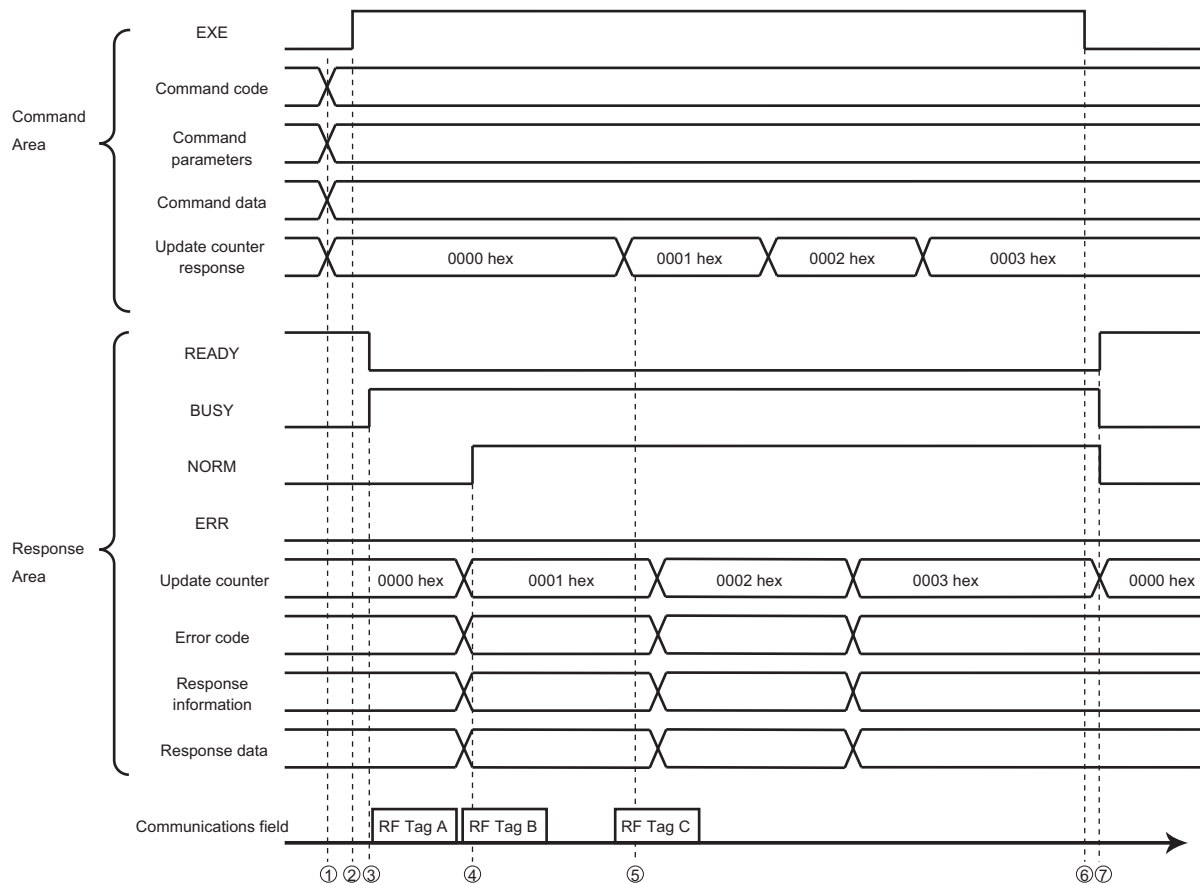

1. The command code, command parameters, and command data are set from the PLC while the READY signal is ON. The value of the update counter response is matched with the value of the Update counter in the V780 response area.
2. The user (PLC) turns ON the EXE signal. This tells the Reader/Writer to start execution.
3. When the Reader/Writer receives the instruction to start execution, it turns OFF the READY signal and turns ON the BUSY signal.
4. When the Reader/Writer detects an RF Tag and communications end normally, it sets the error code, response information, and response data, adds 1 (increments) to the update counter value, and then turns ON the NORM signal.
5. The user (PLC) detects a change in the update counter value, confirms that the NORM signal has turned ON, and acquires the response data. After the acquisition of data, the user (PLC) updates the update counter response value in accordance with the value of the Update counter in the V780 response area. In addition, if another RF Tag data is responded, the update counter at the Reader/Writer side is again incremented. Therefore, at that time, the user (PLC) acquires the response data and updates the update counter response value.
6. If the BUSY signal is ON and the user (PLC) wants to cancel Repeat communications, the user (PLC) turns OFF the EXE signal. This tells the Reader/Writer to stop execution.
7. When the Reader/Writer detects that the EXE signal has turned OFF, it turns OFF the BUSY signal, turns ON the READY signal, then turns OFF the NORM signal, and clears the update counter.

Executing Other Commands (such as SET READER/WRITER and GET READER/WRITER INFORMATION)

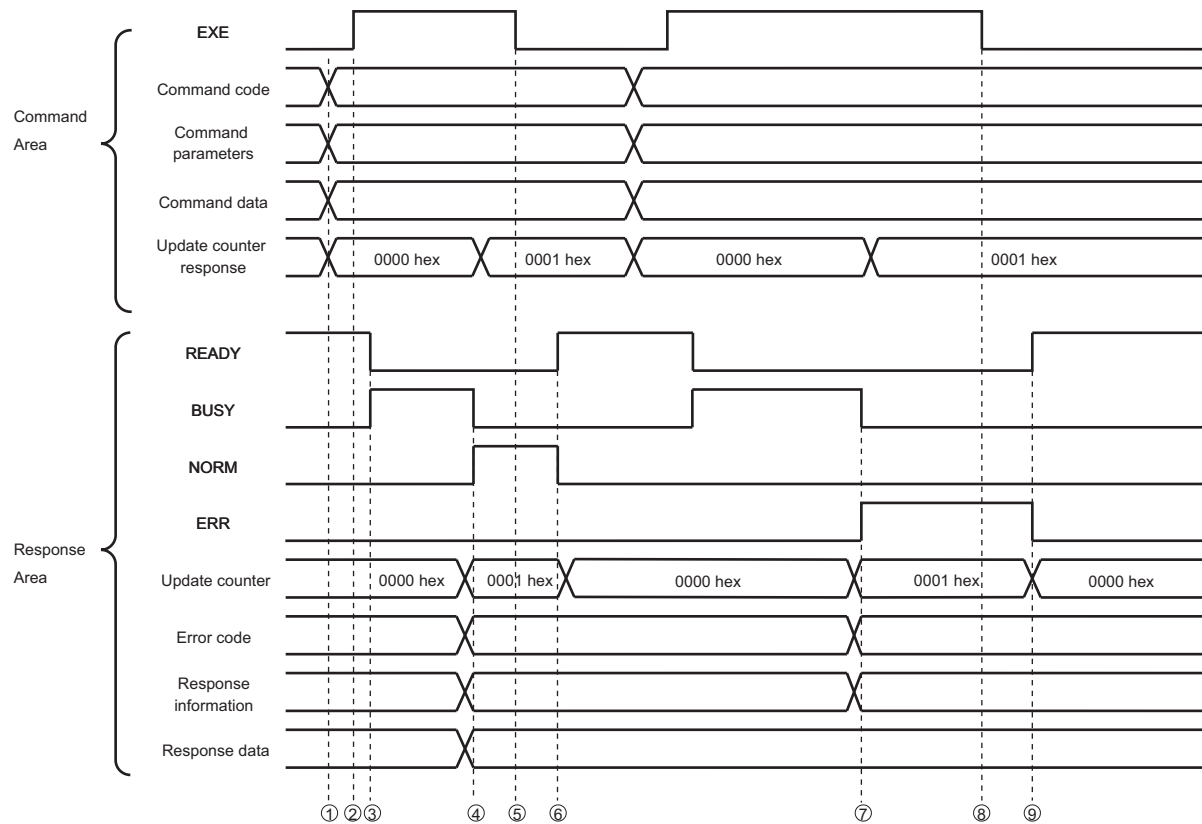

1. The command code, command parameters, and command data are set from the PLC while the READY signal is ON. The value of the update counter response is matched with the value of the Update counter in the V780 response area.
2. The user (PLC) turns ON the EXE signal. This tells the Reader/Writer to start execution.
3. When the Reader/Writer receives the instruction to start execution, it turns OFF the READY signal and turns ON the BUSY signal.
4. When the processing at the Reader/Writer side ends normally, the Reader/Writer sets the error code, response information, and response data, adds 1 (increments) to the update counter value, and then turns ON the NORM signal. Moreover, the Reader/Writer turns OFF the BUSY signal.
5. The user (PLC) detects a change in the update counter value, confirms that the NORM signal has turned ON, and acquires the response data. After the acquisition of data, the user (PLC) updates the update counter response value in accordance with the value of the Update counter in the V780 response area, and turns OFF the EXE signal. This tells the Reader/Writer to stop execution.
6. When the Reader/Writer receives the instruction to stop execution, it turns OFF the NORM signal and turns ON the READY signal.
7. When the processing at the Reader/Writer side ends in an error, the Reader/Writer sets the error code and response information, and turns ON the ERR signal. At this time too, the Reader/Writer adds 1 (increments) to the update counter value. And also turns OFF the BUSY signal.
8. The user (PLC) detects a change in the update counter value, confirms that the ERR signal has turned ON, acquires the error code and response information, and then checks the error contents. After checking, the user (PLC) updates the update counter response value in accordance with the value of the Update counter in the V780 response area, and turns OFF the EXE signal. This tells the Reader/Writer to stop execution.
9. When the Reader/Writer receives the instruction to stop execution, it turns OFF the ERR signal and turns ON the READY signal.

Executing the RESET Command (Reboot)

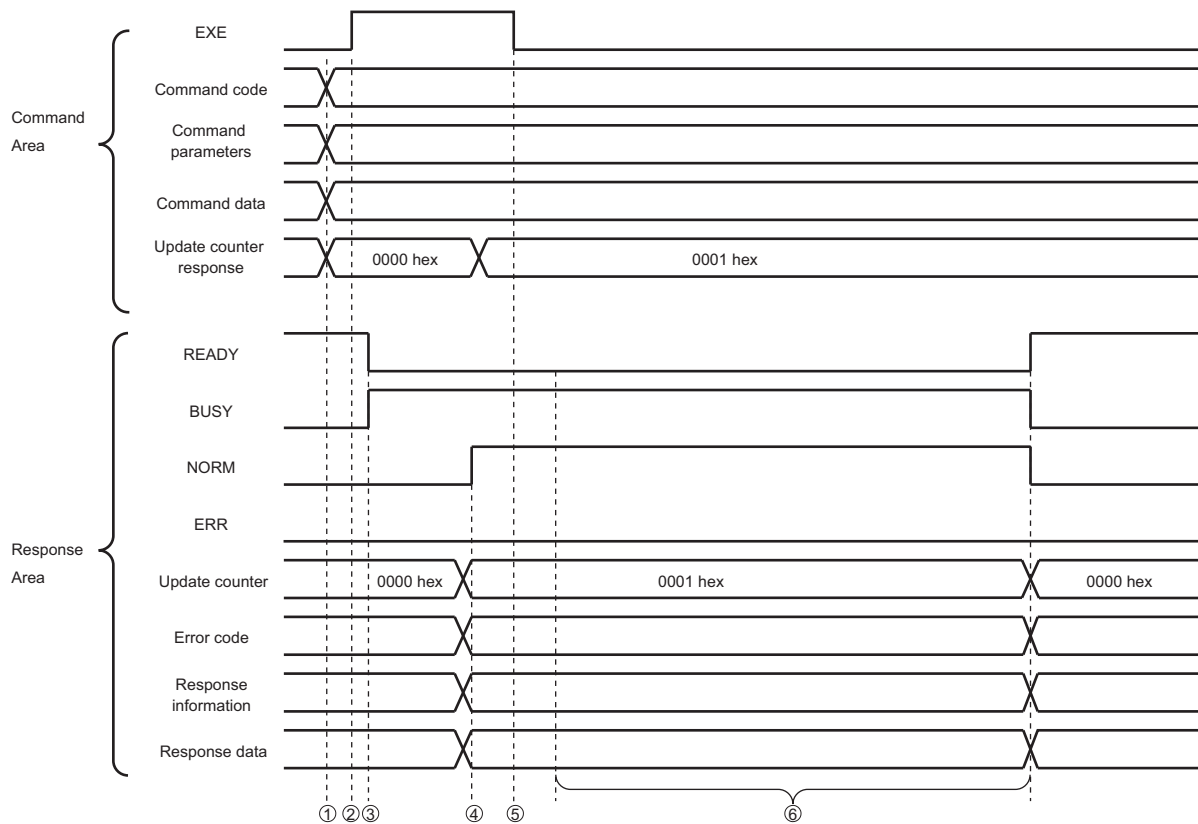

1. The command code, command parameters, and command data are set from the PLC while the READY signal is ON. The value of the update counter response is matched with the value of the Update counter in the V780 response area.
2. The user (PLC) turns ON the EXE signal. This tells the Reader/Writer to start execution.
3. When the Reader/Writer receives the instruction to start execution, it turns OFF the READY signal and turns ON the BUSY signal.
4. If the Reader/Writer can be reset, it sets the error code, response information, and response data, adds 1 (increments) to the update counter value, and then turns ON the NORM signal.
5. The user (PLC) detects a change in the update counter value, and confirms that the NORM signal has turned ON. Thereafter, the user (PLC) updates the update counter response value in accordance with the value of the Update counter in the V780 response area, and turns OFF the EXE signal. This tells the Reader/Writer to stop execution.
6. When the Reader/Writer receives the instruction to stop execution, it resets itself. If the connection of the tag data link is established after the Reader/Writer restarts, the READY signal turns ON and the BUSY signal turns OFF.



Browser Interface

This section describes the V780 Reader/Writer settings and operations that you can perform from a Web browser on a computer connected to the V780 Reader/Writer.

8-1	Browser Operation Interface	8-2
8-2	Operation Interface	8-4
8-2-1	Password Entry View	8-4
8-2-2	Status	8-5
8-2-3	Network Settings	8-6
8-2-4	RF Communications Settings	8-9
8-2-5	Device Settings	8-13
8-2-6	Tuning	8-15
8-2-7	Utilities	8-17
8-2-8	Logs	8-26
8-2-9	Rebooting	8-32
8-2-10	Configuration	8-33
8-2-11	Configuration File	8-41

8-1 Browser Operation Interface

Connect the Ethernet cable and start a Web browser on the computer.

Enter the IP address of the Reader/Writer in the address field of the Web browser to display the Browser Operation Interface.

Enter `http://192.168.1.200` if you are using the default IP address.

If a Web password is not set in the Reader/Writer, the Status View will be displayed first.

To display another view, click the specified menu button.



Precautions for Correct Use

Only one browser can connect to the Reader/Writer at one time. If another browser B connects to the Reader/Writer while browser A is displaying the Reader/Writer interface, the connection to browser A will be cut off. Communications may fail after browser B connects to the Reader/Writer. If that occurs, refresh your browser.

The system requirements to use the Web browser are as follows:

- Windows 7, Windows 8.1, or Windows 10 with Internet Explorer 8 or higher
- The combination of the firmware version and the JRE version

Reader/Writer firmware version	JRE version	Java8	
	Java7	Update74 to Update201	Update211 or later ^{*1}
Ver.3.00 or later	Available	Available	Available

*1. Commercial license is required for Java 8 Update 211(April 16, 2019).

`http://(IP_address)`

OMRON V780 RFID Reader/Writer

English

Status

Model: V780-HMD68-EIP-US

Firmware version:

Run mode program: 3.00

Safe mode program: 3.00

MAC address: 00-00-0A-9A-02-8C

Operation mode: RUN

Status: Idling

Clock: 0:39:14

Sync with PC

Reboot

configuration

Click a button to display the specified view.

Click this button to reboot the Reader/Writer.

Click this button to change to the Configuration View.

- * Windows is a registered trademark of Microsoft Corporation in the USA and other countries. Permission has been obtained from Microsoft to use screen captures.

- * Java software can be downloaded from the following URL:
URL: <https://www.oracle.com/technetwork/java/archive-139210.html>
(*URL is as of April 2019 and may change in the future.)
- Java and other trademarks that contain “Java” are the registered trademarks of Oracle Corporation or its related companies.



Precautions for Correct Use

- There may be problems with the display layout at any browser zoom rate other than 100%. We recommend that you set the zoom to 100%.
 - The browser interface communicates with the Reader/Writer periodically, which may cause the operating indicators on the Reader/Writer to light green.
 - The web browser of the Slave Reader/Writer (V780-HMD68-ETN-□□-S) is matched the Reader/Writer (V780-HMD68-ETN-□□) of Modus/TCP communication, there are some differences from the screen of this manual. For details, refer to Section 8 of “UHF RFID System V780-series Reader/Writer User’s Manual (Man. No. Z389)”.
-

8-2 Operation Interface

8-2-1 Password Entry View

If a Web password is set in the Reader/Writer, the Password Entry View will be displayed first. This view is not displayed for the default settings because a default password is not set.

OMRON V780 RFID Reader/Writer



Item name	Description
Password	Enter the Web password that is set in the Reader/Writer.



Additional Information

- If an error message is displayed when you click the **OK** Button, please recheck the password that you entered.
- If you start the Reader/Writer in Safe Mode, the Password Entry View will not be displayed even if a password is set.
- If you forget the password, set it again with the SET WEB PASSWORD command, or start the Reader/Writer in Safe Mode and clear the password from the Web interface.

8-2-2 Status

Click the **Status** Button. The Status View will be displayed.

You can use this view to check the device information for the Reader/Writer.

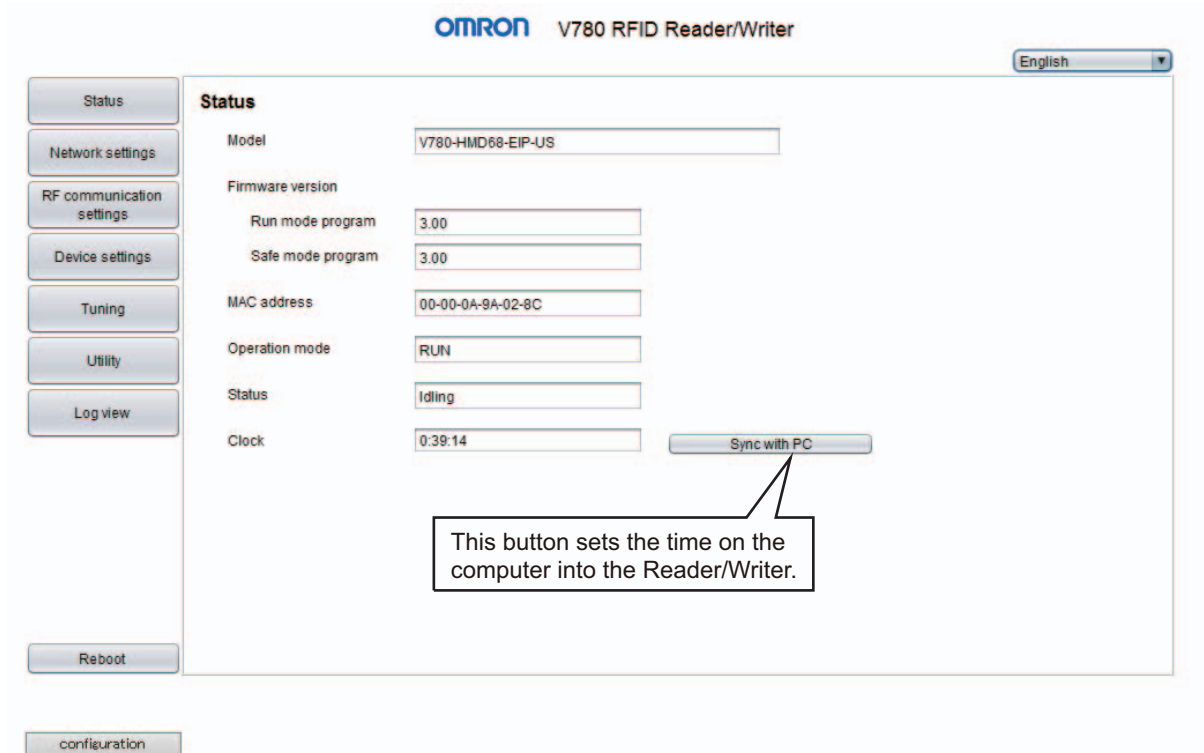

Item name		Description
Model		Displays the product model number.
Firmware version	Run mode program	Version notation: xx.yy
	Safe mode program	xx: Major version yy: Minor version
MAC address		Displays the MAC address of the Reader/Writer.
Operation mode		Displays the operation mode of the Reader/Writer. <i>6-1 Operation Modes</i> on page 6-3
Status		Displays the status of the Reader/Writer. Idling: The Reader/Writer is on standby. RF communications in progress: The Reader/Writer is communicating with an RF Tag. Change settings: The settings of the Reader/Writer are being changed. System error: An error has occurred in the Reader/Writer.
Clock		Displays the time since the Reader/Writer was started. Example: 0:12:34 (0 hours, 12 minutes, 34 seconds) If you click the Sync with PC Button, the time on the computer will be displayed.

8-2-3 Network Settings

TCP/IP Settings

Click the **Network settings** Button and then click the **TCP/IP** Tab.

A tab page to set the IP address and other network settings will be displayed. You can edit the settings.

Item name	Description	Default
IP address setting method	Select one of the following: Fixed setting, Obtain from BOOTP server, or Fix at the IP address which is obtained from BOOTP server.	Fixed setting
Fixed setting	Operation is performed with the fixed IP address that is set.	---
IP address	Enter the fixed IP address.	192.168.1.200
Subnet mask	Enter the subnet mask (IPv4) that is used to identify the network address and host address within the IP address.	255.255.255.0
Gateway address	Enter the IP address of the gateway to use to reach networks outside the one that the Reader/Writer is on.	192.168.1.254
Obtain from BOOTP server	The IP address will be obtained from the BOOTP server every time the power supply to the Reader/Writer is turned ON.	---
Fix at the IP address which is obtained from BOOTP server	The IP address will be obtained from the BOOTP server only one time when the Reader/Writer is restarted after this setting is made. After that, operation will be performed with the fixed IP address.	---
Device name	Enter a name to use to identify the Reader/Writer on the network. Setting range: 63 ASCII characters max.	None



Precautions for Correct Use

If you change the IP address setting method from Fixed setting to Obtain from BOOTP server or Fix at the IP address which is obtained from BOOTP server, the IP address, subnet mask, and default gateway that are set for Fixed setting become 0. If necessary, perform a backup in advance.

Port Settings

Click the **Network settings** Button and then click the **Port setting** Tab.

A tab page will be displayed to set the communications ports. You can edit the settings.

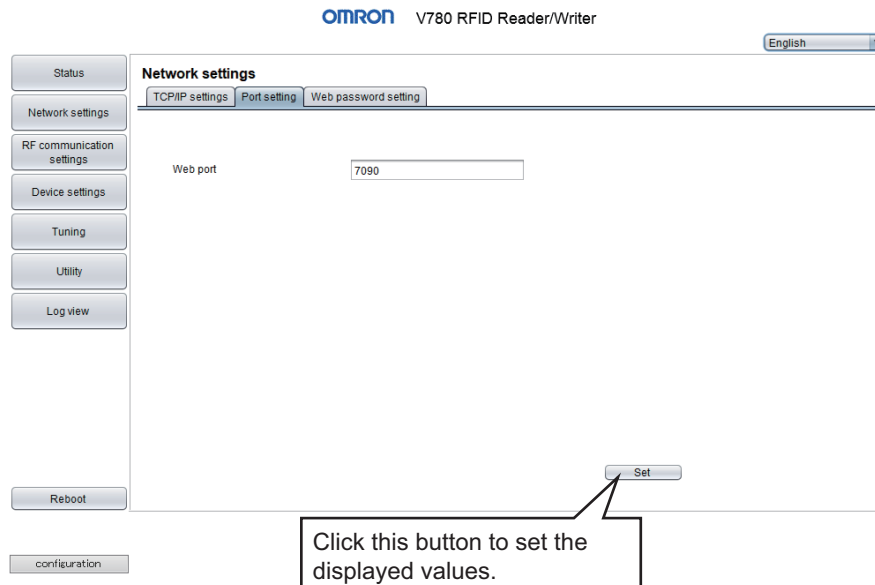

Item name	Description	Default
Web port	Enter the logical port number to use for TCP/IP communications with the client-side application on the Web browser interface. Setting range: 1024 to 65535	7090



Precautions for Correct Use

- If you change any of the network settings, restart the Reader/Writer. The new settings will be enabled after the Reader/Writer is restarted.
- If you change the IP address and restart the Reader/Writer, the Web browser interface will not reconnect to the Reader/Writer. The browser interface will be displayed again if you set the new IP address in the address box of your Web browser.
- If you change the settings while the Reader/Writer is performing RF Tag communications, noise measurement, or other processing, an error message will be displayed. Change the settings when the Reader/Writer is in idle state.

Web Password Setting

Click the **Network settings** Button and then click the **Web password setting** Tab. A tab page to set the Web password will be displayed. You can edit the setting.

Item name	Description	Default
Web password	Enter the login password for the Web browser interface. Setting range: 15 ASCII characters max.	None
Web password (confirmation)	Enter the login password that you entered in the Web password Box again. Setting range: 15 ASCII characters max.	None



Precautions for Correct Use

- If you change any of the network settings, restart the Reader/Writer. The new settings will be enabled after the Reader/Writer is restarted.
- If you change the settings while the Reader/Writer is performing RF Tag communications, noise measurement, or other processing, an error message will be displayed. Change the settings when the Reader/Writer is in idle state.

8-2-4 RF Communications Settings

Basic Settings

Click the **RF communication settings** Button and then click the **Basic settings** Tab.

A tab page to set the basic parameters for communications with RF Tags will be displayed. You can edit the settings.

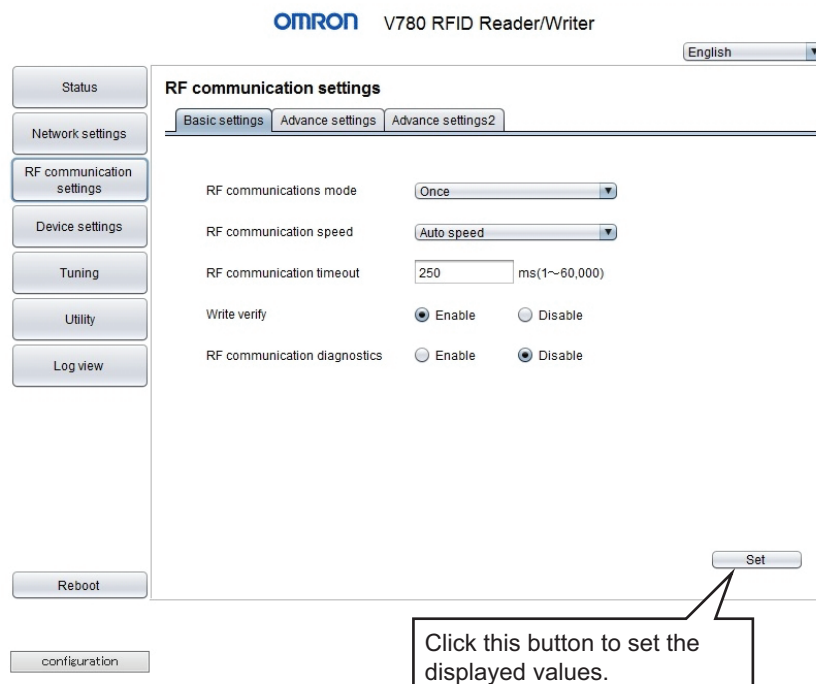

Item name	Description	Default
RF communication mode	Select the communications mode. Setting range: Once, Auto, or Focus / Repeat	Once
RF communication speed	Select the speed of communications with the RF Tags. Setting range: Auto speed, High speed, or Normal speed	Auto speed
RF communication timeout	Enter the timeout time for RF communications in milliseconds. Setting range: 1 to 60,000 ms	250 ms
Write verify	Select whether or not to use write verification. Setting range: Enable or Disable	Enable
RF communication diagnostics	Select whether or not to use RF communications diagnostics. Setting range: Enable or Disable	Disable

For information on the basic settings, refer to 6-4-2 *RF Communications Conditions: Basic Settings* on page 6-24.



Precautions for Correct Use

- Click the **Set** Button. The settings will be applied immediately.
- If you change the settings while the Reader/Writer is performing RF Tag communications, noise measurement, or other processing, an error message will be displayed. Change the settings when the Reader/Writer is in idle state.

Advanced Settings

Click the **RF communication settings** Button and then click the **Advanced settings** Tab.

A tab page to set the advanced parameters for communications with RF Tags will be displayed. You can edit the settings.

Item name	Description	Default
Tx power (Read) and Tx power (Write)	Enter the reading transmission power and the writing transmission power separately for the antenna output. Setting range: 15 to 27	27
Channel* ¹	Select the frequency channel to use. For details on the settings, refer to <i>Channel</i> on page 6-27.	Auto channel
Gen2 session	Select the value for the Gen2 session flag. Setting range: S0, S1, S2, or S3	S0
Access password	Enter the RF communications access password in eight hexadecimal digits.	00000000
Transmission time	Enter the time to output radio waves continuously and the stop time when the Reader/Writer communicates with RF Tags.	—
Continuous time	Enter the maximum time to continuously output radio waves during communications command execution. Setting range: [V780-HMD68-EIP-JP] 0 or 400 to 10000 [ms] *If you set 0, the time will be infinite.* ² [Models other than V780-HMD68-EIP-JP] Cannot set the Continuous time.	* ³
Stop time	Enter the time to pause output during communications command execution. Setting range: [V780-HMD68-EIP-JP] 0 or 10 to 1000 [ms] *If you set 0, the time will be 0.* ² [V780-HMD68-EIP-KR/-TW/-CN/-MY/-US/-MX] 10 to 1000 [ms] [V780-HMD68-EIP-IN/-EU/-RU] 100 to 1000 [ms]	* ³

- *1. The channel used can only be specified in models V780-HMD68-EIP-JP/-IN/-EU/-RU. The channel cannot be specified in the other models.
- *2. You cannot specify either one of the stop time and continuous transmission time as 0 in the model V780-HMD68-EIP-JP.
- *3. The default settings depends on the each model number. For details, refer to *Transmission Time* on page 6-29.

For information on the advanced settings, refer to *6-4-3 RF Communications Conditions: Advanced Settings* on page 6-26.



Precautions for Correct Use

- Click the **Set** Button. The settings will be applied immediately.
 - If you change the settings while the Reader/Writer is performing RF Tag communications, noise measurement, or other processing, an error message will be displayed. Change the settings when the Reader/Writer is in idle state.
-

Advanced Settings 2

Click the **RF communication settings** Button and then click the **Advanced settings 2** Tab.

A tab page to set the advanced parameters for communications with RF Tags will be displayed. You can edit the settings.

RF communication settings

Basic settings Advance settings **Advance settings2**

RSSI filter

Enable Disable

High threshold - dBm(-70~-10)

Low threshold - dBm(-70~-10)

RF Tag select filter

Enable Disable

Memory address Hex (1000~17FF/2000~27FF/3000~3FFF)

Verification data Hex (MAX 16 Word)

Smoothing buffer

Registration number number of EPC(0~1024)

Click this button to set the displayed values.

Item name	Description	Default
RSSI filter	Select whether or not to use filtering for reception levels. Setting range: Enable or Disable	Disable
High threshold	Enter the high threshold for the reception level. Setting range: 0 or -70 to -10	---
Low threshold	Enter the low threshold for the reception level. Setting range: 0 or -70 to -10	---
RF Tag select filter	Select whether or not to use filtering for RF Tag data verification.	Disable
Memory address	Enter the memory address to use for verification in the RF Tags. Setting range: 1000 to 17FF hex (UII (EPC) area) 2000 to 27FF hex (TID area) 3000 to 37FF hex (user area)	---
Verification data	Enter the data to verify with the data in the RF Tags. Setting range: 16 hexadecimal words max.	---
Smoothing buffer	Enter the number of smoothing buffers when the communications mode is set to Repeat . Setting range: 0 to 1024 (The smoothing buffer is disabled at 0)	1024

For information on the advanced settings, refer to 6-4-3 *RF Communications Conditions: Advanced Settings* on page 6-26.



Precautions for Correct Use

- Click the **Set** Button. The settings will be applied immediately.
- If you change the settings while the Reader/Writer is performing RF Tag communications, noise measurement, or other processing, an error message will be displayed. Change the settings when the Reader/Writer is in idle state.

8-2-5 Device Settings

Operation Indicator Custom Settings

Click the **Device settings** Button and then click the **LED custom settings** Tab.

A tab page to customize the operation indicators on the Reader/Writer will be displayed. You can edit the settings.

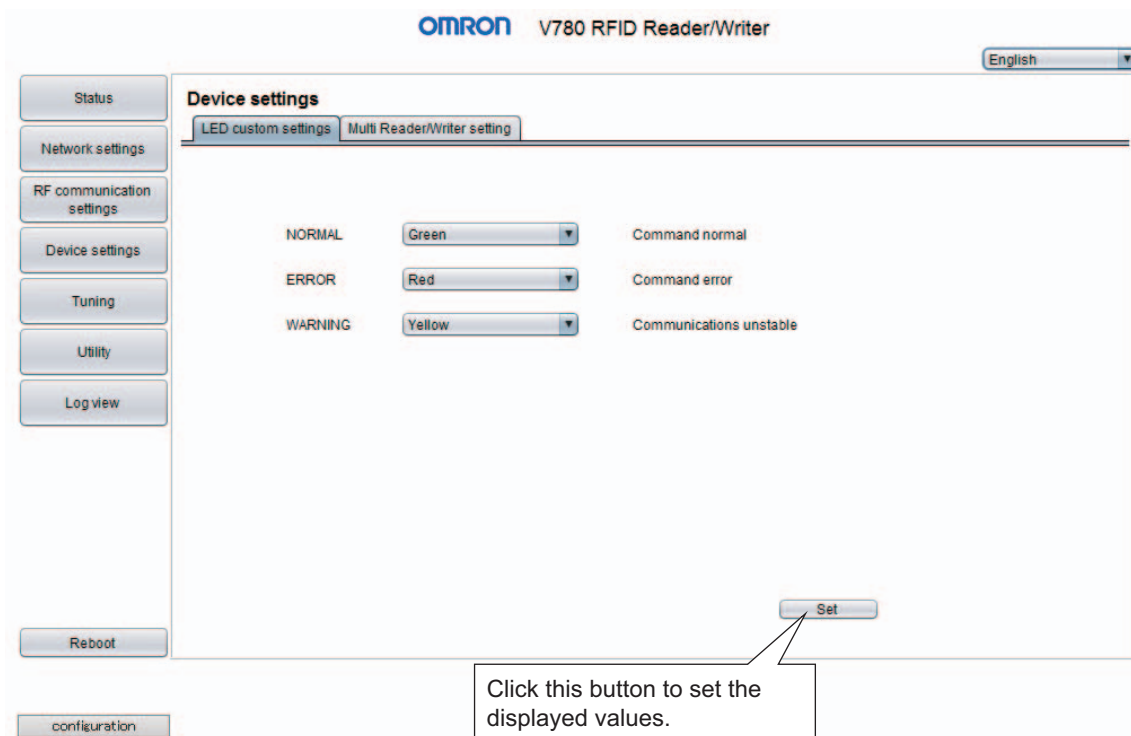

Item name	Description	Default
Command normal (NORMAL)	Select the color for the indicators to light when processing a communications command or another command from the host device is completed normally. Setting range: Red, Green, Blue, Yellow, Cyan, Magenta, White, or OFF	Green
Command error (ERROR)	Select the color for the indicators to light when processing a communications command or another command from the host device ends in an error. Setting range: Red, Green, Blue, Yellow, Cyan, Magenta, White, or OFF	Red
Unstable communications (WARNING)	Select the color for the indicators to light when an unstable communication is detected while communications diagnosis is enabled. Setting range: Red, Green, Blue, Yellow, Cyan, Magenta, White, or OFF	Yellow

For details on custom settings for operation indicators, refer to *6-4-4 Device Settings* on page 6-33.



Precautions for Correct Use

- If you change any of the device settings, restart the Reader/Writer. The settings will be applied after the Reader/Writer is restarted.
- If you change the settings while the Reader/Writer is performing RF Tag communications, noise measurement, or other processing, an error message will be displayed. Change the settings when the Reader/Writer is in idle state.

Multi-Reader/Writer Setting

Click the **Device settings** Button and then click the **Multi-Reader/Writer setting** Tab.

A tab page to customize the multi-reader/writer on the Reader/Writer will be displayed.

The slave reader/writer (V780-HMD68-ETN-□□-S) and Standard Reader/Writer set to SLAVE mode can not change the multi reader/writer configuration setting.

Click Update Button to re-get the status of each Slave Reader/Writer stored in the Master Reader/Writer.
 * The status of the Slave Reader/Writer stored in the Master Reader/Writer varies under the following conditions.

1. Multi Reader Writer Mode is during normal or abnormal startup
2. From Master Reader/Writer to Slave Reader/Writer during communications failed or success.

Click this button to set the displayed values.

Item name	Description	Default
Multi-Reader/Writer Mode	Select whether or not to use the Multi-Reader/Writer mode. Setting range: Enabled or Disabled	Disable
Mode Selection	This selects the mode if the Multi-Reader/Writer mode is enabled. Setting Range: Field Extension Mode	
Slave Reader/Writer Status	This gives the status of each slave Reader/Writer. Connected: (Green) Not connected: (Red) Communications failed: (Red) Not registered: (Gray)	
IP address	This gives the IP addresses assigned to each Reader/Writer.	
Tx power(Read)	This gives the value of the read transmission power, and a level bar, for each slave Reader/Writer.	
Tx power(Write)	This gives the value of the write transmission power, and a level bar, for each slave Reader/Writer.	

8-2-6 Tuning

Transmission Power Tuning

Click the **Utility** Button, and then click the **Transmission power tuning** Tab. A tab page to automatically adjust the transmission powers of the Reader/Writer will be displayed. You can adjust or set the transmission power separately for read communications and write communications. When the Multi-Reader/Writer function is enabled, it is possible to select the reader/writer subject to automatic adjustment and setting.



Precautions for Correct Use

This tab page cannot be used if the Reader/Writer is started in Safe Mode or SLAVE Mode. Use this tab page when the Reader/Writer is operating in Run Mode.

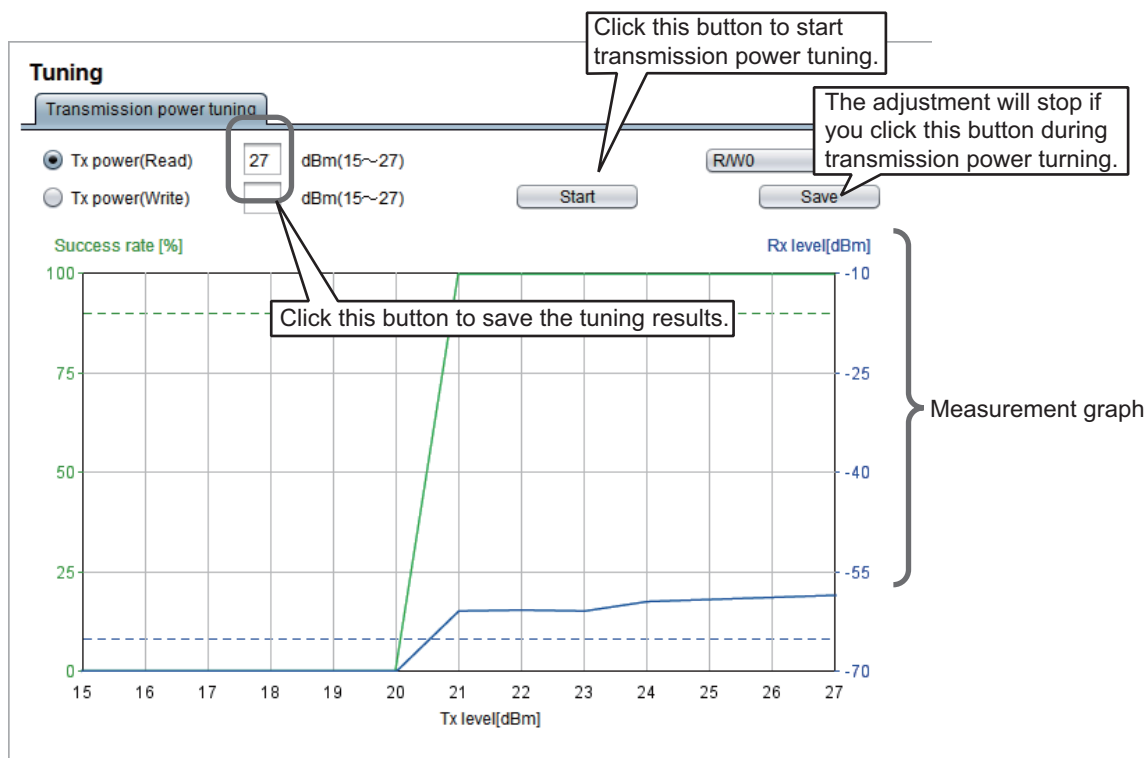

Item name	Description	Remarks
Tx power (Read) and Tx power (Write)	Select the transmission power to adjust: reading or writing. If tuning is completed successfully, the transmission power that was determined to be optimum will be displayed. If tuning fails, -1 will be displayed.	
Measurement graph	During tuning, the broken-line graph will show the communications success rates and reception levels against time for each transmission power.	
Communications success rate	The optimum power is determined based on a success rate of 90% or higher. This displays the slave Reader/Writers to which the master reader/writer is connected.	
Reception level	The optimum power is determined based on a level of -65 dBm or higher.	

For information on transmission power tuning, refer to 6-8-1 *Transmission Power Tuning* on page 6-45.

● Saving Files

You can click the **Save** Button on the Transmission Power Tuning Tab Page to save the results of transmission power tuning at a specified path and file name. The transmission power tuning results are saved in a CSV file in the following format.

```

CSV Format
Tx level[dBm], Success rate[%], RX level[dBm]
  15,    <communications_success_rate>, <reception_level>
  :      :                               :
  27,    <communications_success_rate>, <reception_level>
Tuning result :, before=XX[dBm], after=YY[dBm]

```

Item name	Description	Remarks
Tx level[dBm]	Gives the transmission powers that were swept through during tuning. 15 to 27	
Success rate[%]	Gives the communications success rates for the RF Tags measured for each transmission power. 0 to 100	
Rx level[dBm]	Gives the transmission levels measured for each transmission power. 0 or -1 to -99	
Tuning result : before=XX[dBm], after=YY[dBm]	Gives the tuning results. XX: Gives the transmission power that was set before tuning. YY: Gives the transmission power that was set after tuning. (If tuning fails, the value will be -1.)	

8-2-7 Utilities

RF Tag Access

Click the **Utility** Button, and then click the **RF Tag access** Tab.

A tab page to use RF communications commands to access RF Tags will be displayed. You can use this tab page to check operation for reading and writing the RF Tag UIIs (EPC codes) or data at any RF Tag addresses.



Precautions for Correct Use

This tab page cannot be used if the Reader/Writer is started in Safe Mode or SLAVE Mode. Use this tab page when the Reader/Writer is operating in Run Mode.

Utility

RF Tag access | RF Tag scan | Reception level monitor | Channel monitor | Focus monitor

ID read: [dropdown] Data address: [input] Data size: [input]
Write data: [input]

Repeat

Result: Normal Time: 46 msec

Read data:
3000112233445566778899AABBCC0000000000000000000000000000

Summary: max:46, min:46, ave:46 (msec) No. of comms: 1

Click this button to send the selected command.
If you click this button while a command is being repeatedly sent, repeatedly sending the command will be stopped.

Click this button to delete the information displayed in the Read data Area.

Item name	Description
RF communications command	Select the command to send. Setting range: ID read (ID READ), ID write (ID WRITE), Data read (DATA READ), or Data write (DATA WRITE)
Data address	Enter the first RF Tag address to read or write in four hexadecimal digits. Setting range: 0000 to 3FFF hex
Data size	If you specify reading data, enter the data size to read in four hexadecimal digits. If you specify writing data, the Write data box will display the count of the data size in four hexadecimal digits. Setting range: 0001 to 0078 hex
Write data	Enter hexadecimal words for the data to write to the RF Tag. Setting range: 120 words max.
Repeat	Select this check box to repeatedly send the command.

Item name	Description
Result	The communications result and a description will be displayed. The display color depends on the communications result, as follows: <ul style="list-style-type: none">• Normal: Green• Warning: Yellow• Error: Red
Time	The time required to communicate with the RF Tag will be displayed.
Read data	Displays the read data of ID read or Data read.
Summary	The maximum, minimum, and average communications times will be displayed.
No. of comms	The number of communications between the Reader/Writer and RF Tag will be displayed.

For information on RF Tag access, refer to *6-9-1 RF Tag Access* on page 6-48.

RF Tag Scanning

Click the **Utility** Button, and then click the **RF Tag scan** Tab.

A tab page to scan for RF Tags will be displayed. You can use this tab page to check for RF Tags in the communications field of the Reader/Writer.

Results of RF Tag scanning are displayed for up to 64 RF Tags.



Precautions for Correct Use

This tab page cannot be used if the Reader/Writer is started in Safe Mode or SLAVE Mode. Use this tab page when the Reader/Writer is operating in Run Mode.

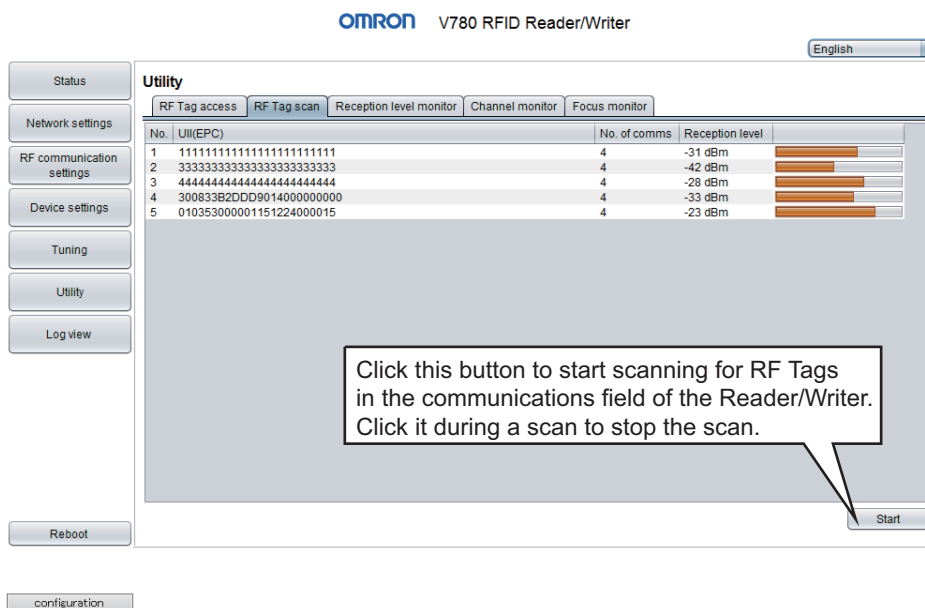

Item name	Description	Remarks
No	Displays the index numbers of the RF Tags.	
UII (EPC)	Displays the UIIs (EPC codes) of the RF Tags that were detected in the scan.	
No. of comms	Displays the numbers of communications with the RF Tags during the scan.	
Reception level	Displays the most recent reception levels measured during the scan numerically and as a bar graph.	

For information on RF Tag scanning, refer to 6-9-2 *RF Tag Scanning* on page 6-49.

Reception Level Monitor

Click the **Utility** Button, and then click the **Reception level monitor** Tab.

A tab page to monitor the reception levels from RF Tags will be displayed. You can use this tab page to adjust the installation and check the communications field.

When the Multi-Reader/Writer function is enabled, it is possible to select multiple Reader/Writers subject to communications with RF Tags.

Results of RF Tag monitoring are displayed for up to 8 RF Tags.



Precautions for Correct Use

This tab page cannot be used if the Reader/Writer is started in Safe Mode or SLAVE Mode. Use this tab page when the Reader/Writer is operating in Run Mode.

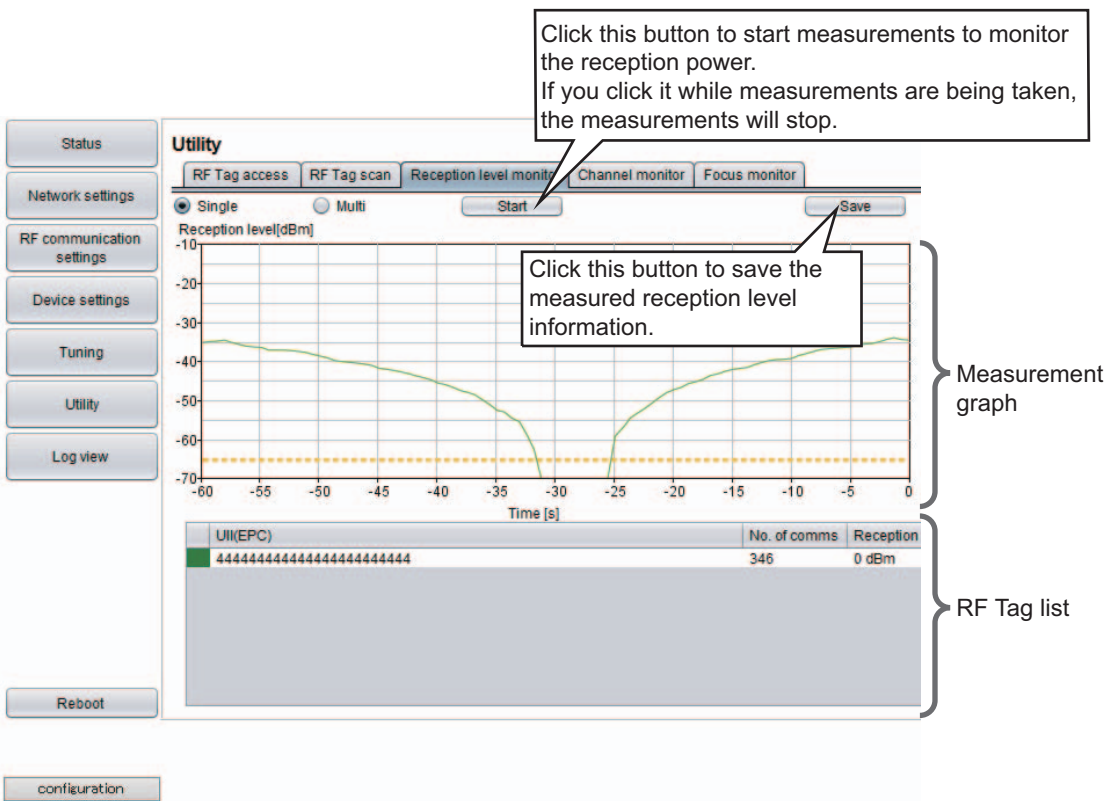

Item name	Description	Remarks
Single	Select this option to check the reception level for just one RF Tag.	
Multi	Select this option to check the reception level for more than one RF Tag.	
Measurement graph	This broken-line graph displays the reception level against time for each RF Tag during monitoring.	The data is plotted for 60 s.
RF Tag list	Ull (EPC)	This list displays the Ulls (EPC codes) of the RF Tags that were detected during monitoring.
	No. of comms	Displays the numbers of communications with the RF Tags during monitoring.
	Reception level	Displays the current reception levels measured during monitoring numerically and as a bar graph.

For information on reception level monitoring, refer to 6-9-3 *Reception Level Monitor* on page 6-50.

● **Saving Files**

You can click the **Save** Button on the Reception Level Monitor Tab Page to save the reception level monitoring information that was measured at a specified path and file name. The measurement results are saved in a CSV file in the following format.

<p>CSV Format</p> <p>No, Time, UII (EPC), Reception level[dBm]</p> <p>1 <time>, <UII (EPC code)>, <reception_level></p> <p>2 : : :</p>
--

Item name	Description	Remarks
No	Gives index numbers in chronological order. Single: 1 to 1,800 (100-ms sampling × 1,800 samples) Multi: 1 to 360 (500-ms sampling × 360 samples)	Data is output for up to 3 minutes.
Time	Displays the times of communications with the RF Tags during monitoring. hh:mm:ss.sss hh: hour, mm: minutes, ss.sss: seconds (millisecond increments)	The time is synchronized with the computer on which the Web browser is running.
UII (EPC)	Gives the UIIs (EPC codes) in hexadecimal of the RF Tags that were detected during monitoring. XX ... XX hex	
Reception level[dBm]	Gives the reception levels measured during monitoring. 0 or -1 to -99	The reception level will be 0 if a communications error occurs.

- Multiple Reader/Writers is enabled

The measurement results of the reception level monitor are saved in a CSV file in the following format with the Reader/Writer number attached.

The reception level trend can be checked for each Reader/Writer using the Excel filter function.

CSV Format

```
No, Time, R/W No, UII(EPC), Reception level[dBm]
1 <Time 1>, 0, <UII (EPC code)>, <Reception Level>
1 <Time 1>, 0, <UII (EPC code)>, <Reception Level> ← Result when measured with Reader/Writer 0 (2 RF tags)
1 <Time 1>, 0, <UII (EPC code)>, <Reception Level>
1 <Time 1>, 1, <UII (EPC code)>, <Reception Level> ← Result when measured with Reader/Writer 1 (1 RF tag)
1 <Time 1>, 1, <UII (EPC code)>, <Reception Level> ← Result when measured with Reader/Writer 2 (3 RF tags)
1 <Time 1>, 2, <UII (EPC code)>, <Reception Level>
1 <Time 1>, 2, <UII (EPC code)>, <Reception Level>
1 <Time 1>, 3, <UII (EPC code)>, <Reception Level> ← Result when measured with Reader/Writer 3 (2 RF tag)
1 <Time 1>, 3, <UII (EPC code)>, <Reception Level>
2 <Time 1>, 0, <UII (EPC code)>, <Reception Level>
: : : : :
```

* The number of saving item per one communications (the number of each index items) depend on the number of Reader/Writers and RF tags.

Item name	Description	Remarks
No	Gives index numbers in chronological order. Single: 1 to 1,800 (100-ms sampling × 1,800 samples) Multi: 1 to 360 (500-ms sampling × 360 samples)	Data is output for up to 3 minutes.
Time	Displays the times of communications with the RF Tags during monitoring. hh:mm:ss.sss hh: hour, mm: minutes, ss.sss: seconds (millisecond increments)	The time is synchronized with the computer on which the Web browser is running.
R/W No.	This gives the measured Reader/Writer number. 0 to 7	

Item name	Description	Remarks
UII (EPC)	Gives the UIIs (EPC codes) in hexadecimal of the RF Tags that were detected during monitoring. XX ... XX hex	
Reception level[dBm]	Gives the reception levels measured during monitoring. 0 or -1 to -99	The reception level will be 0 if a communications error occurs.



Precautions for Correct Use

To display Time in milliseconds in Excel, you need to change the display format of the cell.
Display format (user definition): "hh: mm: ss.000"

Channel Monitor

Click the **Utility** Button, and then click the **Channel monitor** Tab.

A tab page to monitor the noise level on each channel will be displayed. You can use this tab page to check the channels that are used by nearby Reader/Writers or to check the level of radio wave interference.

When the Multi-Reader/Writer function is enabled, it is possible to select the reader/writer subject to noise measurement.



Precautions for Correct Use

This tab page cannot be used if the Reader/Writer is started in Safe Mode or SLAVE Mode. Use this tab page when the Reader/Writer is operating in Run Mode.

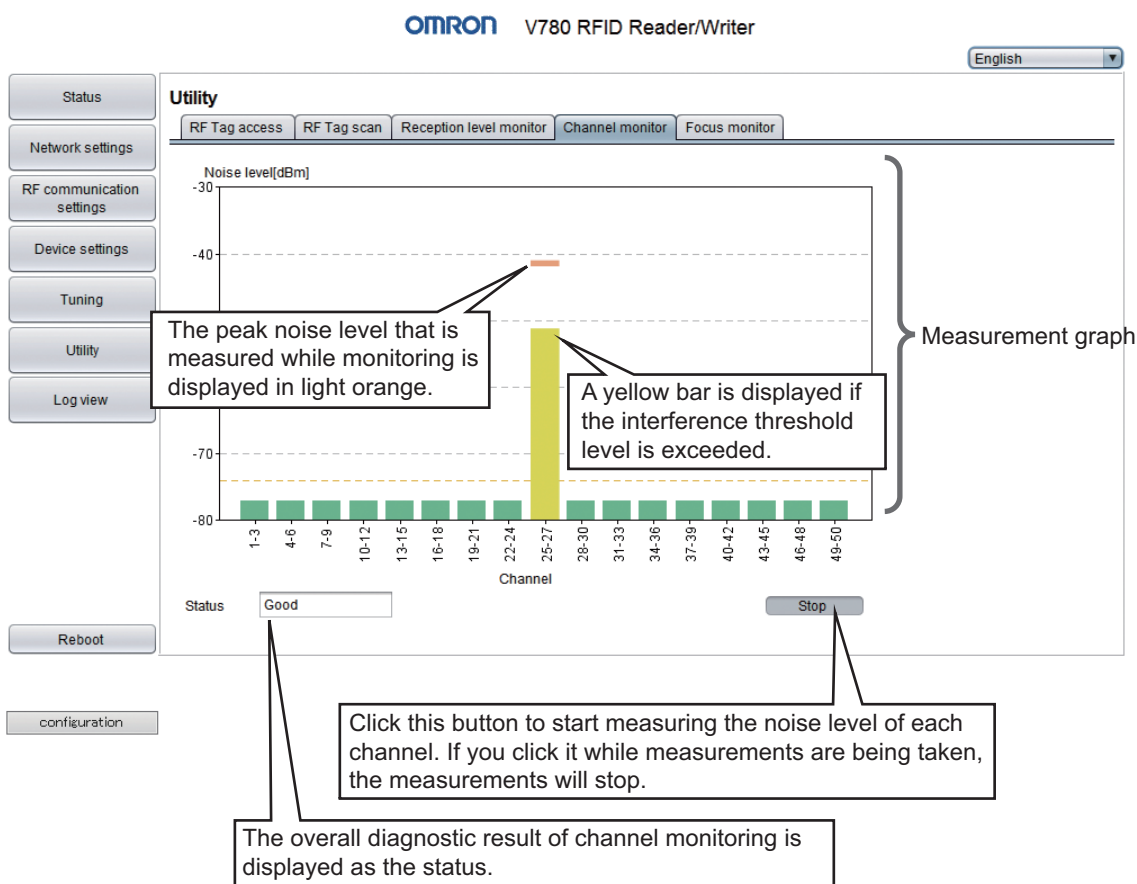

Note The channel monitor tab page depends on the model number.

Item name	Description	Remarks
Measurement graph	During monitoring, the noise level of each channel is displayed on a bar graph. The color of a bar is green if the noise level is smaller than -74 dBm and yellow if it is larger.	
Status	The diagnostic result of channel monitoring is displayed as "Good" or "Warning." If "Good" is displayed, the ambient noise environment is good. If "Warning" is displayed, there is too much interference.	

For information on channel monitoring, refer to 6-9-4 *Channel Monitor* on page 6-56.

Focus Monitor

Click the **Utility** Button, and then click the **Focus monitor** Tab.

A tab page to monitor the status when the Reader/Writer's Focus Mode is used will be displayed. You can use this tab page to check the target level indexes that determine which RF Tag is in front of the Reader/Writer.

Results of RF Tag monitoring are displayed for up to 64 RF Tags.



Precautions for Correct Use

This tab page cannot be used if the Reader/Writer is started in Safe Mode. Use this tab page when the Reader/Writer is operating in Run Mode.

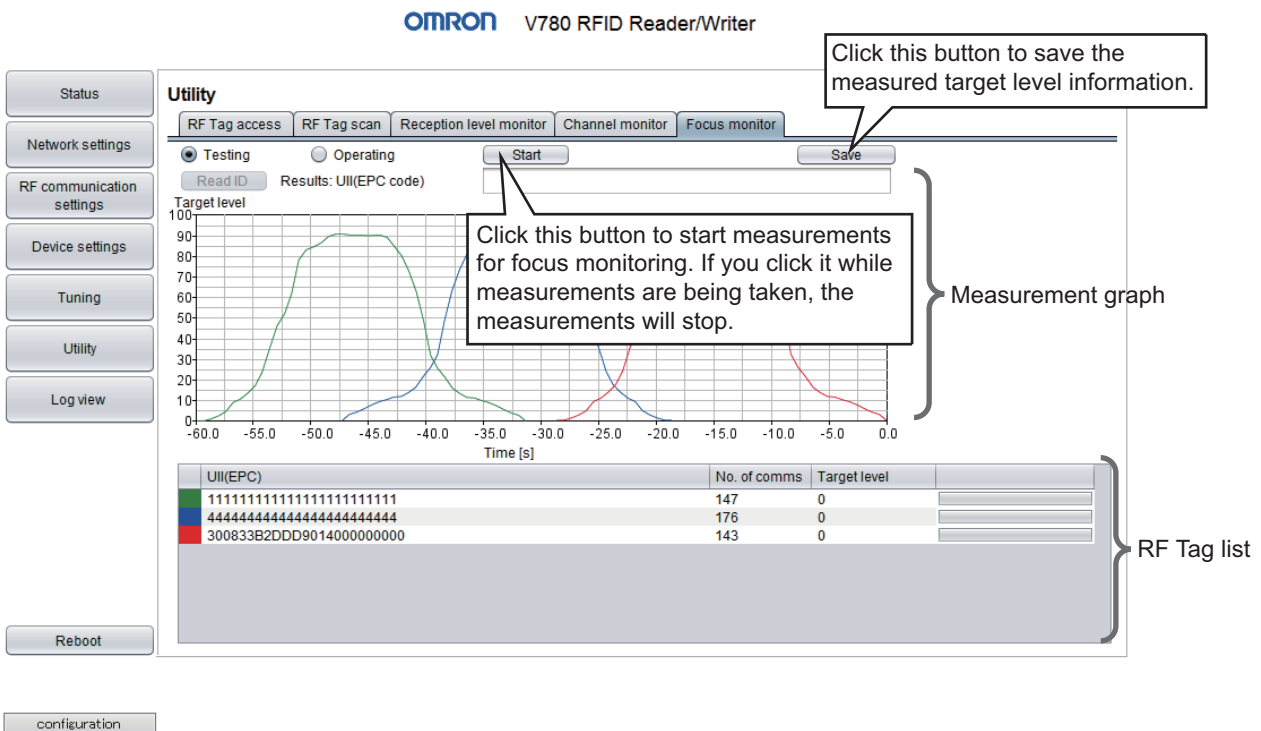

Item name	Description	Remarks
Testing	Select this option to test operation for communications in Focus Mode.	
Read ID	Click this button to execute test communications with ID READ during monitoring. When you click this button, the RF Tag with the highest target level on the right edge of the measurement graph will be selected as the RF Tag in front of the Reader/Writer.	
Result	The UII (EPC code) of the RF Tag that was communicated with is displayed as the result of test communications with ID READ. If communications failed, the background will change to red.	
Operating	Select this operation to check the target levels of the Reader/Writer during operation in Focus Mode.	
Measurement graph	This broken-line graph displays the target level against time for each RF Tag during monitoring.	The data is plotted for 60 s.
RF Tag list	UII (EPC code)	This list displays the UIIs (EPC codes) of the RF Tags that were detected during monitoring.
	No. of comms	Displays the numbers of communications with the RF Tags during monitoring.
	Target level	Displays the current target levels measured during monitoring numerically and as a bar graphs.

For information on focus monitoring, refer to *6-9-5 Focus Monitor* on page 6-57.

● Saving Files

You can click the **Save** Button on the Focus Monitor Tab Page to save the focus information at a specified path and file name. The focus information is saved in a CSV file in the following format.

CSV Format	
No, Time, UII (EPC), Target level	
1 <time>, <UII (EPC code)>, <target_level>	
2 <time>, <UII (EPC code)>, <target_level>	
3 <time>, <UII (EPC code)>, N/A (Test ID READ)	← This is displayed when testing communications with ID READ.
4 : : :	

Item name	Description	Remarks
No	Gives index numbers in chronological order. 1 to 360 (500-ms sampling × 360 samples)	Data is output for up to 3 minutes.
Time	Gives the time when the RF Tag target level was measured during monitoring. hh:mm:ss.sss hh: hour, mm: minutes, ss.sss: seconds (millisecond increments)	The time is synchronized with the computer on which the Web browser is running.
UII (EPC)	Gives the UIIs (EPC codes) of the RF Tags that were detected during monitoring in hexadecimal. XX ... XX hex	
Target level	Gives the target level measured during monitoring. 00 to 100: Target level When test communications with ID READ are performed, the following text is output. "N/A(Test ID READ)"	The target level for RF Tag what have already executed the RF communications command will be 0.

8-2-8 Logs

Command Error Log

Click the **Log view** Button, and then click the **Command error log** Tab.

The Command Error Log Tab Page will be displayed. You can check the command error information that was returned by the Reader/Writer. If you select one of the records in the list, details for the record will be displayed.

The screenshot shows the OMRON V780 RFID Reader/Writer web interface. On the left is a sidebar with buttons for Status, Network settings, RF communication settings, Device settings, Tuning, Utility, Log view, Reboot, and configuration. The main area is titled 'Log view' and has three tabs: 'Command error log', 'System error log', and 'RF communications diagnostics log'. The 'Command error log' tab is active, displaying a table with columns: No, Time, IP address, Transaction ID, Command, and Error name. The table contains three records, with the third record (No. 3, Time 0:00:09, IP 192.168.1.120, Transaction ID 0x0000, Command Unknown com..., Error name RF Tag missing error) highlighted. Below the table, the details for record 3 are shown: No. 3, Command 0xF021: Unknown command, Error name 0x2001: RF Tag missing error, Additional info 1 00000000, and Additional info 2 00000000. A message states: 'There is no RF Tag in the communications range.' An 'Update' button is located below the details. A callout box points to the 'Update' button with the text: 'Click this button to refresh the display.'

Item name	Description	Remarks
No.	Displays the log record number. The lower numbers are assigned to the most recent records.	
Time	Time	
IP address	Displays the IP address of the host device that sent the command.	
Command name	Displays the command code and command name of the command received by the Reader/Writer.	
Error name	Displays the error name and error code.	For details, refer to 9-3 Errors and Countermeasures on page 9-8.
Additional info 1	Display codes that provide supplemental error information.	
Additional info 2		

For details on the command error log, refer to 9-2-1 Command Errors on page 9-4.

System Error Log

Click the **Log view** Button, and then click the **System error log** Tab.

The System Error Log Tab Page will be displayed. You can check the system error information that was detected by the Reader/Writer. If you select one of the records in the list, details for the record will be displayed.

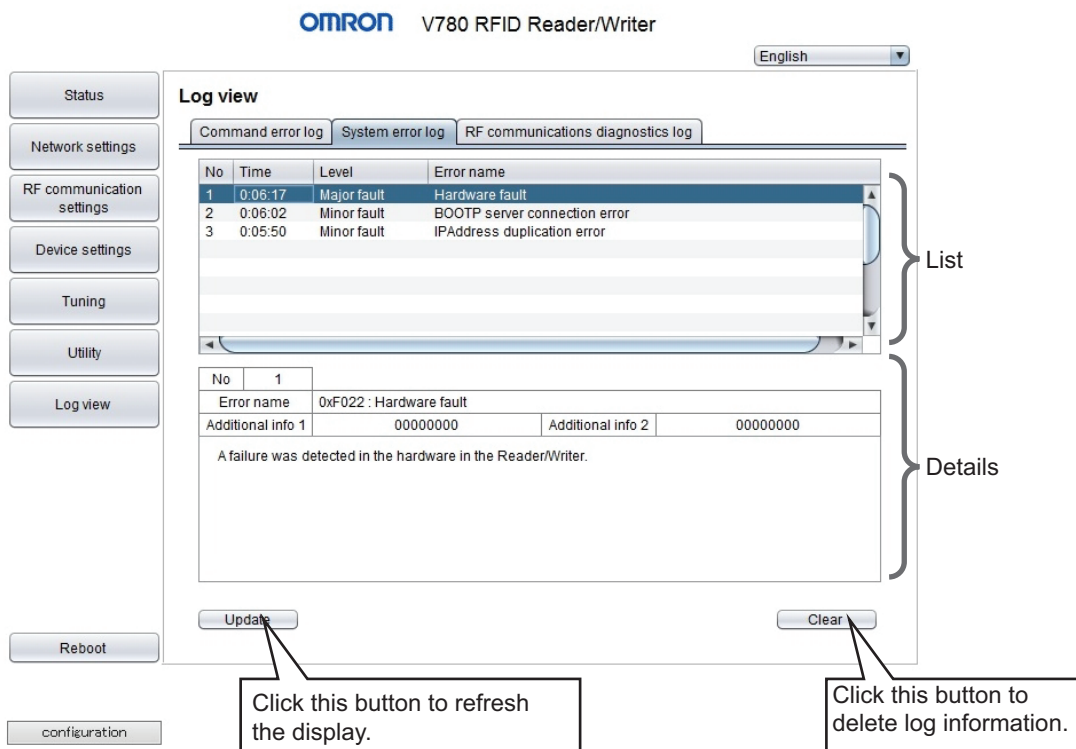

Item name	Description	Remarks
No.	Displays the log record number. The lower numbers are assigned to the most recent records.	
Time	Displays the time when the system error was detected by the Reader/Writer.	
Level	Displays the level of the system error as follows: Minor fault or Major fault	
Error name	Displays the error code and error name.	For details, refer to 9-3 Errors and Countermeasures on page 9-8.
Additional info 1	Display codes that provide supplemental error information.	
Additional info 2		

For details on the system error log, refer to 9-2-1 Command Errors on page 9-4.

RF Communications Diagnostics Log

Click the **Log view** Button, and then click the **RF communications diagnostics log** Tab.

The Communications Diagnostics Log Tab Page will be displayed. You can use this tab page to check the results of RF communications diagnostics.



Precautions for Correct Use

This tab page cannot be used if the Reader/Writer is started in Safe Mode. Use this tab page when the Reader/Writer is operating in Run Mode.

● Communications Diagnostic Information Display

If you select one of the records in the list, details for the record will be displayed.

OMRON V780 RFID Reader/Writer

English

Status

Network settings

RF communication settings

Device settings

Tuning

Utility

Log view

Reboot

configuration

Log view

Command error log System error log **RF communications diagnostics log**

Total: 100 Warning: 5 Error: 6 Graph

No	Time	Command	Result	Diagnostics result	UID(EPC)
1	0:2:43	ID read	Normal	Normal	1234567E
2	0:3:29	ID read	Warning	Insufficient power to receive	1234567E
3	0:3:42	ID read	Warning	Too much noise	1234567E
4	0:3:50	ID read	Error	RF Tag missing error	1234567E
5	0:4:46	ID read	Normal	Normal	1234567E
6	0:4:47	ID read	Normal	Normal	1234567E
7	0:4:47	ID read	Normal	Normal	1234567E
8	0:4:48	ID read	Normal	Normal	1234567E

No: 2

Command: 0001: ID read

Diagnostics result: 0002: Insufficient power to receive

Diagnostics details	0x0002	Reception level	-50dBm	Noise level	-77dBm
Used channel	10	RF speed	High speed	Target level	0

The strength of the signal returned from the RF Tag to the Reader/Writer was weak.

[Probable cause/Workaround]

1

Update
Save
Clear

List

Details

Click this button to save the record information displayed in the RF communications diagnostic information log.

Click this button to get the most recent record information in the RF communication diagnostics log from the Reader/Writer and refresh the display.

Click this button to delete the RF communications log information in the Reader/Writer.

Item name	Description	Remarks
No.	Displays the log record number. The lower numbers are assigned to the most recent records.	
Time	Displays the time when the Reader/Writer executed the RF communications command.	
Command	Displays the command code and command name of the command executed by the Reader/Writer.	
Result	Displays the execution result for the RF communications command. Normal (normal communications), Warning (unstable communications), or Error (communications error)	
Diagnostic result	“Normal” will be displayed if the RF communications result was Normal. The communications result and diagnosis code will be displayed if the communications result was Warning. The error code and error name will be displayed if the communications result was Error.	
UII (EPC)	Displays the UIIs (EPC codes) of the RF Tags that were detected in communications diagnostics.	
Diagnostic details	Displays all diagnostic results detection status as bit information in four hexadecimal digits.	
Reception level	Displays the reception level measured during communications diagnostics.	
Noise level	Displays the noise level measured during communications diagnostics.	
Channel	Displays the channel that the Reader/Writer communicated with the RF Tag.	
RF communications speed	Displays the communications speed that the Reader/Writer communicated with the RF Tag.	
Target level	Displays the target level measured during communications diagnostics.	
Probable Cause and Workaround	Displays the probable causes and workarounds for unstable communications.	

For details on the RF communications diagnostics log, refer to *9-2-1 Command Errors* on page 9-4.

● **Communications Diagnostic Information Graph Display**

Click the **Graph** Button on the display of RF communications diagnostics information to display the Graph View. The RF communications diagnostics information will be displayed on a bar graph against time so that you can quantitatively check the leeway in communications.

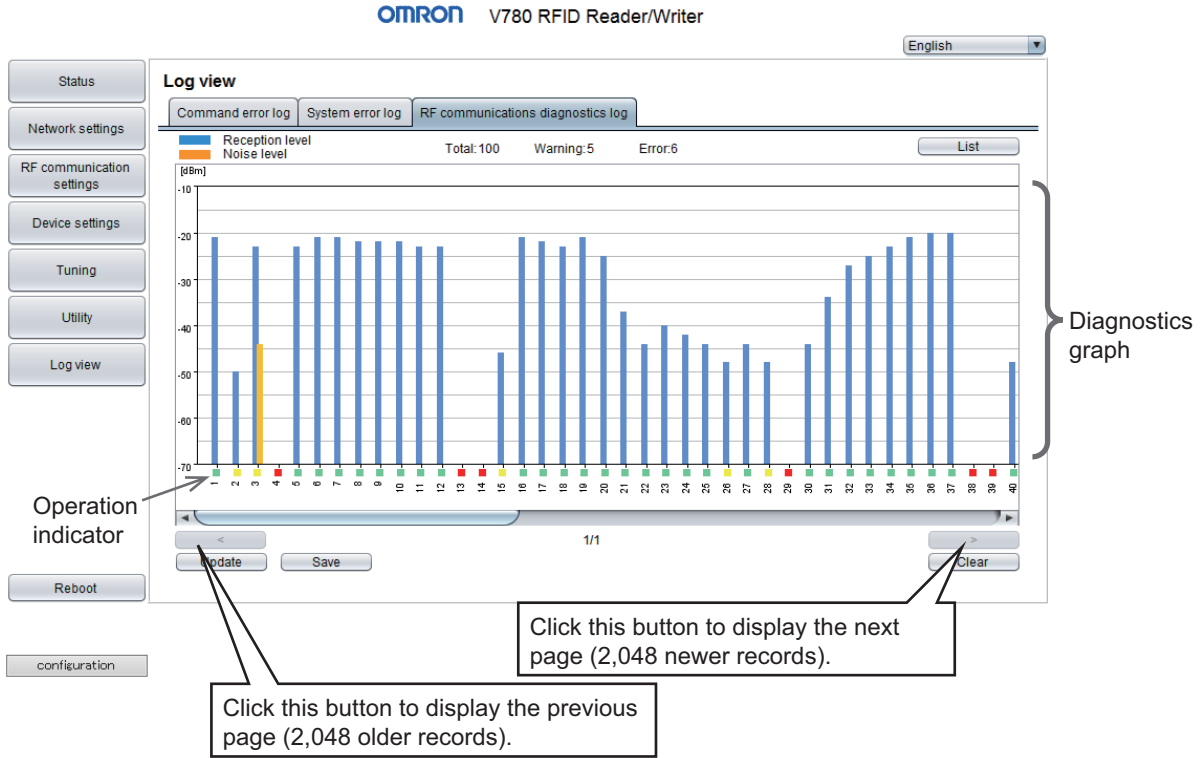

Item name		Description	Remarks
Diagnosis graph	Reception level	Displays the reception level from RF communications diagnostics with a blue bar.	
	Noise level	Displays the noise level from RF communications diagnostics with an orange bar.	
	Operation indicator	Displays the operation indicator color for RF communications diagnostics as green, yellow, or red.	These colors will not change even if you set operation indicator custom colors. They will display the default lighting colors.

For details on the RF communications diagnostics log, refer to 9-2-1 *Command Errors* on page 9-4.

● Saving Files

You can click the **Save** Button on the RF Communications Diagnostics Log Tab Page to save the RF communications diagnostics log at a specified path and file name. The RF communications diagnostics log information is saved in a CSV file in the following format.

CSV Format	
No, Time, Command, Result, Diagnostics result, Diagnostic details, Reception level[dBm], Noise level[dBm], UII (EPC)	
1	<time>, <command_name>, <RF_communications_result>, <diagnostic_result>, <diagnostic_details>, <reception_level>, <noise_level>, <UUI (EPC code)>
2	:
Total, XX	
Warning, YY	
Error, ZZ	

Item name	Description	Remarks
No	Gives the log record number. 1 to 8192	
Time	Gives the time when the Reader/Writer executed the RF communications command. hh:mm:ss hh: hour, mm: minutes, ss: seconds (second increments)	
Command	Gives the name of the command that was executed by the Reader/Writer. "Command name text"	
Result	Gives the execution result for the RF communications command. Normal: Normal communications Warning: Unstable communications Error: Communications error	
Diagnostics result	Gives the communications diagnostic results. Normal Insufficient power to send Insufficient power to receive Too much noise Insufficient read data Excessive read data Error name text: RF Tag communications error name	
Diagnostic details	Gives all diagnostic results detection status as bit information in four hexadecimal digits. XXXX hex	
Reception level[dBm]	Gives the reception level measured during communications diagnostics. 0 or -1 to -99	The level will be 0 if the result is Error.
Noise level[dBm]	Gives the noise level measured during communications diagnostics. 0 or -1 to -99	
Channel	Displays the channel that the Reader/Writer communicated with the RF Tag.	
RF communications speed	Displays the communications speed that the Reader/Writer communicated with the RF Tag.	
Target level	Displays the target level measured during communications diagnostics.	
UUI (EPC)	Gives the UIIs (EPC codes) of the RF Tags that were detected during RF communications diagnostics in hexadecimal. XX ... XX hex	
Total	Gives the total number of log records in decimal.	
Error	Gives the number of communications errors in the log in decimal.	
Warning	Gives the number of unstable communications in the log in decimal.	

8-2-9 Rebooting

When network settings have been changed and you click the **Reboot** Button on one of the displays, the Reader/Writer will be restarted and the changes to the setting will be applied.

If you click the **Reboot** Button, a Confirm Reboot Dialog Box will be displayed.

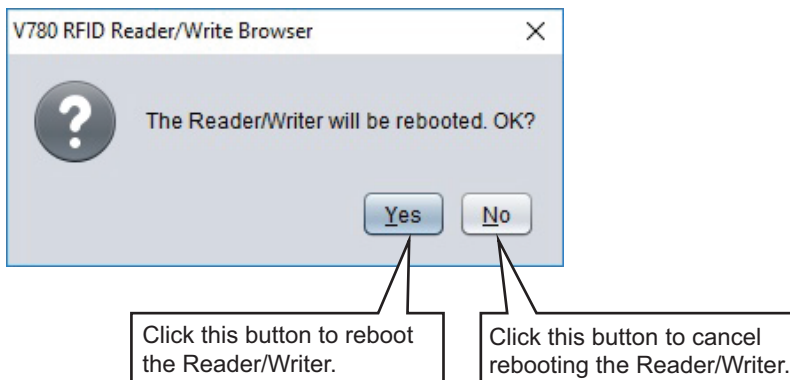

The following dialog box is displayed after the Reader/Writer has finished rebooting.

Click the **Yes** Button to connect to the Reader/Writer.

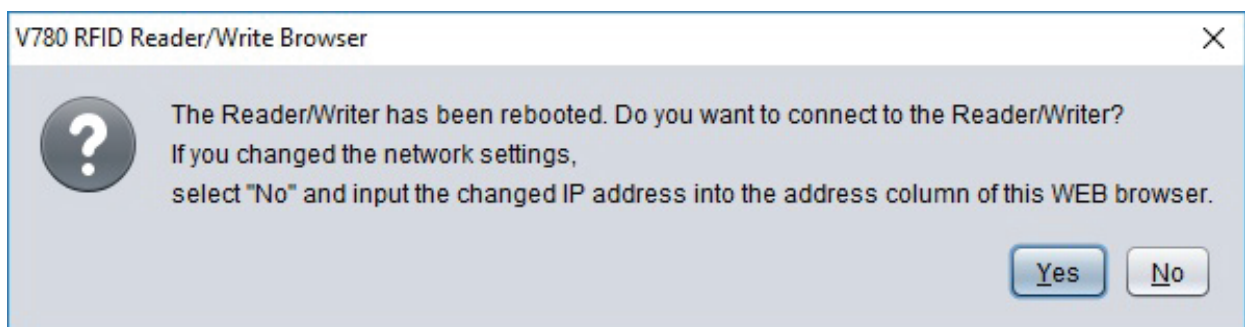

The following dialog box is displayed after reconnecting to the Reader/Writer. Click the **OK** Button.

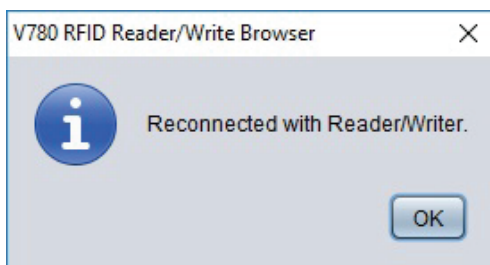

Precautions for Correct Use

If reconnection fails and an error is displayed, check the connection with the Reader/Writer and restart your browser.

8-2-10 Configuration

You can save a configuration file (INI file) that contains the configuration information from the Reader/Writer in the computer. You can also send a configuration file to the Reader/Writer to change all of the configuration information in the Reader/Writer. Click the **Default** Button to return the settings in the Reader/Writer to the default settings.

To display the Configuration View, click the **Configuration** Button at the bottom of the Browser Operation Interface.

You can click the **Status** Button at the bottom left of the Configuration View to return to the original status.

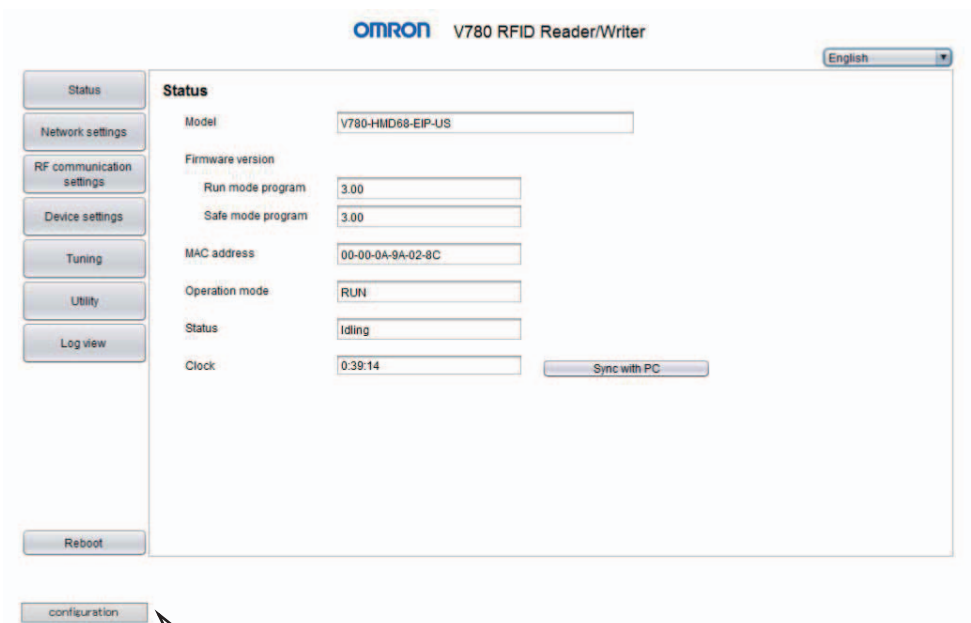

Click this button to display the Configuration View.

Click the **Configuration** Button to display the Configuration View.



V780 RFID Reader/Writer

Export Configuration File to PC

Import Configuration File to R/W

Initialize Configuration

Status

Item name	Description
Export Configuration File to PC	Saves a configuration file that contains the Reader/Writer settings on the computer.
Import Configuration File to R/W	Updates the settings in the Reader/Writer with the settings in a configuration file that you specify on the computer.
Initialize Configuration	Returns all of the settings in the Reader/Writer to the default settings.

Saving a Configuration File on the Computer

You can click the **Export** Button in the Export Configuration File to PC Area to save a configuration file (file name: conf.ini) that contains the configuration information from the Reader/Writer on the computer. The configuration file uses a normal INI file format.

Export Configuration File to PC

Click the **Export** Button. The following dialog box will be displayed. Click the **Save** Button.

Do you want to open or save **conf.ini** (856 bytes) from 192.168.1.200?

The following Security Warning Dialog Box will be displayed. Click the **Allow** Button.

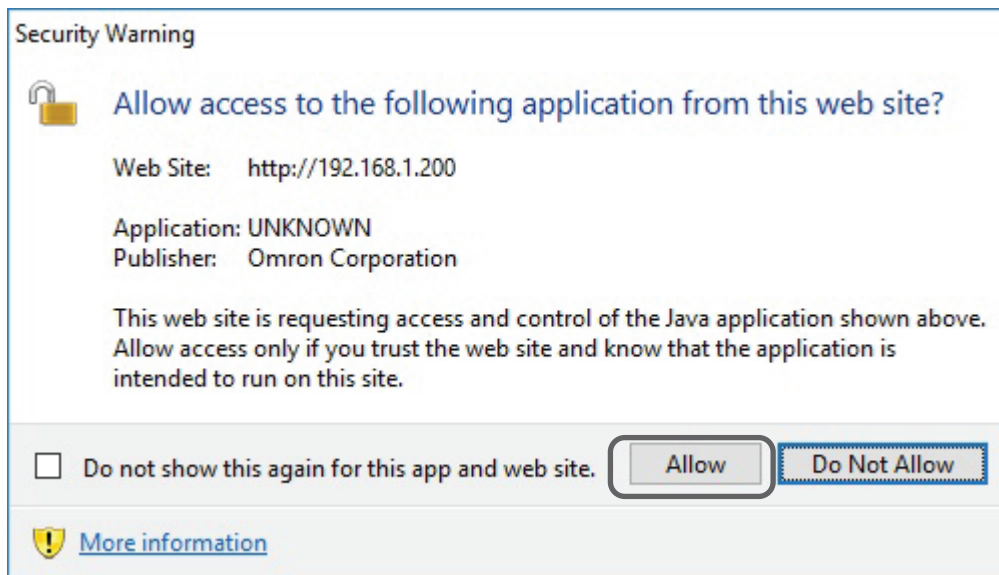

When the configuration file has been saved (file name: conf.ini), the following dialog box will be displayed. Click the **Open folder** Button to display the folder in which the configuration file was saved.

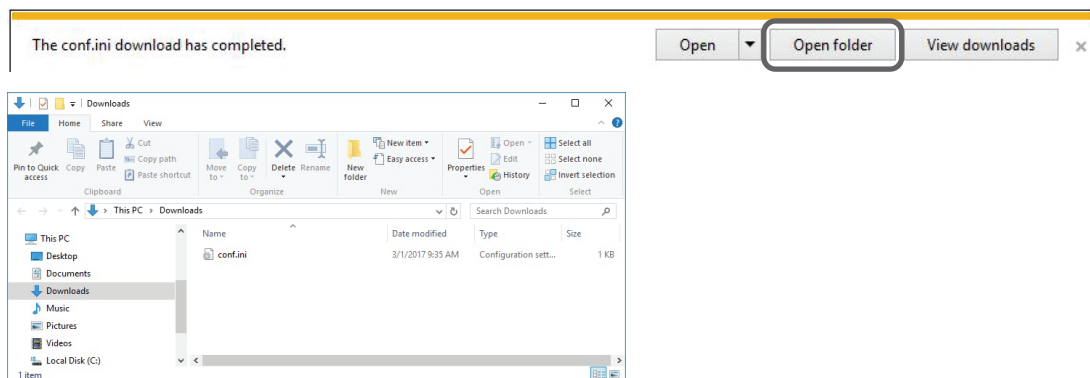

Loading a Configuration File to the Reader/Writer

You can change all of the configuration information in the Reader/Writer with the following procedure: Click the **Browse** Button in the Import Configuration File to R/W Area, select the configuration file to use to set up the Reader/Writer, and then click the **Import** Button.

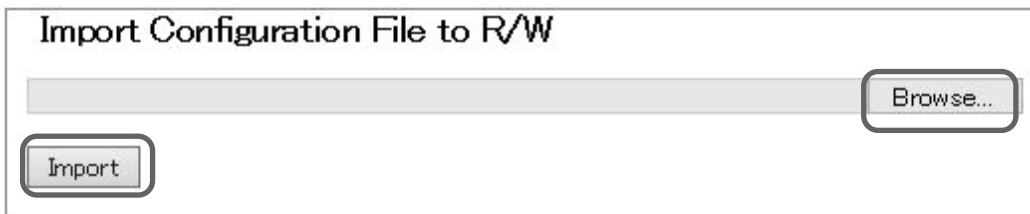

Click the **Browse** Button. A dialog box to select the configuration file will be displayed. Select the configuration file and then click the **Open** Button.

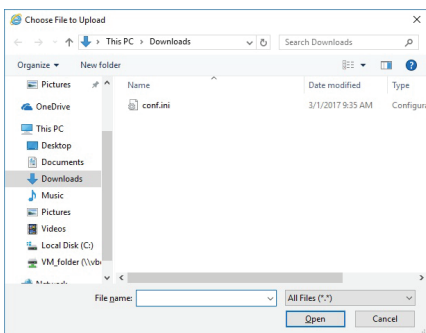

Click the **Import** Button. All of the configuration information in the Reader/Writer will be changed.



Click the **Return** Button to display the Configuration View.

OMRON V780 RFID Reader/Writer

Export Configuration File to PC

Import Configuration File to R/W

Initialize Configuration

Restoring the Default Settings

Click the **Default** Button in the Initialize Configuration Area to return all of the settings in the Reader/Writer to the default settings. After you initialize the settings, cycle the power supply to the Reader/Writer to enable the new settings.



Click the **Default** Button in the Initialize Configuration Area. The following dialog box will be displayed. Click the **OK** Button.

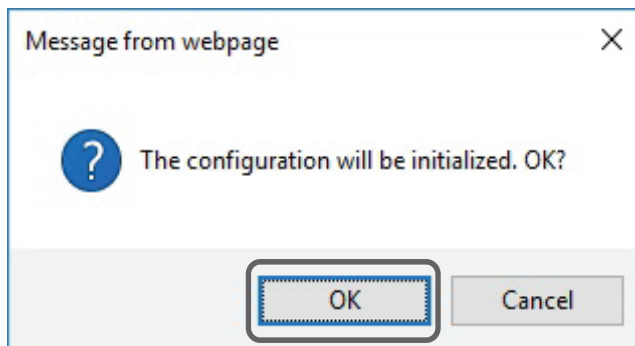

8-2-11 Configuration File

This section describes the format of the configuration file. The configuration file uses a normal INI file format.

- Any line that starts with a semicolon (;) is treated as a comment.
- Any line that starts with an opening bracket ([) is treated as a section declaration row. The row must also end in a closing bracket (]).
- Any row that does not start with either of the above two characters is an entry row.

Section and Entry Table

Section name	Entry name	Description	Default
NetworkSetting	IPAddressSetting Method	Gives the IP address setting method for the Reader/Writer. Specify a decimal value. 0000: Fixed setting 0001: Obtain from BOOTP server 0002: Get from BOOTP server as fixed settings	0000
	IPAddress	Gives the setting of the IP address of the Reader/Writer. It is given as four decimal numbers separated by periods.	192.168.1.200
	SubnetMask	Gives the setting of the subnet mask of the Reader/Writer. It is given as four decimal numbers separated by periods.	255.255.255.0
	GatewayAddress	Gives the setting of the default gateway of the Reader/Writer. It is given as four decimal numbers separated by periods.	192.168.1.254
	DeviceName	Gives the name of the Reader/Writer. It is given in up to 63 ASCII characters.	(Not set.)
	WebPort	Gives the Ethernet communications port number for the browser interface. It is set to 1024 to 65535 decimal.	7090
	WebPassword	Gives the login password for the browser interface. It is specified in up to 15 ASCII characters. "" (blank) is specified for no password.	(Not set.)
RFCommunication-Setting	RFCommunication Mode	Gives the RF communications mode setting. It is specified as a decimal value. 0: Once 1: Auto 2: Focus 3: Repeat	0
	RFCommunication Speed	Gives the communications speed between the Reader/Writer and RF Tags. It is specified as a decimal value. 0: Auto speed 1: High speed 2: Normal speed	0
	RFCommunication Timeout	Gives the RF communications timeout time. It is specified as a decimal value.	250

Section name	Entry name	Description	Default
RFCommunication-Setting	WriteVerify	Gives the setting for write verification for write communications. Either “true” or “false” is specified. true: Verification used. false: Verification not used.	true
	RFCommunicationDiagnostics	Gives the enable/disable setting for RF communications diagnostics. It is set to true or false. true: Enable false: Disable	false
RFCommunication-AdvanceSetting	ReadTransmissionPower	Gives the transmission power setting for read RF communications commands. It is specified as a decimal value. 15 to 27: 15 to 27 dBm	27
	WriteTransmissionPower	Gives the transmission power setting for write RF communications commands. It is specified as a decimal value. 15 to 27: 15 to 27 dBm	27
	Channel	Gives the channel setting. It is specified as a decimal value. *1. You can specify the value depending on the model number. For details, refer to <i>Channel</i> on page 6-27 under <i>6-4-3 RF Communications Conditions: Advanced Settings</i> on page 6-26.	0
	Gen2Session	Gives the setting of the Gen2 session. It is specified as a decimal value. 0 to 3: S0 to S3	0
	AccessPassword	Gives the access password for RF Tag communications. It is specified in eight hexadecimal digits. A setting of 00000000 is treated as no password setting.	00000000
	ContinuousTime	Gives the setting of the continuous transmission time. It is specified as a decimal value. *1. You can specify the value depending on the model number. For details, refer to <i>Transmission Time</i> on page 6-29 under <i>6-4-3 RF Communications Conditions: Advanced Settings</i> on page 6-26.	*1. You can specify the value depending on the model number. For details, refer to <i>Transmission Time</i> on page 6-29 under <i>6-4-3 RF Communications Conditions: Advanced Settings</i> on page 6-26.
	StopTime	Gives the setting of the stop time. It is specified as a decimal value. *1. You can specify the value depending on the model number. For details, refer to <i>Transmission Time</i> on page 6-29 under <i>6-4-3 RF Communications Conditions: Advanced Settings</i> on page 6-26.	

Section name	Entry name	Description	Default
RFCommunication-AdvanceSetting	RSSIFilterEnable	Gives the enable/disable setting of the RSSI filter. It is set to true or false. true: Enable false: Disable	false
	RSSIFilterHighThreshold	Gives the setting of the high threshold for the RSSI filter. It is set to 0 or from -10 to -70 decimal.	0
	RSSIFilterLowThreshold	Gives the setting of the low threshold for the RSSI filter. It is set to 0 or from -10 to -70 decimal.	0
	RFTagSelectFilterEnable	Gives the enable/disable setting of the RF Tag selection filter. It is set to true or false. true: Enable false: Disable	false
	RFTagSelectFilterMemoryAddress1	Gives the memory address setting for the RF Tag selection filter. It is specified in four hexadecimal digits.	0000
	RFTagSelectFilterSize1	Gives the setting of the data length in words for the RF Tag selection filter. It is set to 0 to 16 decimal.	0
	RFTagSelectFilterVerificationData1	Gives the setting of the verification data for the RF Tag selection filter. It is specified in 64 hexadecimal digits (16 words).	00...00
	Smoothing BufferRegistrationNumber	This is the number of smoothing buffer when the communication mode is set to repeat. It must be specified as a decimal number.	1024
DeviceSetting	LEDCustomNormal	Gives the custom indicator setting for a normal command (NORM). It is set to -1 (not lit) or from 1 to 7 (individual colors) decimal.	1 (green)
	LEDCustomError	Gives the custom indicator setting for a command error (ERROR). It is set to -1 (not lit) or from 1 to 7 (individual colors) decimal.	2 (red)
	LEDCustomWarning	Gives the custom indicator setting for unstable communications (WARNING). It is set to -1 (not lit) or from 1 to 7 (individual colors) decimal.	3 (yellow)

Section name	Entry name	Description	Default
Multi-ReaderWriter-Setting	Multi-ReaderWriter Mode	This is the Multi-Reader/Writer setting. It is given as a decimal value. 0: Disabled 1: Enabled (Communications range expansion mode)	0
	NumberOfSlave ReaderWriters	This is the number of connected slave Reader/Writers. It is given as a decimal value. 1 to 7	0
	SlaveReaderWriter1_IPAddress	This is the fixed IP address setting of slave Reader/Writer 1. It is given as four decimal numbers separated by periods.	0.0.0.0
	SlaveReaderWriter2_IPAddress	This is the fixed IP address setting of slave Reader/Writer 2. It is given as four decimal numbers separated by periods.	0.0.0.0
	SlaveReaderWriter3_IPAddress	This is the fixed IP address setting of slave Reader/Writer 3. It is given as four decimal numbers separated by periods.	0.0.0.0
	SlaveReaderWriter4_IPAddress	This is the fixed IP address setting of slave Reader/Writer 4. It is given as four decimal numbers separated by periods.	0.0.0.0
	SlaveReaderWriter5_IPAddress	This is the fixed IP address setting of slave Reader/Writer 5. It is given as four decimal numbers separated by periods.	0.0.0.0
	SlaveReaderWriter6_IPAddress	This is the fixed IP address setting of slave Reader/Writer 6. It is given as four decimal numbers separated by periods.	0.0.0.0
	SlaveReaderWriter7_IPAddress	This is the fixed IP address setting of slave Reader/Writer 7. It is given as four decimal numbers separated by periods.	0.0.0.0
	SlaveReaderWriter1_ReadTransmission Power	This is the transmission power setting for communications commands of the slave Reader/Writer 1 read system. It is given as a decimal value. 15 to 27: 15 to 27 dBm	27
	SlaveReaderWriter1_WriteTransmission Power	This is the transmission power setting for communications commands of the slave Reader/Writer 1 write system. It is given as a decimal value. 15 to 27: 15 to 27 dBm	27
	SlaveReaderWriter2_ReadTransmission Power	This is the transmission power setting for communications commands of the slave Reader/Writer 2 read system. It is given as a decimal value. 15 to 27: 15 to 27 dBm	27
	SlaveReaderWriter2_WriteTransmission Power	This is the transmission power setting for communications commands of the slave Reader/Writer 2 write system. It is given as a decimal value. 15 to 27: 15 to 27 dBm	27
	SlaveReaderWriter3_ReadTransmission Power	This is the transmission power setting for communications commands of the slave Reader/Writer 3 read system. It is given as a decimal value. 15 to 27: 15 to 27 dBm	27

Section name	Entry name	Description	Default
Multi-ReaderWriter-Setting	SlaveReaderWriter3_WriteTransmission Power	This is the transmission power setting for communications commands of the slave Reader/Writer 3 write system. It is given as a decimal value. 15 to 27: 15 to 27 dBm	27
	SlaveReaderWriter4_ReadTransmission Power	This is the transmission power setting for communications commands of the slave Reader/Writer 4 read system. It is given as a decimal value. 15 to 27: 15 to 27 dBm	27
	SlaveReaderWriter4_WriteTransmission Power	This is the transmission power setting for communications commands of the slave Reader/Writer 4 write system. It is given as a decimal value. 15 to 27: 15 to 27 dBm	27
	SlaveReaderWriter5_ReadTransmission Power	This is the transmission power setting for communications commands of the slave Reader/Writer 5 read system. It is given as a decimal value. 15 to 27: 15 to 27 dBm	27
	SlaveReaderWriter5_WriteTransmission Power	This is the transmission power setting for communications commands of the slave Reader/Writer 5 write system. It is given as a decimal value. 15 to 27: 15 to 27 dBm	27
	SlaveReaderWriter6_ReadTransmission Power	This is the transmission power setting for communications commands of the slave Reader/Writer 6 read system. It is given as a decimal value. 15 to 27: 15 to 27 dBm	27
	SlaveReaderWriter6_WriteTransmission Power	This is the transmission power setting for communications commands of the slave Reader/Writer 6 write system. It is given as a decimal value. 15 to 27: 15 to 27 dBm	27
	SlaveReaderWriter7_ReadTransmission Power	This is the transmission power setting for communications commands of the slave Reader/Writer 7 read system. It is given as a decimal value. 15 to 27: 15 to 27 dBm	27
	SlaveReaderWriter7_WriteTransmission Power	This is the transmission power setting for communications commands of the slave Reader/Writer 7 write system. It is given as a decimal value. 15 to 27: 15 to 27 dBm	27

9

Troubleshooting

This section describes the types of errors that can occur for V780 Reader/Writers, how to check for errors, and how to correct errors.

9-1	Types of Errors	9-2
9-1-1	Errors Indicated on Operation Indicators	9-2
9-1-2	Errors Indicated with Error Codes	9-3
9-2	Error Tables	9-4
9-2-1	Command Errors	9-4
9-2-2	System Errors	9-6
9-2-3	WDT Errors	9-7
9-3	Errors and Countermeasures	9-8
9-3-1	Command Errors	9-8
9-3-2	RF Tag Communications Error	9-10
9-3-3	Minor Fault	9-14
9-3-4	Major Fault	9-17
9-3-5	WDT Error	9-17
9-4	Cannot Display the Web Browser Operation Window	9-18
9-4-1	Problem	9-18
9-4-2	Solution	9-19
9-4-3	Java installation	9-20
9-4-4	Java Security Settings	9-21
9-4-5	Java Security Settings Are Not Displayed	9-22
9-4-6	Register Trusted Site	9-23
9-4-7	Countermeasures for Other Problems	9-24

9-1 Types of Errors

The Reader/Writer indicates errors in the following ways.

- Errors are indicated on the operation indicators.
- Errors are indicated with error codes.

9-1-1 Errors Indicated on Operation Indicators

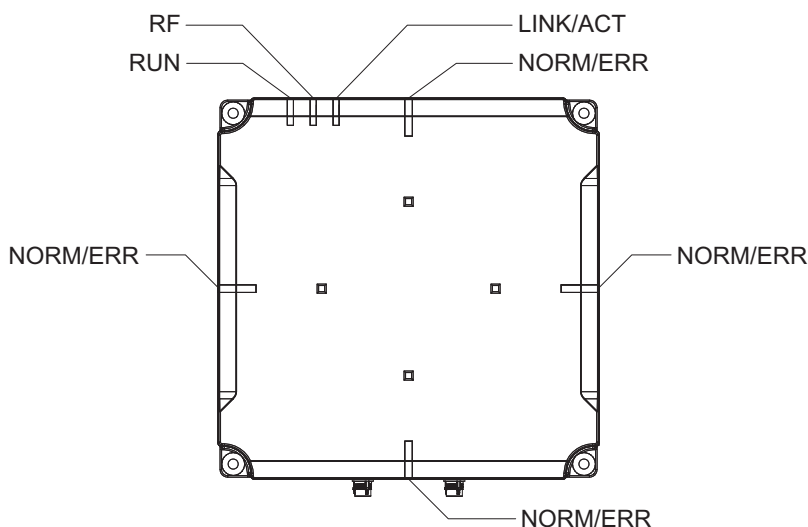

Reader/Writer operating status		Operation indicators			Execution of RF Tag communications	Communications connection to the host device
		RUN (green)	NORM/ERR (red)	NORM/ERR (yellow)		
Running		Flashing at 0.1-s intervals	Not lit	---	Not possible	Not possible
Normal operation	Run Mode	Lit	Not lit	---	Possible	Possible
	Safe Mode	Flashing at 0.4-s intervals	Not lit	---	Not possible	Possible
	SLAVE Mode	Lit	Not lit	---	Not possible	Not possible
Errors for which the Reader/Writer will not operate	WDT error	Not lit	Lit	---	Not possible	Not possible
	IP address conflict	Flashing at 0.1-s intervals	Flashing irregularly twice	---	Not possible	Not possible
	BOOTP server connection error	Flashing at 0.1-s intervals	Flashing irregularly twice	---	Not possible	Not possible
	Tag data link timeout	Lit	---	Flashing at 0.1-s intervals	Not possible	Not possible
Errors for which the Reader/Writer will operate	Command error	Lit	Flashes once	---	Possible	Possible
	RF Tag communications error	Lit	Flashes once	---	Possible	Possible
	Minor fault	Lit (See note.)	Flashing at 0.4-s intervals	---	Not possible	Possible
	Major fault	Lit (See note.)	Lit	---	Not possible	Possible

Note If these errors are detected during operation, the RUN indicator will flash at 0.4-s intervals.

9-1-2 Errors Indicated with Error Codes

Type		Description
Command errors	Command error	Errors related to command input or execution
	RF Tag communications error	Errors related to communications with RF Tags
System errors	Minor fault	Errors related to Reader/Writer settings or operation
	Major fault	Errors related to hardware

9-2 Error Tables

You can use the error code (4-digit hexadecimal value) to identify the error that was detected by the Reader/Writer.

Error codes are part of the information that is recorded in the command error log or system error log.

9-2-1 Command Errors

There are two types of command errors, command errors related to command input or execution and RF Tag communications errors related to communications with RF Tags. Command errors are recorded in the command error log when the response for command execution is returned.

Command Errors

Error name	Error code	Description
Unknown command error	1003 hex	A command that is not supported was received.
Command parameter error (Reserved)	1005 hex ---	There was an error in the parameters of the received command.
Command execution failure, busy	1011 hex	The Reader/Writer was executing another command and could not execute the received command.
Command execution failure (inappropriate operation mode)	1012 hex	The received command cannot be executed in the current operation mode of the Reader/Writer.
Command execution failure (inappropriate RF communications mode) (Reserved)	1013 hex ---	The received command cannot be executed in the current RF communications mode of the Reader/Writer.
Command execution failure, minor fault (Reserved)	1018 hex ---	There was a minor fault system error in the Reader/Writer and the Reader/Writer could not execute the received command.
Command execution failure, major fault	101F hex	There was a major fault system error in the Reader/Writer and the Reader/Writer could not execute the received command.

RF Tag Communications Errors

Error name	Error code	Description
RF Tag missing error ^{*1}	2001 hex	There is no RF Tag in the communications range.
RF Tag communications failed ^{*1}	2002 hex	Communications with the RF Tag did not end normally.
RF Tag address error	2004 hex	The access address for the RF Tag is outside of the area supported by the target RF Tag.
RF Tag lock error	2005 hex	Access to an area that is locked in the RF Tag failed.
RF Tag verification error	2006 hex	Verification was performed for the results of writing data to the RF Tag, but inconsistencies were discovered.
RF Tag system error	2008 hex	The RF Tag returned an error response.
Password error	2009 hex	The access password does not match the RF Tag. ^{*2}
Communications error between Reader/Writers	200B hex	The master Reader/Writer will establish communications with the slave Reader/Writers during execution of the Multi-Reader/Writer function.
Communications canceled	2011 hex	Processing was canceled when a STOP command was received before an RF Tag was detected. (The contents of the RF Tag was not changed, even for a DATA WRITE command.)
Communications aborted	2012 hex	Processing was aborted when a STOP command was received during communications with an RF Tag.

*1. Due to the surrounding environment, the intended RF tag may not be readable if the transmission power output is overly strong.

*2. When the environment is unstable, this error can occur even if the access password is correct.

9-2-2 System Errors

There are mainly two types of system errors, minor faults related to Reader/Writer settings or operation and major faults related to hardware. System errors are recorded in the system error log when they are detected by Reader/Writer self-diagnostic processing.

Minor Faults

Error name	Error code	Description
Unfixed operating mode	8001 hex	The control signals that determine the operation mode of the Reader/Writer could not be read. If this error is detected, the Reader/Writer will start in Safe Mode.
Invalid network setting	8002 hex	A mistake was detected in the network settings stored in memory in the Reader/Writer. If this error is detected, the Reader/Writer will start in Safe Mode.
Invalid RF communications setting	8003 hex	A mistake was detected in the RF communications settings stored in memory in the Reader/Writer.
Incorrect device setting data	8004 hex	A mistake was detected in the device settings stored in memory in the Reader/Writer.
Invalid system error log data	800F hex	A mistake was detected in the system error log stored in memory in the Reader/Writer. When this error occurs, only one record of it is left in the error log.
IP address conflict	8011 hex	The same IP address as the Reader/Writer was detected on the same network.
BOOTP server connection error	8012 hex	Communications with the BOOTP server could not be established to get the IP address.
Multi-Reader/Writer cannot start	8021 hex	Startup of Multi-Reader/Writer function failed.

Major Faults

Error name	Error code	Description
System configuration error	F00* hex	A mistake was detected in the system program or system data stored in memory in the Reader/Writer.
(Reserved)	---	
Non-volatile memory access error	F01* hex	Reading/writing non-volatile memory in the Reader/Writer failed.
(Reserved)	---	
Hardware fault	F02* hex	A failure was detected in the hardware in the Reader/Writer.
(Reserved)	---	

9-2-3 WDT Errors

A WDT timer occurs when a system runaway causes the watchdog timer to time out.

If a WDT error is detected when the system runs out of control during operation, the RUN indicator will go out and the NORM/ERR indicators will light red. There is no error code for a WDT error and no record is recorded in the system error log.

Error name	Error code	Description
WDT error	---	A system runaway in the Reader/Writer was detected. This is a fatal error, so you must either restart or replace the Reader/Writer.

Refer to 9-1-1 *Errors Indicated on Operation Indicators* on page 9-2 and 3-1-2 *Operation Indicators at Startup* on page 3-4 for information on the operation indicators when a WDT error occurs.

9-3 Errors and Countermeasures

This section gives the errors detected by the Reader/Writer and corresponding countermeasures. The items used in the following tables are described below.

Error name	The name of the error.	Error code	The value of the error code (four hexadecimal digits).
Description	A description of the error.		
Detection timing	When the error is detected.	Recovery method	How to recover from the error.
Log category	The type of log the error is recorded in.		
Additional information 1	A description of the additional information 1 that is recorded.	Additional information 2	A description of the additional information 2 that is recorded.
Probable cause	A description of the probable cause of the error.		
Workaround	A description of countermeasures for the probable cause of the error.		
Precautions/Remarks	Precautions, restrictions, and other supplemental information.		

9-3-1 Command Errors

Error name	Unknown command error	Error code	1003 hex
Description	A command that is not supported was received.		
Detection timing	At command reception	Recovery method	None
Log category	Command error log		
Additional information 1	None	Additional information 2	None
Probable cause	A command that is not supported by the Reader/Writer was received.		
Workaround	Check the command contents and send the command again.		
Precautions/Remarks	None		

Error name	Command parameter error	Error code	1005 hex
Description	There was an error in the parameters of the received command.		
Detection timing	At command reception	Recovery method	None
Log category	Command error log		
Additional information 1	None	Additional information 2	None
Probable cause	A parameter exceeding the setting range supported by the command is set.		
Workaround	Check the command contents and send the command again.		
Precautions/Remarks	None		

Error name	Command execution failure, busy	Error code	1011 hex
Description	The Reader/Writer was executing another command and could not execute the received command.		
Detection timing	At command execution	Recovery method	None
Log category	Command error log		
Additional information 1	None	Additional information 2	None
Probable cause	(1) An RF communications command was received during a setting change. (2) A setting command was received during execution of an RF communications command.		
Workaround	Check the operation status of the Reader/Writer and send the command again.		
Precautions/Remarks	None		

Error name	Command execution failure (inappropriate operation mode)	Error code	1012 hex
Description	The received command cannot be executed in the current operation mode of the Reader/Writer.		
Detection timing	At command execution	Recovery method	None
Log category	Command error log		
Additional information 1	None	Additional information 2	None
Probable cause	An RF communications command was received during operation in Safe Mode.		
Workaround	Check the operation mode of the Reader/Writer and send the command again.		
Precautions/Remarks	None		

Error name	Command execution failure (inappropriate RF communications mode)	Error code	1013 hex
Description	The received command cannot be executed in the current RF communications mode of the Reader/Writer.		
Detection timing	At command execution	Recovery method	None
Log category	Command error log		
Additional information 1	None	Additional information 2	None
Probable cause	A multiaccess RF communications command was received in Focus Mode.		
Workaround	Check the RF communications mode of the Reader/Writer and send the command again.		
Precautions/Remarks	None		

Error name	Command execution failure, minor fault	Error code	1018 hex
Description	There was a system error (minor fault) in the Reader/Writer and the Reader/Writer could not execute the received command.		
Detection timing	At command execution	Recovery method	Restart the Reader/Writer.
Log category	Command error log		
Additional information 1	Error code*	Additional information 2	None
Probable cause	Refer to the error information for a minor fault in additional information 1.		
Workaround			
Precautions/Remarks	None		

*1. This provides information on the current minor fault.

Error name	Command execution failure, major fault	Error code	101F hex
Description	There was a system error (major fault) in the Reader/Writer and the Reader/Writer could not execute the received command.		
Detection timing	At command execution	Recovery method	Restart the Reader/Writer.
Log category	Command error log		
Additional information 1	Error code*	Additional information 2	None
Probable cause	Refer to the error information for a major fault in additional information 1.		
Workaround			
Precautions/Remarks	None		

*1. This provides information on the current major fault.

9-3-2 RF Tag Communications Error

Error name	RF Tag missing error	Error code	2001 hex
Description	An RF Tag could not be detected in the communications range.		
Detection timing	At RF communications execution	Recovery method	None
Log category	Command error log		
Additional information 1	None	Additional information 2	None
Probable cause	<p>(1) There is no RF Tag in the communications range of the Reader/Writer.</p> <p>(2) The ambient environment is affecting operation (radio wave interference or surrounding metal).</p> <p>(3) Collision occurred for responses from more than one RF Tag.</p> <p>(4) There is no RF Tag that meets the filter conditions in the RF communications settings in the communications range of the Reader/Writer.</p> <p>(5) The response from the RF tag is weak because transmission power tuning is not appropriate.</p>		
Workaround	<p>Make sure there is an RF Tag in the communications range.</p> <p>Adjust the execution timing of the command to start communications with the RF Tag.</p> <p>Prepare an RF Tag that meets the filter conditions or revise the conditions.</p> <p>Increase or reduce transmission power tuning.</p>		
Precautions/Remarks			

Error name	RF Tag communications failed	Error code	2002 hex
Description	Communications with the RF Tag did not end normally.		
Detection timing	At RF communications execution	Recovery method	None
Log category	Command error log		
Additional information 1	Manufacturer analysis code 1	Additional information 2	Manufacturer analysis code 2
Probable cause	<p>(1) There is no RF Tag in the stable communications range of the RF Tag.</p> <p>(2) The ambient environment is affecting operation (radio wave interference or surrounding metal).</p> <p>(3) Collision occurred for responses from more than one RF Tag.</p> <p>(4) The response from the RF tag is weak because transmission power tuning is not appropriate.</p>		
Workaround	<p>Make sure there is an RF Tag in the stable communications range.</p> <p>Adjust the execution timing of the command to start communications with the RF Tag.</p> <p>Increase or reduce transmission power tuning.</p>		
Precautions/Remarks			

Error name	RF Tag address error	Error code	2004 hex
Description	The access address for the RF Tag is outside of the area supported by the target RF Tag.		
Detection timing	At RF communications execution	Recovery method	None
Log category	Command error log		
Additional information 1	None	Additional information 2	None
Probable cause	<p>(1) The start address to the RF Tag access area specified in the command exceeds the memory area of the RF Tag.</p> <p>(2) The size the RF Tag access area specified in the command exceeds the memory area of the RF Tag.</p>		
Workaround	Make sure that the RF Tag access area specified in the command matches the memory area in the RF Tag that is being used.		
Precautions/Remarks			

Error name	RF Tag lock error	Error code	2005 hex
Description	Access to an area that is locked in the RF Tag failed.		
Detection timing	At RF communications execution	Recovery method	None
Log category	Command error log		
Additional information 1	None	Additional information 2	None
Probable cause	<p>(1) The RF Tag is locked and the access password is not set in the Reader/Writer.</p> <p>(2) The RF Tag is locked and the access password does not match the access password set in the Reader/Writer.</p>		
Workaround	<p>Check the access password set in the RF Tag.</p> <p>Set the access password from the RF Tag in the Reader/Writer and execute the command again.</p>		
Precautions/Remarks			

Error name	RF Tag verification error	Error code	2006 hex
Description	Verification was performed for the results of writing data to the RF Tag, but inconsistencies were discovered.		
Detection timing	At RF communications execution	Recovery method	None
Log category	Command error log		
Additional information 1	None	Additional information 2	None
Probable cause	(1) There is no RF Tag in the stable communications range of the RF Tag. (2) The ambient environment is affecting operation (radio wave interference or surrounding metal). (3) Collision occurred for responses from more than one RF Tag.		
Workaround	Execute the command again. If the same error still occurs, try the following measures. Make sure there is an RF Tag in the stable communications range. Adjust the execution timing of the command to start communications with the RF Tag.		
Precautions/Remarks			

Error name	RF Tag system error	Error code	2008 hex
Description	The RF Tag returned an error response.		
Detection timing	At RF communications execution	Recovery method	None
Log category	Command error log		
Additional information 1	Manufacturer analysis code	Additional information 2	Manufacturer analysis code
Probable cause	(1) The RF Tag does not support the RF communications protocol of the Reader/Writer (ISO-18000-6C (Gen2)). (2) The RF Tag is faulty.		
Log category			
Workaround	Consult with your OMRON representative concerning RF Tags that can communicate with the Reader/Writer. Replace the RF Tags with RF Tags that can communicate with the Reader/Writer.		
Precautions/Remarks			

Error name	Password error	Error code	2009 hex
Description	The access password does not match the RF Tag.*		
Detection timing	At RF communications execution	Recovery method	None
Log category	Command error log		
Additional information 1	None	Additional information 2	None
Probable cause	The access code in the RF Tag and the access code set in the Reader/Writer do not agree.		
Workaround	Check the access password set in the RF Tag.		
Precautions/Remarks			

*1. When the environment is unstable, this error can occur even if the access password is correct.

Error name	Communications error between Reader/Writers	Error code	200B hex
Description	The master Reader/Writer will establish communications with the slave Reader/Writers during execution of the Multi-Reader/Writer function.		
Detection timing	At RF communications execution	Recovery method	None
Log category	Command error log		
Additional information 1	Reader/writer number (slave Reader/Writer)	Additional information 2	None
Probable cause	(1) Slave Reader/Writer does not operate normally. (2) Slave Reader/Writer is not correctly connected to the network.		
Workaround	(1) Check that the slave Reader/Writer does operates normally. (2) confirm that the master Reader/Writer unit is connected to a network capable of communications.		
Precautions/Remarks			

Error name	Communications canceled	Error code	2011 hex
Description	Processing was canceled when a STOP command was received before an RF Tag was detected.		
Detection timing	At RF communications execution	Recovery method	None
Log category	Command error log		
Additional information 1	None	Additional information 2	None
Probable cause	(1) Processing was canceled when an OFF EXE signal was received before an RF Tag was detected.		
Workaround	Check the reason the EXE signal was turned OFF in the host device.		
Precautions/Remarks	The contents of the RF Tag was not changed, even for a DATA WRITE command.		

Error name	Communications aborted	Error code	2012 hex
Description	Processing was aborted when a STOP command was received during communications with an RF Tag.		
Detection timing	At RF communications execution	Recovery method	None
Log category	Command error log		
Additional information 1	None	Additional information 2	None
Probable cause	(1) Processing was canceled when an OFF EXE signal was received during communications with an RF Tag.		
Workaround	Check the reason the EXE signal was turned OFF in the host device. The contents of the RF Tag may have been rewritten during processing. Check operation.		
Precautions/Remarks	The contents of the RF Tag was not changed, even for a DATA WRITE command.		

9-3-3 Minor Fault

Error name	Unfixed operating mode	Error code	8001 hex
Description	The control signals that determine the operation mode of the Reader/Writer could not be read.		
Detection timing	At startup	Recovery method	Reboot.
Log category	System error log		
Additional information 1	None	Additional information 2	None
Probable cause	(1) The connections of the control signals on the power supply connector to the Reader/Writer are not stable. (2) Operation is being affected by ambient noise.		
Workaround	(1) Check the connection of the control signal line to the 24 VDC terminal on the power supply. (2) Check for sources of noise around the power supply cable.		
Precautions/Remarks	If this error is detected, the Reader/Writer will start in Safe Mode.		

Error name	Invalid network setting	Error code	8002 hex
Description	A mistake was detected in the network settings stored in memory in the Reader/Writer.		
Detection timing	At startup	Recovery method	Reboot.
Log category	System error log		
Additional information 1	None	Additional information 2	None
Probable cause	(1) There is data corruption in the memory of the Reader/Writer. (2) The memory in the Reader/Writer has reached its service life or is faulty.		
Workaround	Initialize the network settings. (Use the INITIALIZE command or initialize the settings from the Web Browser Interface.)		
Precautions/Remarks	If this error is detected, the Reader/Writer will start in Safe Mode.		

Error name	Invalid RF communications setting	Error code	8003 hex
Description	A mistake was detected in the RF communications settings stored in memory in the Reader/Writer.		
Detection timing	At startup	Recovery method	Reboot.
Log category	System error log		
Additional information 1	0001 hex: Basic settings 0002 hex: Advanced settings	Additional information 2	None
Probable cause	(1) There is data corruption in the memory of the Reader/Writer. (2) Memory in the Reader/Writer has reached its service life or is faulty.		
Workaround	Initialize the RF communications settings. (Use the INITIALIZE command or initialize the settings from the Web Browser Interface.)		
Precautions/Remarks			

Error name	Incorrect device setting data	Error code	8004 hex
Description	A mistake was detected in the device settings stored in memory in the Reader/Writer.		
Detection timing	At startup	Recovery method	Reboot.
Log category	System error log		
Additional information 1	0001 hex: LED custom settings 0002 hex: Multi-Reader/Writer setting	Additional information 2	None
Probable cause	(1) There is data corruption in the memory of the Reader/Writer. (2) Memory in the Reader/Writer has reached its service life or is faulty.		
Workaround	Initialize the device settings. (Use the INITIALIZE command or initialize the settings from the Web Browser Interface.)		
Precautions/Remarks			

Error name	Invalid system error log data	Error code	800F hex
Description	A mistake was detected in the system error log stored in memory in the Reader/Writer.		
Detection timing	At startup	Recovery method	Reboot.
Log category	System error log		
Additional information 1	None	Additional information 2	None
Probable cause	(1) There is data corruption in the memory of the Reader/Writer. (2) Memory in the Reader/Writer has reached its service life or is faulty.		
Workaround	Delete the system error log. (Use the command to delete the system error log or delete it from the Web Browser Interface.)		
Precautions/Remarks	When this error occurs, only one record of it is left in the error log.		

Error name	IP address duplication error	Error code	8011 hex
Description	The same IP address as the Reader/Writer was detected on the same network.		
Detection timing	At startup	Recovery method	Reboot.
Log category	System error log		
Additional information 1	None	Additional information 2	None
Probable cause	There is another device on the same network as the Reader/Writer that has the same IP address.		
Workaround	Remove the Reader/Writer from the network, correct the IP addresses, and add the Reader/Writer to the network.		
Precautions/Remarks	Communications with the host device are not possible when this error occurs. Use the NORM/ERR indicators on the Reader/Writer to confirm this error. (The NORM/ERR indicators will flash irregularly twice.)		

Error name	BOOTP server connection error	Error code	8012 hex
Description	Communications with the BOOTP server could not be established to get the IP address.		
Detection timing	At startup	Recovery method	Reboot.
Log category	System error log		
Additional information 1	None	Additional information 2	None
Probable cause	(1) There is no BOOTP server on the same network as the Reader/Writer. (2) There are no settings for the Reader/Writer (MAC address and IP address) in the BOOTP server.		
Workaround	(1) Place a BOOTP server on the same network as the Reader/Writer. (2) Set the MAC address and IP address of the Reader/Writer in the BOOTP server.		
Precautions/Remarks	Communications with the host device is not possible when this error occurs. Use the NORM/ERR indicators on the Reader/Writer to confirm this error. (The NORM/ERR indicators will flash irregularly twice.)		

Error name	Multi-Reader/Writer cannot start	Error code	8021 hex
Description	Startup of Multi-Reader/Writer function failed.		
Detection timing	At startup	Recovery method	Reboot.
Log category	System error log		
Additional information 1	Cause code	Additional information 2	None
Probable cause	(1) [Cause code 00000001 hex: Incorrect mode] The Multi-Reader/Writer mode and communications mode combination is incorrect. (2) [Cause code 00000002 hex: IP address duplication] The IP address of the master Reader/Writer and a slave reader/writer are duplicated. (3) [Cause code 00000003 hex: Model mismatch] Communications are impossible due to a model mismatch of the master Reader/Writer and slave reader/writer. (4) [Cause code 00000004 hex: Version mismatch] Communications are impossible due to a version mismatch of the master Reader/Writer and slave reader/writer.		
Workaround	(1) Review the combination of the Multi-Reader/Writer mode and communications mode settings. (2) Review the IP address settings of the master Reader/Writer and a slave Reader/Writers. (3) Replace with a slave Reader/Writer matching the model of the master reader/writer. (4) Replace with a slave Reader/Writer matching the version of the master reader/writer.		
Precautions/Remarks			

9-3-4 Major Fault

Error name	System configuration error	Error code	F00* hex
Description	A mistake was detected in the system program or system data stored in memory in the Reader/Writer.		
Detection timing	At startup	Recovery method	Reboot.
Log category	System error log		
Additional information 1	None	Additional information 2	None
Probable cause	Memory inside the Reader/Writer is faulty.		
Workaround	If this error continues to occur even if you restart the Reader/Writer, replace the Reader/Writer.		
Precautions/Remarks	If this error is detected, the Reader/Writer will start in Safe Mode.		

Error name	Non-volatile memory access error	Error code	F01* hex
Description	Reading/writing non-volatile memory in the Reader/Writer failed.		
Detection timing	At change to settings	Recovery method	Reboot.
Log category	System error log		
Additional information 1	None	Additional information 2	None
Probable cause	Memory inside the Reader/Writer is faulty.		
Workaround	If this occurs continues to occur even if you restart the Reader/Writer, replace the Reader/Writer.		
Precautions/Remarks			

Error name	Hardware fault	Error code	F02* hex
Description	A failure was detected in the hardware in the Reader/Writer.		
Detection timing	At RF communications execution	Recovery method	Reboot.
Log category	System error log		
Additional information 1	None	Additional information 2	None
Probable cause	The IC or antenna in the Reader/Writer is faulty.		
Workaround	If this occurs continues to occur even if you restart the Reader/Writer, replace the Reader/Writer.		
Precautions/Remarks			

9-3-5 WDT Error

Error name	WDT error	Error code	None
Description	A watchdog timer timeout that resulted from CPU runaway in the Reader/Writer was detected.		
Detection timing	During operation	Recovery method	Reboot.
Log category	None		
Probable cause	A hardware failure or temporary data corruption caused the CPU runaway.		
Workaround	If this occurs continues to occur even if you restart the Reader/Writer, replace the Reader/Writer.		
Precautions/Remarks	A WDT error is not recorded in the command error log or system error log.		

9-4 Cannot Display the Web Browser Operation Window

This section describes countermeasures when you cannot access the Reader/Writer Web browser interface (i.e., when you cannot display the operation window).

Only countermeasures that have been confirmed by OMRON are provided. They may not solve all possible problems. Contact your OMRON representative if you have problems that cannot be solved.

9-4-1 Problem

When the Web browser Reader/Writer interface is used to display the Web operation window, the OMRON logo is displayed and an error message is displayed instead of the operation menu.

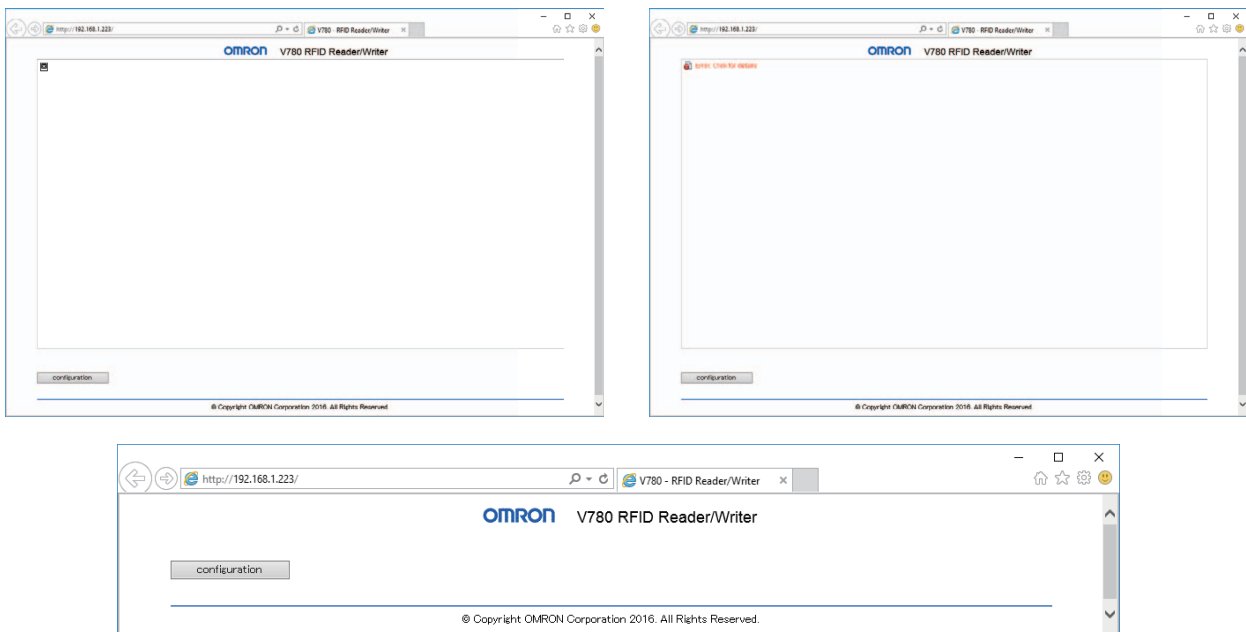

9-4-2 Solution

Check the message that appears when you try to start the Web browser interface, and then perform the corresponding procedure.

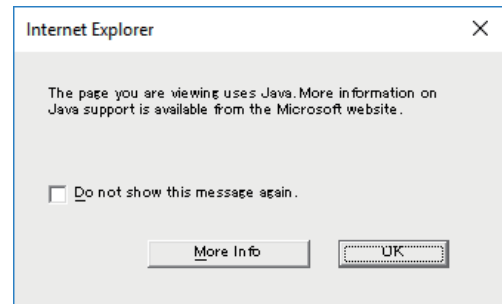
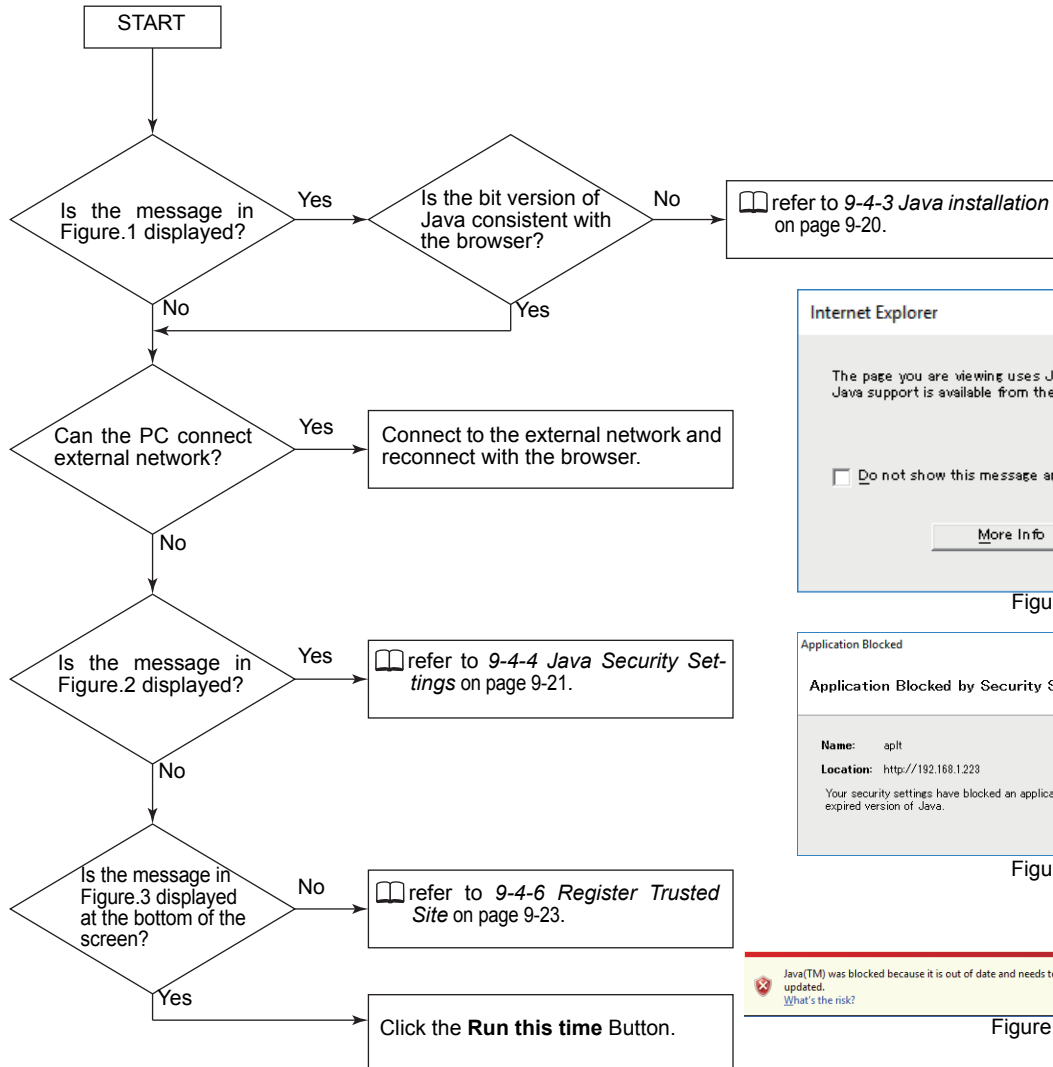

Figure.1

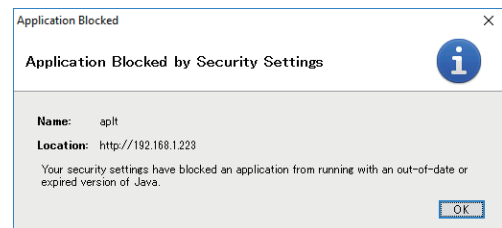

Figure.2

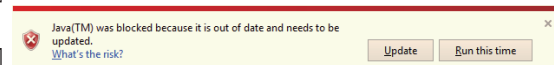
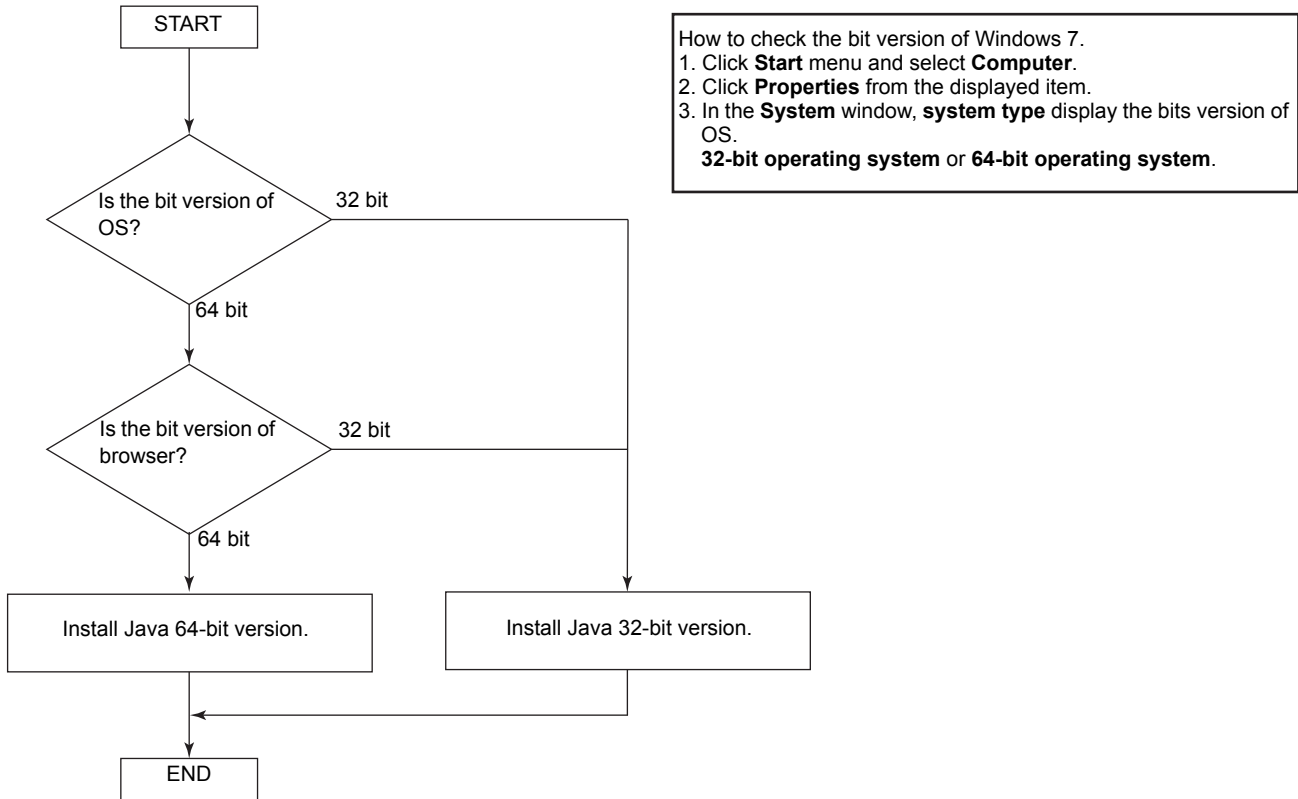

Figure.3

9-4-3 Java installation

Install Java bit version (64-bit or /32-bit) decided by the following flow.



9-4-4 Java Security Settings

(1) Open the Control Panel and click the **Java** Icon.

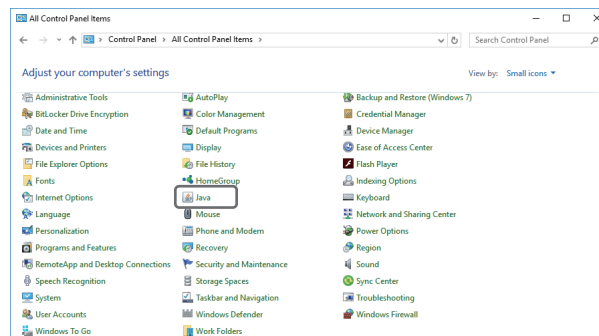

(2) Click the **Security** Tab and change the security level from **High** to **Medium**.

* If the security settings are not displayed, refer to *Java Security Settings Are Not Displayed* on page 9-22.

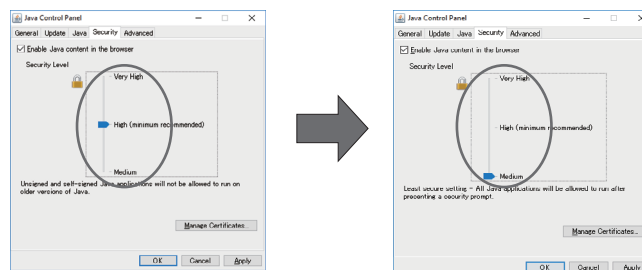

Precautions for Correct Use

This procedure will reduce the security verification performed for execution of Java applications and therefore it may affect the execution of other Java applications.

(3) Restart the web browser and access the IP address of the Reader/Writer again.

The following warning message displayed at the first time. Click the **Run** button.

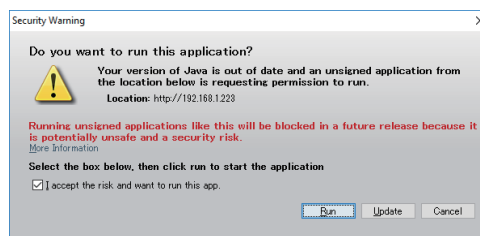

9-4-5 Java Security Settings Are Not Displayed

This section describes the countermeasure when the exception site list is not displayed and operation is not possible.

If the tab page to change Java security settings does not appear and you cannot change the settings when you select the Security Tab in step 2 of the procedure in Countermeasure for Security Settings, use the following procedure.

- (1) Open the Control Panel and uninstall all Java programs.
- (2) After you uninstall all of the programs, go to the following website and install Java.

<https://www.oracle.com/technetwork/java/archive-139210.html>

(*URL is as of April 2019 and may change in the future.)



Precautions for Correct Use

Refer to *8-1 Browser Operation Interface* on page 8-2 for Java versions that can be used.



Precautions for Correct Use

Java security features have been improved for the most recent version of Java, so the same problem may occur.

9-4-6 Register Trusted Site

- (1) Open the Web browser, click the **Tools** menu and select **Internet Options**.
- (2) Click the **Security** tab, select **Trusted sites** and click **Sites** button.

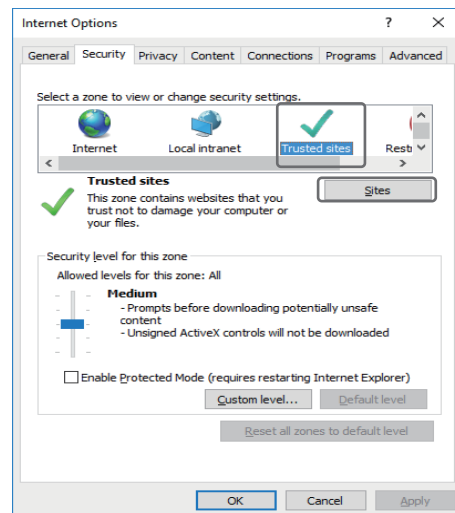

- (3) In the **Add this Web site to the zone** box, enter the IP address of the target Reader/Writer, and then click Add.

http: // "IP address of target device"

ex) http://192.168.1.200/

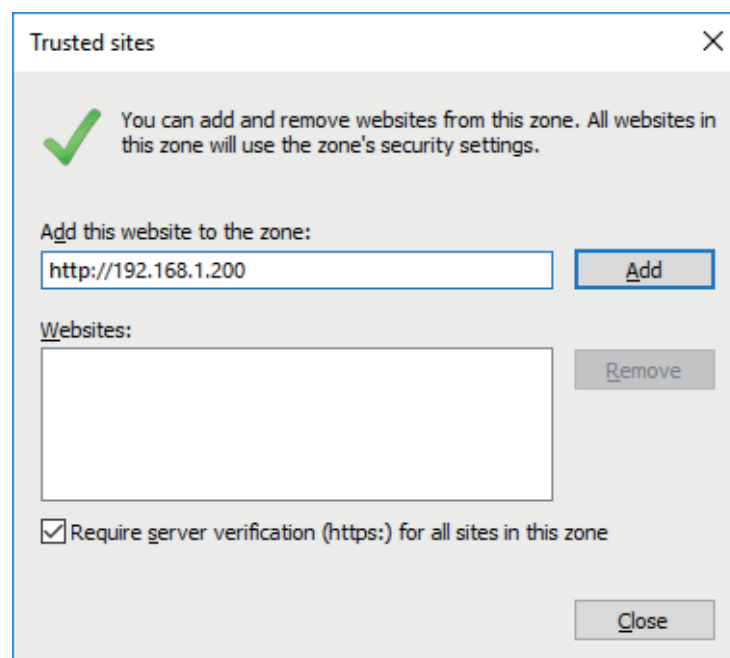

9-4-7 Countermeasures for Other Problems

(1) Open the Control Panel and click the **Java** icon.

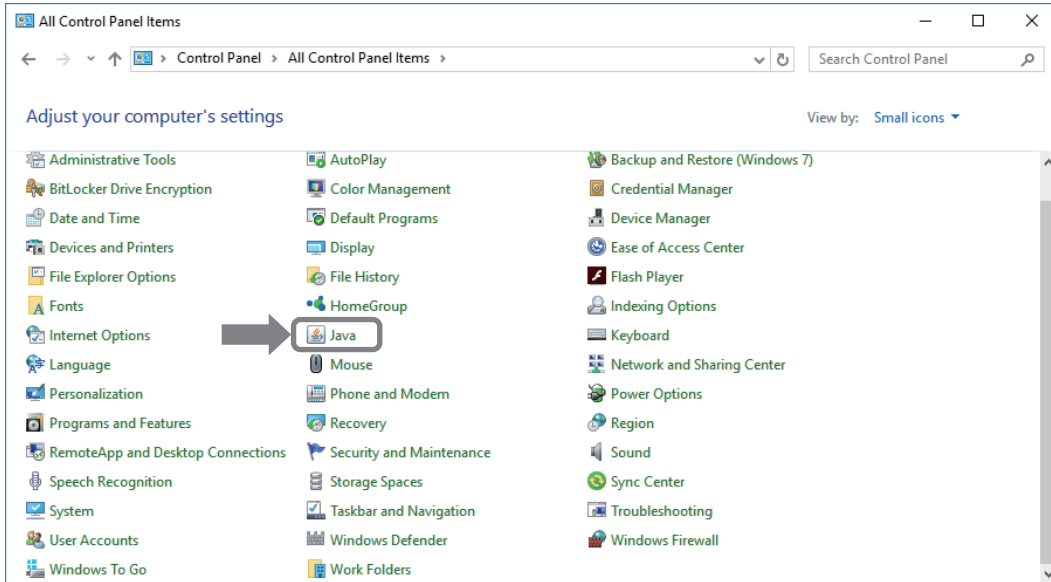

(2) Click the **Settings** Button in the **Temporary Internet Files** Area on the **General** Tab Page.

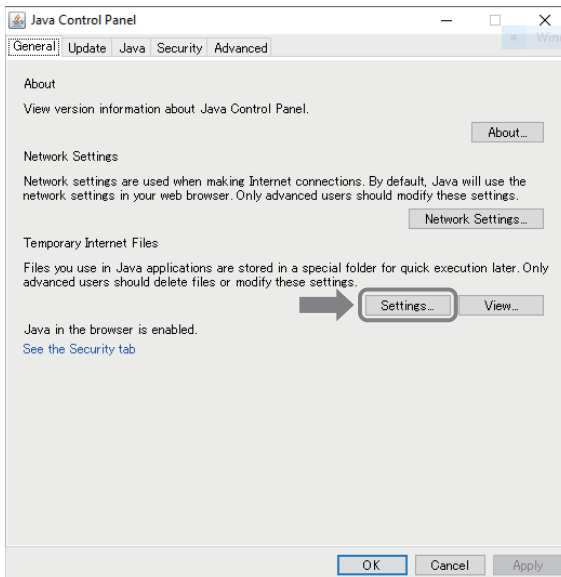

(3) Select the **Keep temporary files on my computer** Check Box and click the **Delete Files** Button.

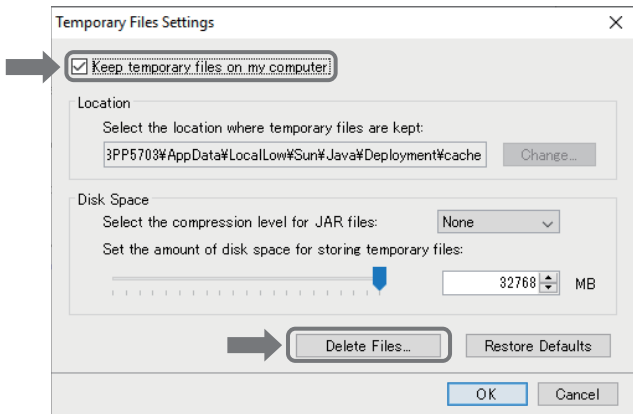

(4) Click the **OK** Button.

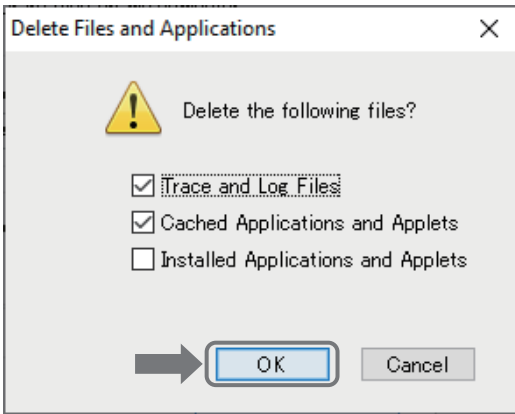

(5) When the files have been deleted, click the **OK** Button and close all windows. Then, restart the Web browser and connect to the Amplifier Unit again.

10

Maintenance and Inspection

This section describes maintenance and inspections for a V780 Reader/Writer.

10-1 Maintenance and Inspection	10-2
--	-------------

10-1 Maintenance and Inspection

The Reader/Writer must be inspected on a daily or periodic basis so that the functions remain in good condition.

The Reader/Writer consists of semiconductors that last almost indefinitely. The following malfunctions, however, may result due to the operating environment and conditions.

- (1) Element deterioration due to overvoltage or overcurrent.
- (2) Element deterioration due to continuous stress caused by high ambient temperature.
- (3) Connector contact faults or insulation deterioration due to humidity and dust.
- (4) Connector contact faults or element corrosion due to corrosive gas.

Inspection Items

No.	Inspection item	Details	Criteria	Remarks
1	Supply voltage fluctuation	(1) Check that the supply voltage fluctuation at the power supply terminal block is within the permissible range.	Within supply voltage specified range	Multimeter
		(2) Check that there are no frequent instantaneous power failures or radical voltage fluctuations.	Within permissible voltage fluctuation range	Power supply analyzer
2	Ambient environment			Maximum and minimum thermometer Hygrometer
	(A) Temperature	(A) Within the specified range	(A) -10 to 55°C	
	(B) Humidity	(B) Within the specified range	(B) 25% to 85%	
	(C) Vibration and shock	(C) Influence of vibration or shock from machines	(C) Within the specified range	
	(D) Dust	(D) Make sure that the Reader/Writer is free of accumulated dust and foreign particles.	(D) Must not be present.	
(E) Corrosive gas	(E) Check that no metal part of the system is discolored or corroded.	(E) Must not be present.		

No.	Inspection item	Details	Criteria	Remarks
3	Panel condition (A) Ventilation	(A) Check that the system is ventilated properly with natural ventilation, forced ventilation, or cooling air.	(A) The interior temperature must be within a range between -10 and 55°C with proper ventilation.	---
	(B) Damage to packing for any enclosing structure	(B) Make sure that the panel packing is properly attached with no damage.	(B) The packing must have no damage.	
4	Mounting condition	(1) Make sure that the Reader/Writer is securely mounted.	No loose screws	---
		(2) Make sure that each connector is fully inserted.	Each connector must be locked or securely tightened with screws.	---
		(3) Make sure that no wire is broken or nearly broken.	Must be no wire that is broken or nearly broken.	---



Appendices

The appendices provide various specifications related to communications with RF Tags and other supplemental information.

A-1 Licensing Procedures of Premises Radio Station	A-2
A-2 RF Tag Communications Times (for Reference Only)	A-4
A-3 RF Tag Memory Map	A-17
A-4 Communications Range Diagram, Reception Level Diagram (Reference Only)	A-18
A-5 Mutual Interference of Reader/Writers (Reference Only)	A-25
A-6 Chemical Resistance of the Reader/Writers	A-29

A-1 Licensing Procedures of Premises Radio Station

V780-HMD68-EIP-JP/V780-HMD68-ETN-JP-S is a wireless facility of premises radio station to differentiate moving object using the 920-MHz band. The licensing procedures of the premises radio station must be performed before use. Be sure to perform the licensing procedures before use.

Introduction

As for the licensing procedures of the premises radio station, check the information regarding the latest procedures, and the documents necessary for the procedures on the Website of the Regional Bureau of Telecommunications.

The licensing procedures involve the submission of an application for a license at the local Regional Bureau of Telecommunications. A Regional Bureau of Telecommunications falls under the jurisdiction of each district. Please confirm your Regional Bureau of Telecommunications to perform the procedures.

For details on the Regional Bureau of Telecommunications in each district where you can perform the licensing procedures, refer to the Radio Use Website of the Ministry of Internal Affairs and Communications (<http://www.tele.soumu.go.jp/e/ref/material/commtab1/index.htm>).

Example) For the Kanto area (Ibaraki, Tochigi, Gunma, Saitama, Chiba, Tokyo, Kanagawa and Yamanashi)
 Contact the Kanto Bureau of Telecommunications (Website URL: <http://www.soumu.go.jp/soutsu/kanto/>).

For details on the licensing procedures system, refer to the Radio Use Website of the Ministry of Internal Affairs and Communications (<http://www.tele.soumu.go.jp/e/adm/proc/type/index.htm>).

The URL described above is effective as of July 2019.

Flow of Licensing Procedures (Overview)

The licensing procedures involve the submission of an application for a license in order to set up a radio station. When an application for a license is submitted, a license is issued. Once the license is received, the procedures are complete.

The flow of the licensing procedures is shown below.

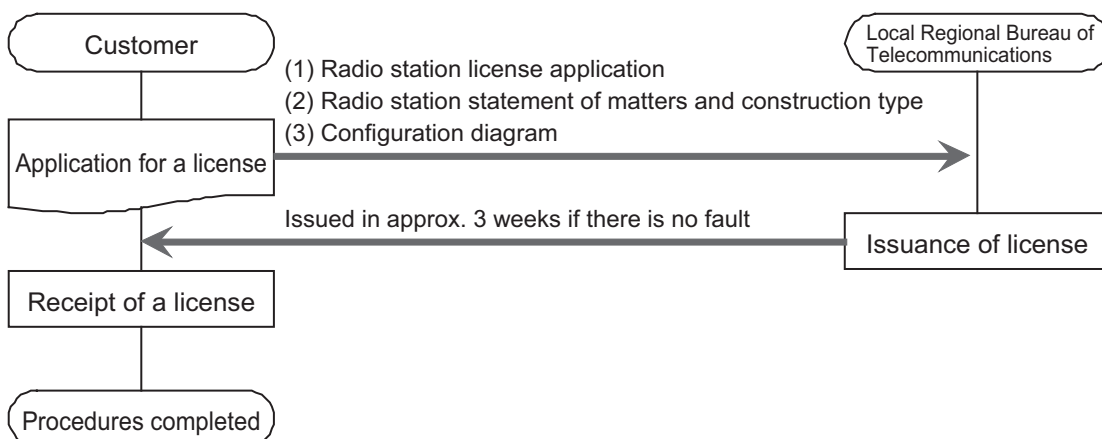

- * Please enclose a self-addressed return envelope for receipt of your license when applying for a license.
- * The license is effective for a period of 5 years (you will have to apply again for a license after 5 years.)
- * In case of any changes in the license contents or establishment report contents, you will have to perform change procedures.
- * If the license is no longer in use, please submit a discard report.
- * If there are any changes in the contact address, or the address for sending the radio use charges payment notice, or any changes in the station location, you will have to perform change procedures. You are requested to do the needful.

A-2 RF Tag Communications Times (for Reference Only)

The RF communications time is the time from when the host device sends a communications command to the Reader/Writer until it receives a response. The communications time differs depending on the radio regulations of each country, or the settings of the RF communications command and RF communications speed. In actual usage, the communications time may change under the influence of the installation environment, system conditions, type of RF Tags, and other factors. Perform sufficient testing in advance.



Precautions for Correct Use

If you enable communications diagnostics, the communications times will be increased by up to 100 ms.

Measurement Conditions

Measurement environment	Radio wave darkroom	
RF Tag	V780-A-JIME-Z3BLI-10 (made by Toppan Forms Co., Ltd.)* ¹	
Communications distance	Fixed at 0.5 m (between Reader/Writer and RF Tag)	
Transmission power	27 dBm	
RF communications speed	Given below.	
Communications command	Given below.	
Communications distance	Fixed at 0.5 m (between Reader/Writer and RF Tag)	Fixed at 1.8 m (between Reader/Writer and RF Tag)
		1 to 64 sheets

*1. The RF Tag was mounted to a V780-A-TA-133-10 Attachment.



Precautions for Correct Use

With multiaccess communications, collisions occur between communications with multiple RF Tags. Therefore, the communications time varies more than with single-access communications. The communications time also varies with the RF Tags that are used, the orientation of the RF Tags, and the ambient environment. Therefore, the communications times in the above graphs are strictly for reference only. Use them only as reference values for determining communications timeout times in the actual environment.

V780-HMD68-EIP-JP/V780-HMD68-ETN-JP-S

● ID READ (Single-access)

During 6-word (96bit) data readout from the UII (EPC) area

RF communications speed	Communications time
High speed	15 ms
Normal speed	27 ms

Single-access		
	RF communications speed	Communications time (ms) N : No. of bytes processed
DATA READ	High speed	$T=0.23N+18.6$
	Normal speed	$T=0.89N+32.3$
DATA WRITE (with verification)	High speed	$T=11.2N+17.0$
	Normal speed	$T=16.4N+31.3$
DATA WRITE (without verification)	High speed	$T=11.0N+12.2$
	Normal speed	$T=15.5N+24.2$

Single-access		
	RF communications speed	Communications time (ms) N : No. of Tags
Multi-ID READ	High speed	$T=19.6N+21.6$
	Normal speed	$T=32.8N+25.8$
Multi-DATA READ	High speed	$T=29.8N+22.2$
	Normal speed	$T=66.4N+33.9$

● DATA READ (Single-access)

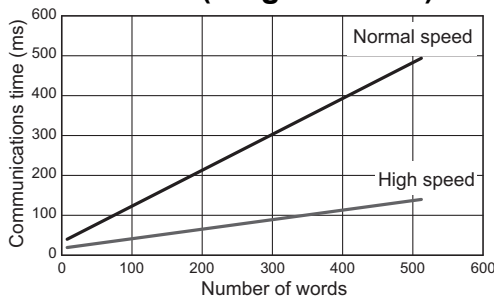

● DATA WRITE (Single-access)

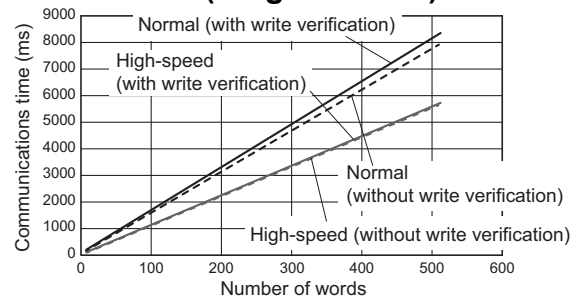

● ID READ (Multi-access)

During 6-word (96bit) data readout from the UII (EPC) area

• Firmware Ver 3.01 or later

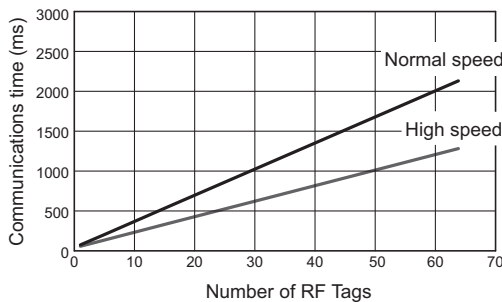

• Firmware Ver 3.00 or earlier

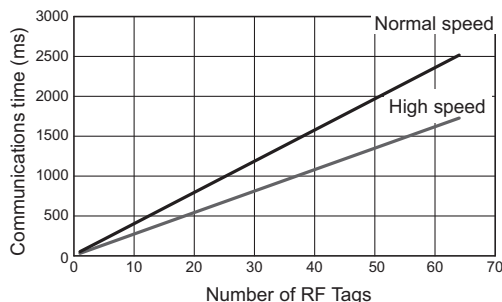

● DATA READ (Multi-access)

Reading 32 Words of Data from the User Area

• Firmware Ver 3.01 or later

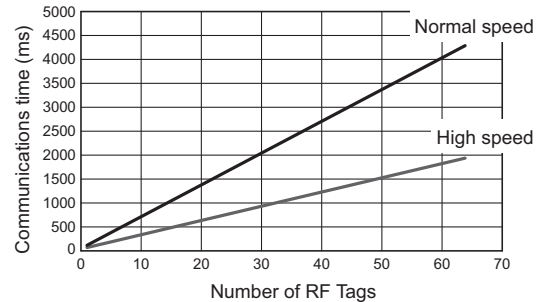

• Firmware Ver 3.00 or earlier

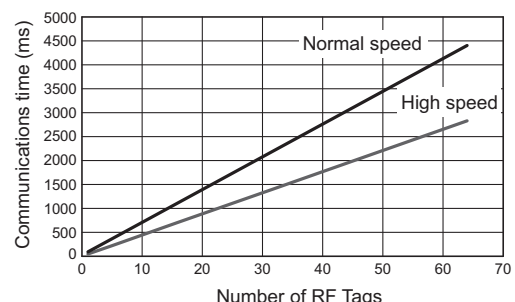

V780-HMD68-EIP-KR/V780-HMD68-ETN-KR-S

● ID READ (Single-access)

During 6-word (96bit) data readout from the UII (EPC) area

RF communications speed	Communications time
High speed	21 ms
Normal speed	27 ms

Single-access

	RF communications speed	Communications time (ms) N : No. of bytes processed
DATA READ	High speed	$T=0.33N+23.8$
	Normal speed	$T=0.68N+30.4$
DATA WRITE (with verification)	High speed	$T=12.3N+13.2$
	Normal speed	$T=15.1N+20.1$
DATA WRITE (without verification)	High speed	$T=11.9N+11.8$
	Normal speed	$T=14.4N+17.1$

Single-access

	RF communications speed	Communications time (ms) N : No. of Tags
Multi-ID READ	High speed	$T=20.3N+25.1$
	Normal speed	$T=27.7N+33.5$
Multi-DATA READ	High speed	$T=33.2N+22.0$
	Normal speed	$T=52.8N+33.6$

● DATA READ (Single-access)

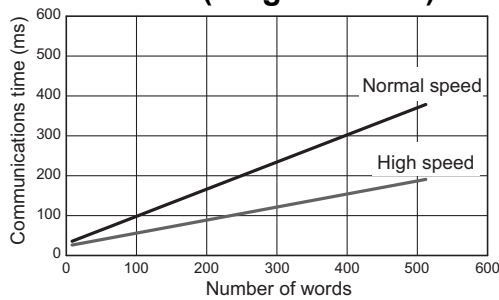

● DATA WRITE (Single-access)

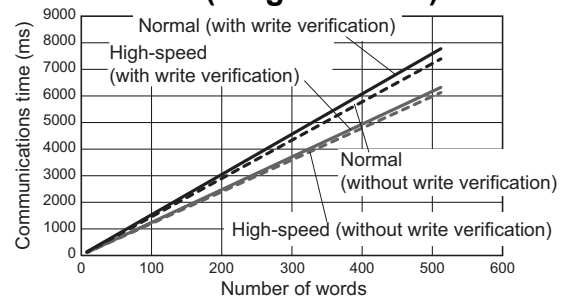

● ID READ (Multi-access)

During 6-word (96bit) data readout from the UII (EPC) area

• Firmware Ver 3.01 or later

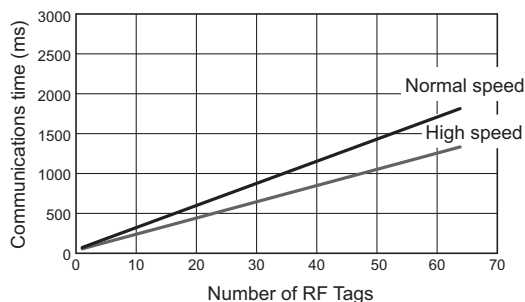

● DATA READ (Multi-access)

Reading 32 Words of Data from the User Area

• Firmware Ver 3.01 or later

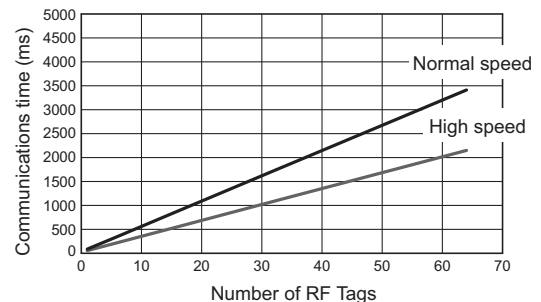

• Firmware Ver 3.00 or earlier

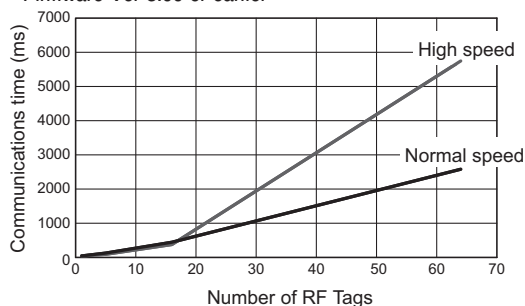

Firmware Ver 3.00 or earlier

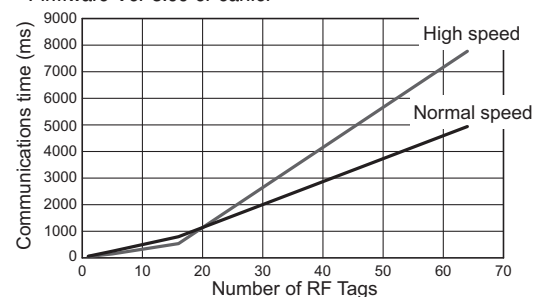

V780-HMD68-EIP-CN/V780-HMD68-ETN-CN-S

● ID READ (Single-access)

During 6-word (96bit) data readout from the UII (EPC) area

RF communications speed	Communications time
High speed	17 ms
Normal speed	29 ms

Single-access

	RF communications speed	Communications time (ms) N : No. of bytes processed
DATA READ	High speed	$T=0.33N+19.2$
	Normal speed	$T=1.04N+32.9$
DATA WRITE (with verification)	High speed	$T=11.5N+15.3$
	Normal speed	$T=16.9N+28.8$
DATA WRITE (without verification)	High speed	$T=11.2N+13.1$
	Normal speed	$T=15.8N+25.3$

Single-access

	RF communications speed	Communications time (ms) N : No. of Tags
Multi-ID READ	High speed	$T=21.3N+18.5$
	Normal speed	$T=34.7N+24.3$
Multi-DATA READ	High speed	$T=29.9N+20.2$
	Normal speed	$T=69.1N+26.7$

● DATA READ (Single-access)

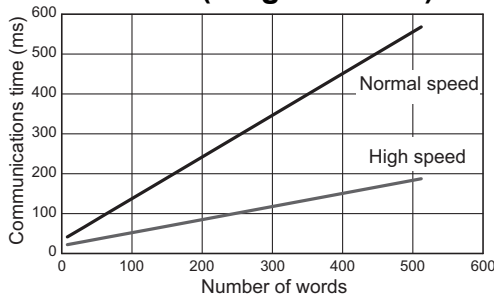

● DATA WRITE (Single-access)

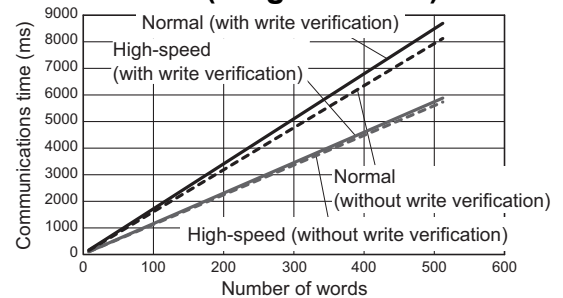

● ID READ (Multi-access)

During 6-word (96bit) data readout from the UII (EPC) area

• Firmware Ver 3.01 or later

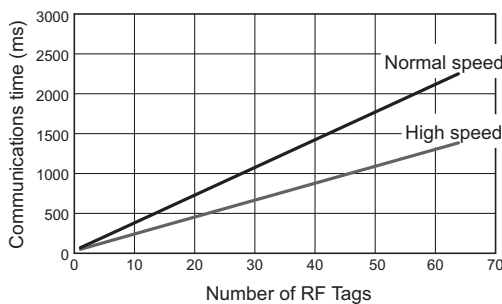

• Firmware Ver 3.00 or earlier

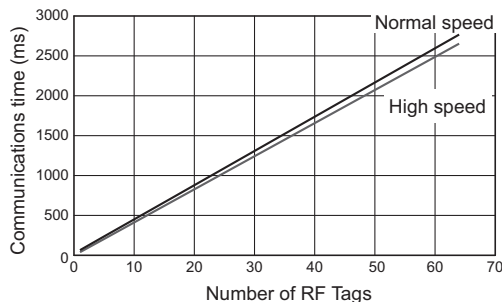

● DATA READ (Multi-access)

Reading 32 Words of Data from the User Area

• Firmware Ver 3.01 or later

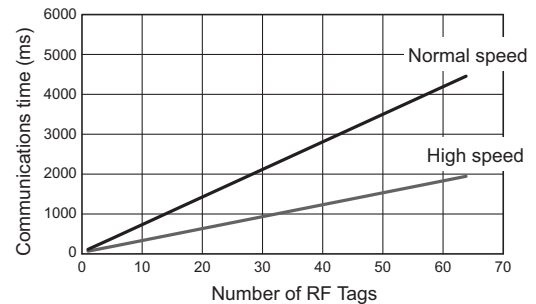

• Firmware Ver 3.00 or earlier

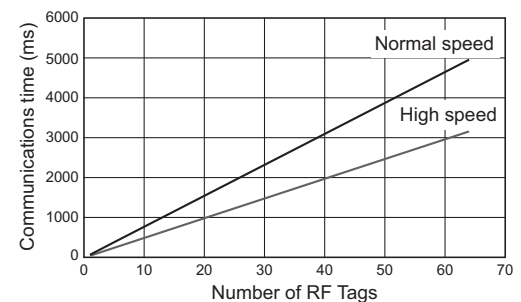

V780-HMD68-EIP-TW/V780-HMD68-ETN-TW-S

● ID READ (Single-access)

During 6-word (96bit) data readout from the UII (EPC) area

RF communications speed	Communications time
High speed	21 ms
Normal speed	27 ms

Single-access

	RF communications speed	Communications time (ms) N : No. of bytes processed
DATA READ	High speed	$T=0.33N+23.8$
	Normal speed	$T=0.68N+30.4$
DATA WRITE (with verification)	High speed	$T=12.3N+13.2$
	Normal speed	$T=15.1N+20.1$
DATA WRITE (without verification)	High speed	$T=11.9N+11.8$
	Normal speed	$T=14.4N+17.1$

Single-access

	RF communications speed	Communications time (ms) N : No. of Tags
Multi-ID READ	High speed	$T=20.3N+25.1$
	Normal speed	$T=27.7N+33.5$
Multi-DATA READ	High speed	$T=33.2N+22.0$
	Normal speed	$T=52.8N+33.6$

● DATA READ (Single-access)

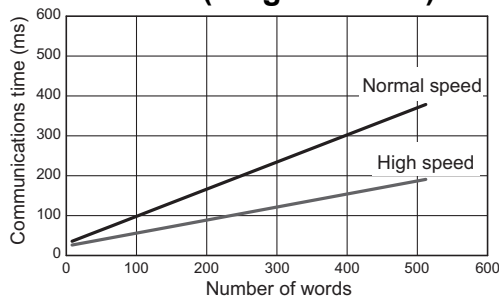

● DATA WRITE (Single-access)

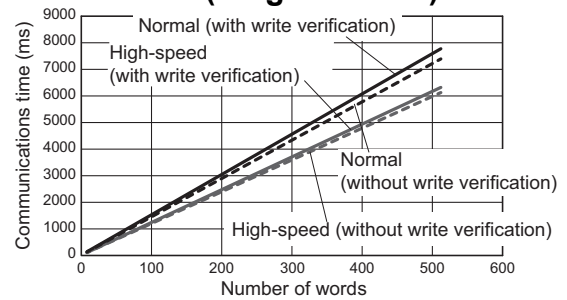

● ID READ (Multi-access)

During 6-word (96bit) data readout from the UII (EPC) area

• Firmware Ver 3.01 or later

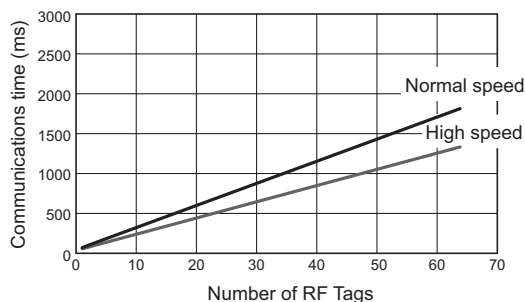

● DATA READ (Multi-access)

Reading 32 Words of Data from the User Area

• Firmware Ver 3.01 or later

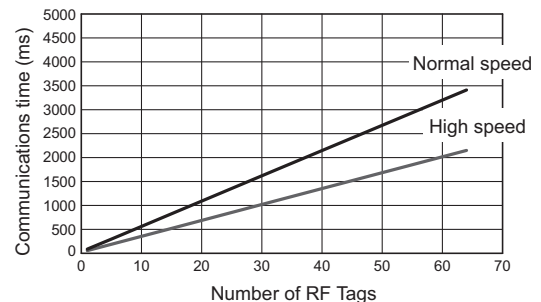

• Firmware Ver 3.00 or earlier

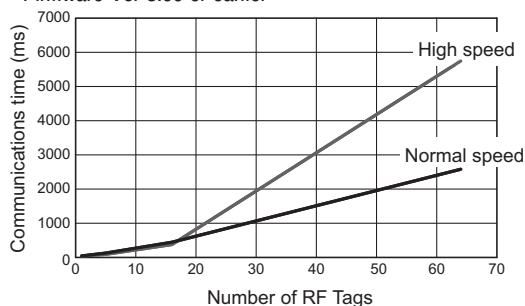

Firmware Ver 3.00 or earlier

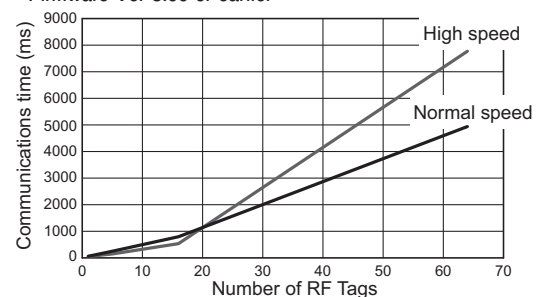

V780-HMD68-EIP-IN/V780-HMD68-ETN-IN-S

● ID READ (Single-access)

During 6-word (96bit) data readout from the Ull (EPC) area

RF communications speed	Communications time
High speed	21 ms
Normal speed	27 ms

Single-access		
	RF communications speed	Communications time (ms) N : No. of bytes processed
DATA READ	High speed	$T=0.33N+188$
	Normal speed	$T=0.69N+25.0$
DATA WRITE (with verification)	High speed	$T=11.6N+29.7$
	Normal speed	$T=14.8N+31.8$
DATA WRITE (without verification)	High speed	$T=11.2N+27.2$
	Normal speed	$T=14.0N+28.9$

Single-access		
	RF communications speed	Communications time (ms) N : No. of Tags
Multi-ID READ	High speed	$T=20.4N+23.5$
	Normal speed	$T=24.4N+25.2$
Multi-DATA READ	High speed	$T=30.1N+19.2$
	Normal speed	$T=45.2N+34.7$

● DATA READ (Single-access)

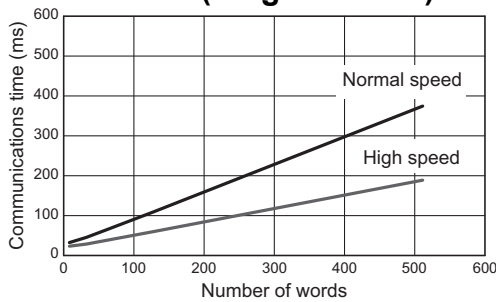

● DATA WRITE (Single-access)

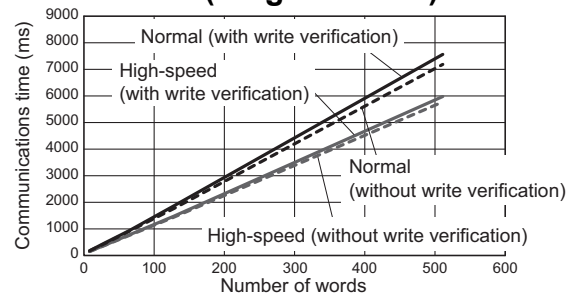

● ID READ (Multi-access)

During 6-word (96bit) data readout from the Ull (EPC) area

• Firmware Ver 3.01 or later

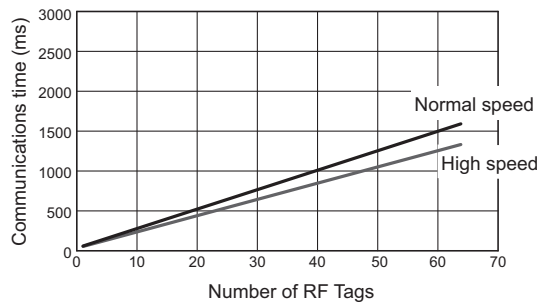

• Firmware Ver 3.00 or earlier

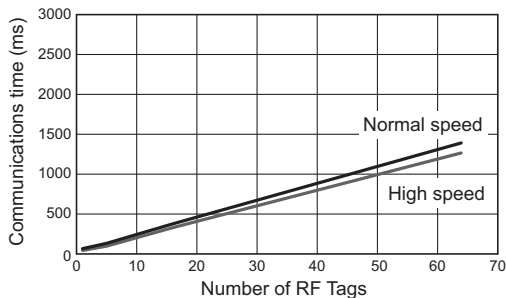

● DATA READ (Multi-access)

Reading 32 Words of Data from the User Area

• Firmware Ver 3.01 or later

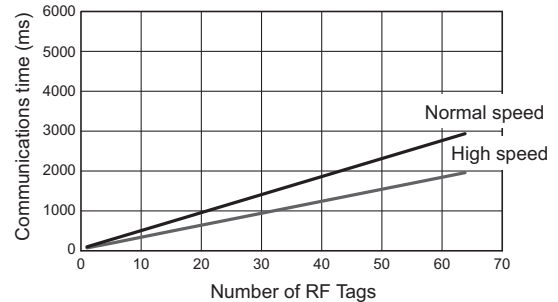

Firmware Ver 3.00 or earlier

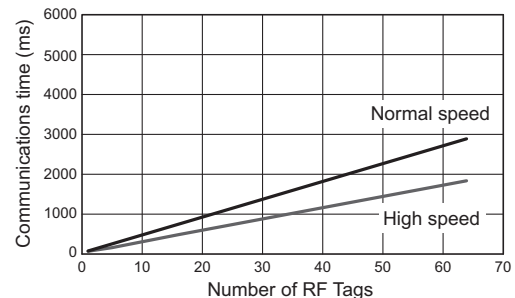

V780-HMD68-EIP-ID/V780-HMD68-ETN-ID-S

● ID READ (Single-access)

During 6-word (96bit) data readout from the UII (EPC) area

RF communications speed	Communications time
High speed	21 ms
Normal speed	27 ms

Single-access

	RF communications speed	Communications time (ms) N : No. of bytes processed
DATA READ	High speed	$T=0.33N+23.8$
	Normal speed	$T=0.68N+30.4$
DATA WRITE (with verification)	High speed	$T=12.3N+13.2$
	Normal speed	$T=15.1N+20.1$
DATA WRITE (without verification)	High speed	$T=11.9N+11.8$
	Normal speed	$T=14.4N+17.1$

Single-access

	RF communications speed	Communications time (ms) N : No. of Tags
Multi-ID READ	High speed	$T=20.3N+25.1$
	Normal speed	$T=27.7N+33.5$
Multi-DATA READ	High speed	$T=33.2N+22.0$
	Normal speed	$T=52.8N+33.6$

● DATA READ (Single-access)

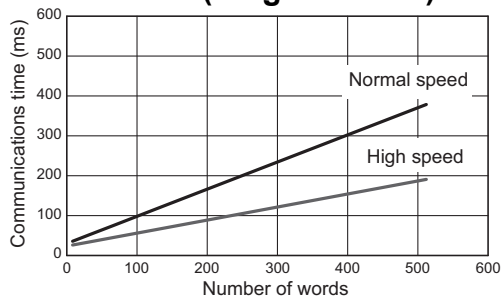

● DATA WRITE (Single-access)

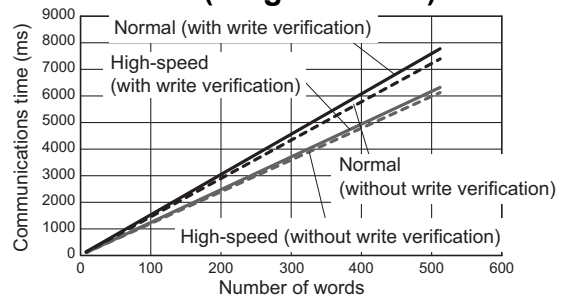

● ID READ (Multi-access)

During 6-word (96bit) data readout from the UII (EPC) area

• Firmware Ver 3.01 or later

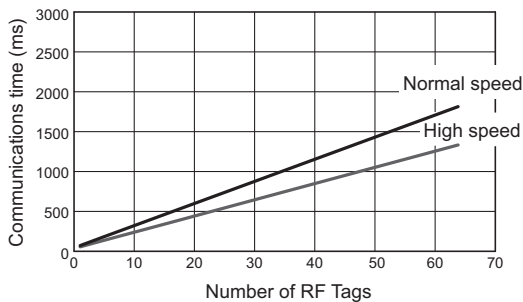

• Firmware Ver 3.00 or earlier

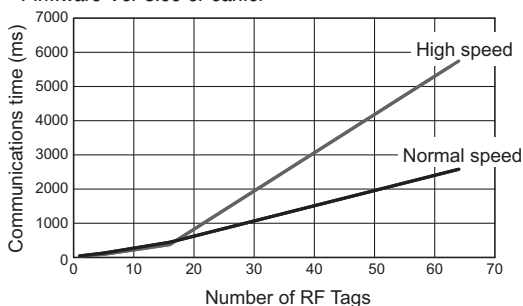

● DATA READ (Multi-access)

Reading 32 Words of Data from the User Area

• Firmware Ver 3.01 or later

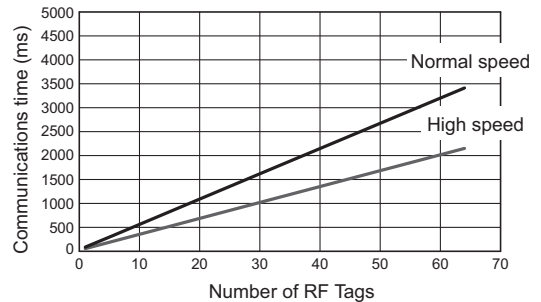

Firmware Ver 3.00 or earlier

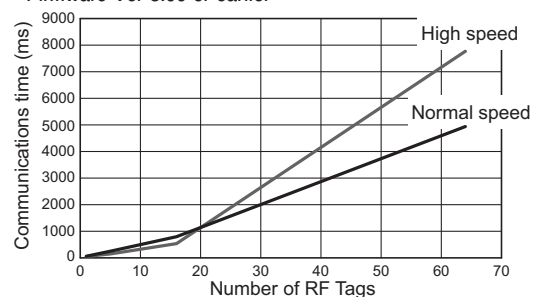

V780-HMD68-EIP-MY/V780-HMD68-ETN-MY-S

● ID READ (Single-access)

During 6-word (96bit) data readout from the UII (EPC) area

RF communications speed	Communications time
High speed	21 ms
Normal speed	27 ms

Single-access

	RF communications speed	Communications time (ms) N : No. of bytes processed
DATA READ	High speed	$T=0.33N+23.8$
	Normal speed	$T=0.68N+30.4$
DATA WRITE (with verification)	High speed	$T=12.3N+13.2$
	Normal speed	$T=15.1N+20.1$
DATA WRITE (without verification)	High speed	$T=11.9N+11.8$
	Normal speed	$T=14.4N+17.1$

Single-access

	RF communications speed	Communications time (ms) N : No. of Tags
Multi-ID READ	High speed	$T=20.3N+25.1$
	Normal speed	$T=27.7N+33.5$
Multi-DATA READ	High speed	$T=33.2N+22.0$
	Normal speed	$T=52.8N+33.6$

● DATA READ (Single-access)

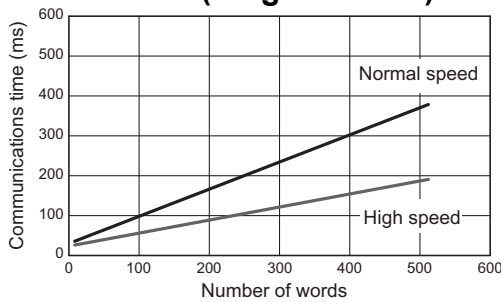

● DATA WRITE (Single-access)

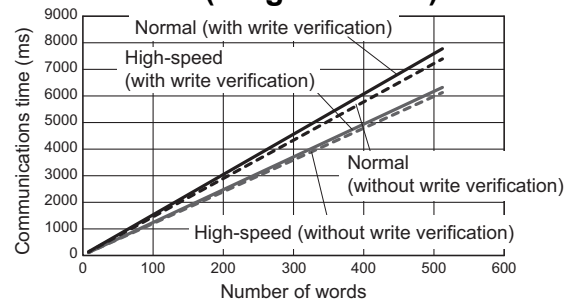

● ID READ (Multi-access)

During 6-word (96bit) data readout from the UII (EPC) area

• Firmware Ver 3.01 or later

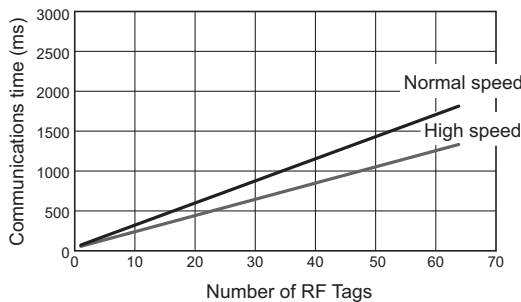

• Firmware Ver 3.00 or earlier

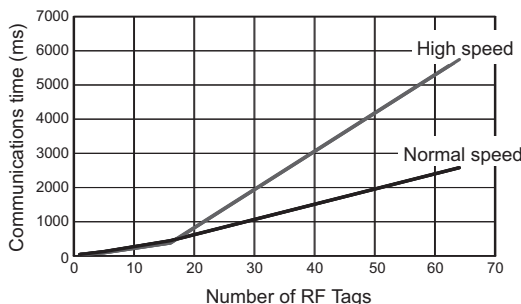

● DATA READ (Multi-access)

Reading 32 Words of Data from the User Area

• Firmware Ver 3.01 or later

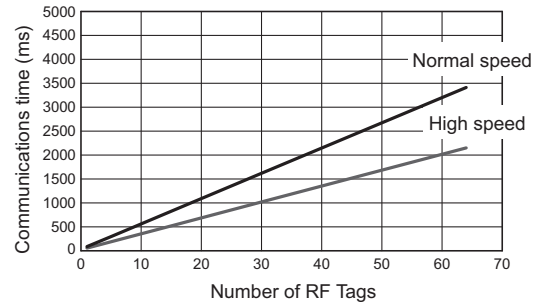

Firmware Ver 3.00 or earlier

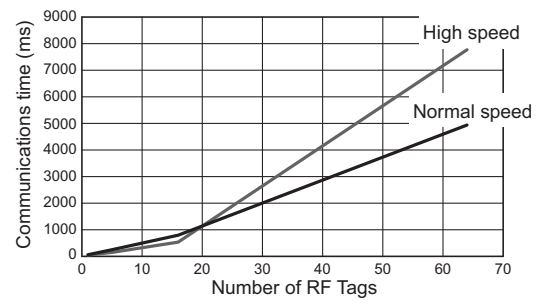

V780-HMD68-EIP-SG/V780-HMD68-ETN-SG-S

● ID READ (Single-access)

During 6-word (96bit) data readout from the UII (EPC) area

RF communications speed	Communications time
High speed	21 ms
Normal speed	27 ms

Single-access

	RF communications speed	Communications time (ms) N : No. of bytes processed
DATA READ	High speed	$T=0.33N+23.8$
	Normal speed	$T=0.68N+30.4$
DATA WRITE (with verification)	High speed	$T=12.3N+13.2$
	Normal speed	$T=15.1N+20.1$
DATA WRITE (without verification)	High speed	$T=11.9N+11.8$
	Normal speed	$T=14.4N+17.1$

Single-access

	RF communications speed	Communications time (ms) N : No. of Tags
Multi-ID READ	High speed	$T=20.3N+25.1$
	Normal speed	$T=27.7N+33.5$
Multi-DATA READ	High speed	$T=33.2N+22.0$
	Normal speed	$T=52.8N+33.6$

● DATA READ (Single-access)

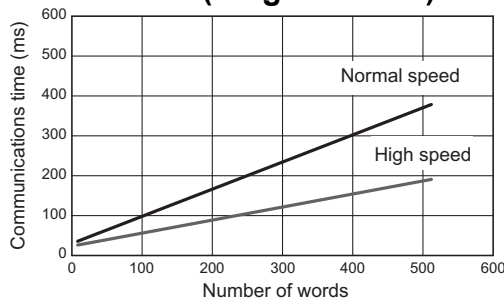

● DATA WRITE (Single-access)

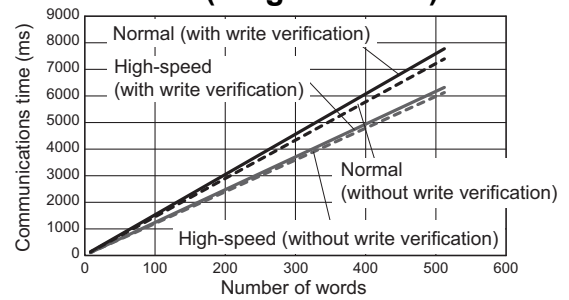

● ID READ (Multi-access)

During 6-word (96bit) data readout from the UII (EPC) area

• Firmware Ver 3.01 or later

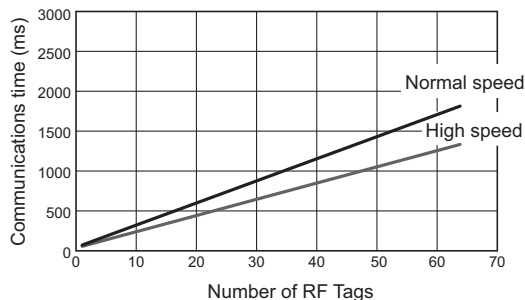

• Firmware Ver 3.00 or earlier

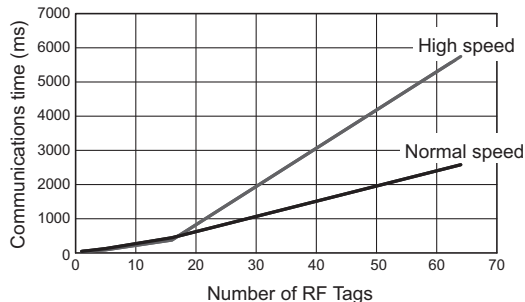

● DATA READ (Multi-access)

Reading 32 Words of Data from the User Area

• Firmware Ver 3.01 or later

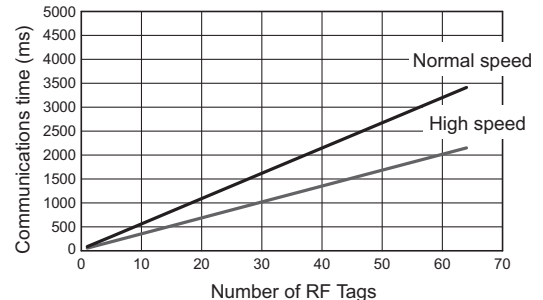

Firmware Ver 3.00 or earlier

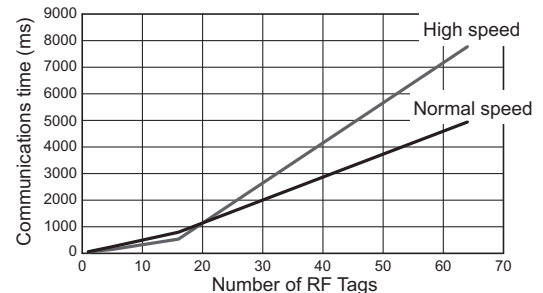

V780-HMD68-EIP-EU/V780-HMD68-ETN-EU-S

● ID READ (Single-access)

During 6-word (96bit) data readout from the Ull (EPC) area

RF communications speed	Communications time
High speed	21 ms
Normal speed	27 ms

Single-access		
	RF communications speed	Communications time (ms) N : No. of bytes processed
DATA READ	High speed	$T=0.33N+188$
	Normal speed	$T=0.69N+25.0$
DATA WRITE (with verification)	High speed	$T=11.6N+29.7$
	Normal speed	$T=14.8N+31.8$
DATA WRITE (without verification)	High speed	$T=11.2N+27.2$
	Normal speed	$T=14.0N+28.9$

Single-access		
	RF communications speed	Communications time (ms) N : No. of Tags
Multi-ID READ	High speed	$T=20.4N+23.5$
	Normal speed	$T=24.4N+25.2$
Multi-DATA READ	High speed	$T=30.1N+19.2$
	Normal speed	$T=45.2N+34.7$

● DATA READ (Single-access)

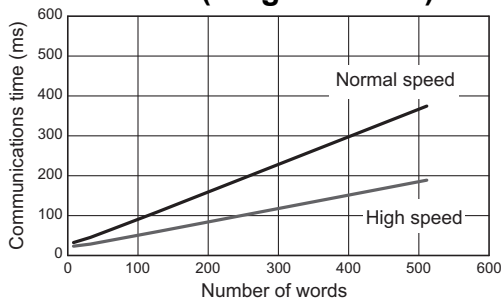

● DATA WRITE (Single-access)

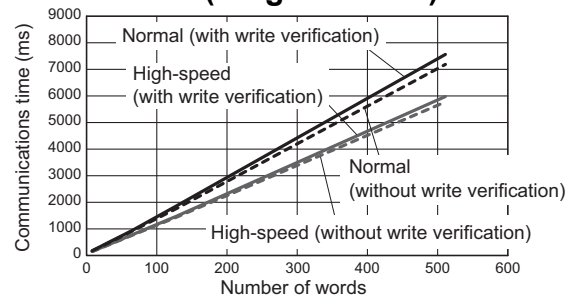

● ID READ (Multi-access)

During 6-word (96bit) data readout from the Ull (EPC) area

• Firmware Ver 3.01 or later

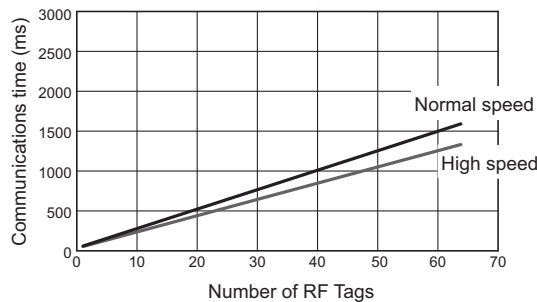

• Firmware Ver 3.00 or earlier

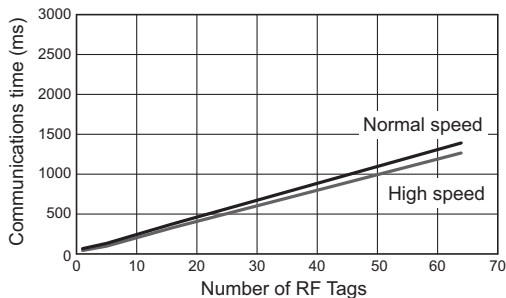

● DATA READ (Multi-access)

Reading 32 Words of Data from the User Area

• Firmware Ver 3.01 or later

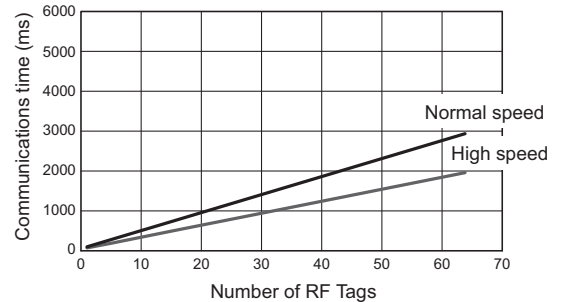

Firmware Ver 3.00 or earlier

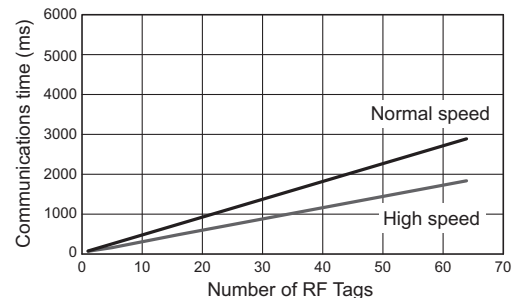

V780-HMD68-EIP-RU/V780-HMD68-ETN-RU-S

● ID READ (Single-access)

During 6-word (96bit) data readout from the UII (EPC) area

RF communications speed	Communications time
High speed	21 ms
Normal speed	27 ms

Single-access

	RF communications speed	Communications time (ms) N : No. of bytes processed
DATA READ	High speed	$T=0.33N+188$
	Normal speed	$T=0.69N+25.0$
DATA WRITE (with verification)	High speed	$T=11.6N+29.7$
	Normal speed	$T=14.8N+31.8$
DATA WRITE (without verification)	High speed	$T=11.2N+27.2$
	Normal speed	$T=14.0N+28.9$

Single-access

	RF communications speed	Communications time (ms) N : No. of Tags
Multi-ID READ	High speed	$T=20.4N+23.5$
	Normal speed	$T=24.4N+25.2$
Multi-DATA READ	High speed	$T=30.1N+19.2$
	Normal speed	$T=45.2N+34.7$

● DATA READ (Single-access)

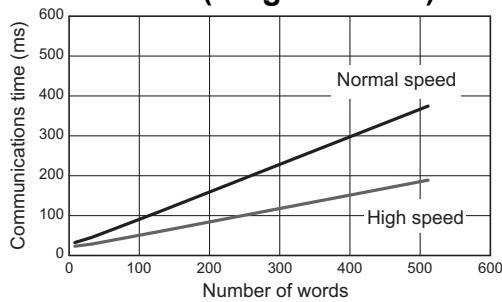

● DATA WRITE (Single-access)

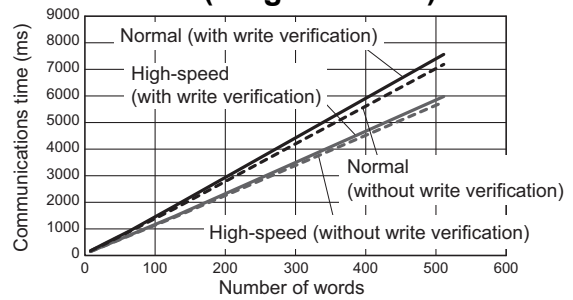

● ID READ (Multi-access)

During 6-word (96bit) data readout from the UII (EPC) area

• Firmware Ver 3.01 or later

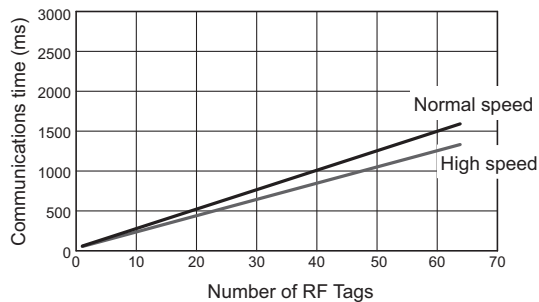

• Firmware Ver 3.00 or earlier

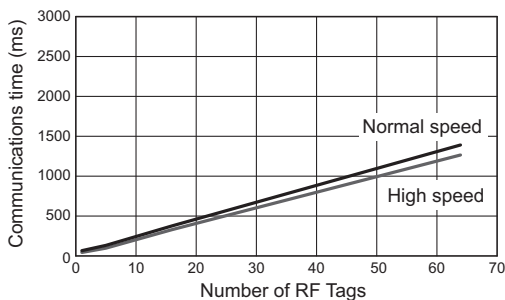

● DATA READ (Multi-access)

Reading 32 Words of Data from the User Area

• Firmware Ver 3.01 or later

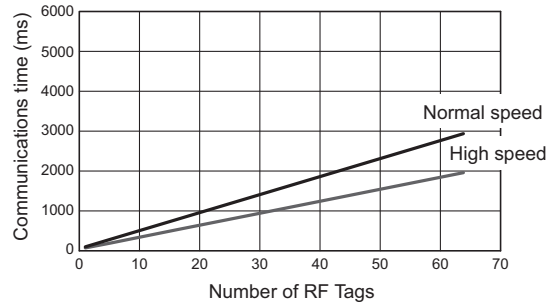

Firmware Ver 3.00 or earlier

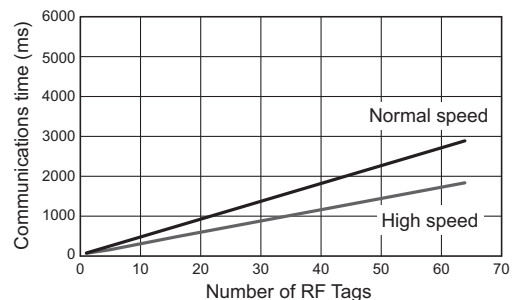

V780-HMD68-EIP-US/V780-HMD68-ETN-US-S

● ID READ (Single-access)

During 6-word (96bit) data readout from the Ull (EPC) area

RF communications speed	Communications time
High speed	21 ms
Normal speed	27 ms

	RF communications speed	Communications time (ms) N : No. of bytes processed
DATA READ	High speed	$T=0.33N+23.8$
	Normal speed	$T=0.68N+30.4$
DATA WRITE (with verification)	High speed	$T=12.3N+13.2$
	Normal speed	$T=15.1N+20.1$
DATA WRITE (without verification)	High speed	$T=11.9N+11.8$
	Normal speed	$T=14.4N+17.1$

	RF communications speed	Communications time (ms) N : No. of Tags
Multi-ID READ	High speed	$T=20.3N+25.1$
	Normal speed	$T=27.7N+33.5$
Multi-DATA READ	High speed	$T=33.2N+22.0$
	Normal speed	$T=52.8N+33.6$

● DATA READ (Single-access)

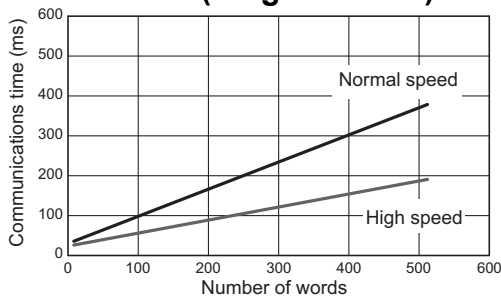

● DATA WRITE (Single-access)

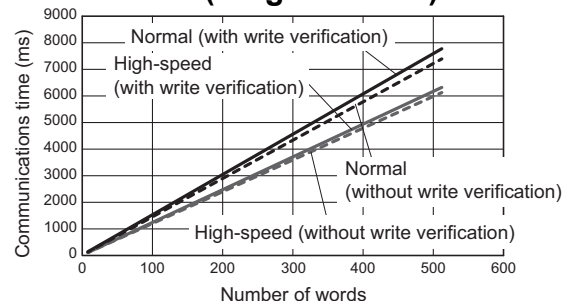

● ID READ (Multi-access)

During 6-word (96bit) data readout from the Ull (EPC) area

• Firmware Ver 3.01 or later

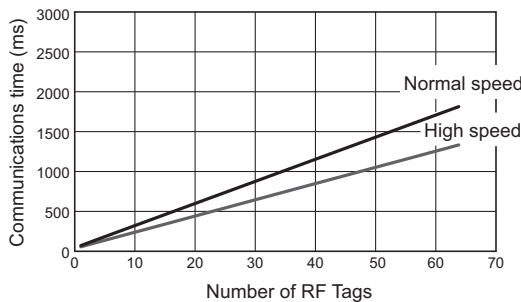

• Firmware Ver 3.00 or earlier

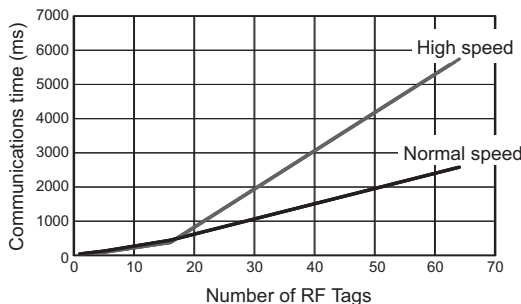

● DATA READ (Multi-access)

Reading 32 Words of Data from the User Area

• Firmware Ver 3.01 or later

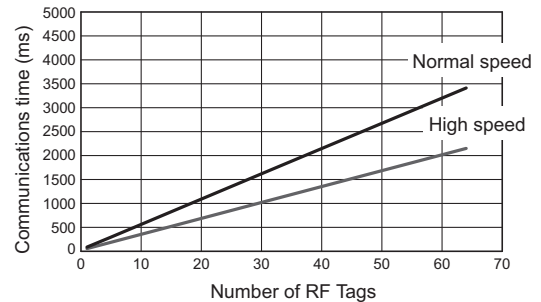

Firmware Ver 3.00 or earlier

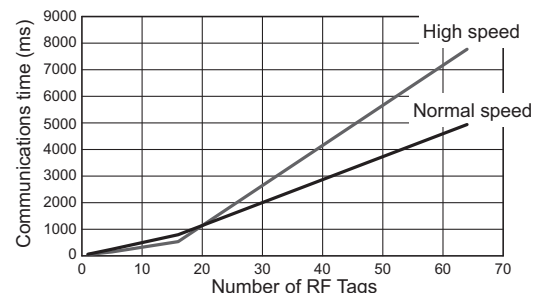

V780-HMD68-EIP-MX/V780-HMD68-ETN-MX-S

● ID READ (Single-access)

During 6-word (96bit) data readout from the UII (EPC) area

RF communications speed	Communications time
High speed	21 ms
Normal speed	27 ms

Single-access

	RF communications speed	Communications time (ms) N : No. of bytes processed
DATA READ	High speed	$T=0.33N+23.8$
	Normal speed	$T=0.68N+30.4$
DATA WRITE (with verification)	High speed	$T=12.3N+13.2$
	Normal speed	$T=15.1N+20.1$
DATA WRITE (without verification)	High speed	$T=11.9N+11.8$
	Normal speed	$T=14.4N+17.1$

Single-access

	RF communications speed	Communications time (ms) N : No. of Tags
Multi-ID READ	High speed	$T=20.3N+25.1$
	Normal speed	$T=27.7N+33.5$
Multi-DATA READ	High speed	$T=33.2N+22.0$
	Normal speed	$T=52.8N+33.6$

● DATA READ (Single-access)

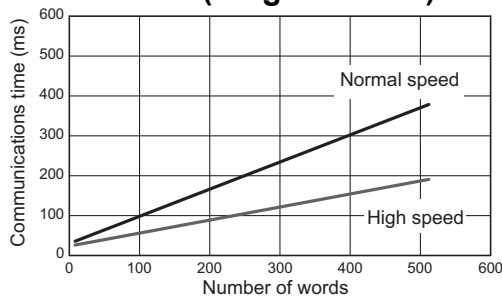

● DATA WRITE (Single-access)

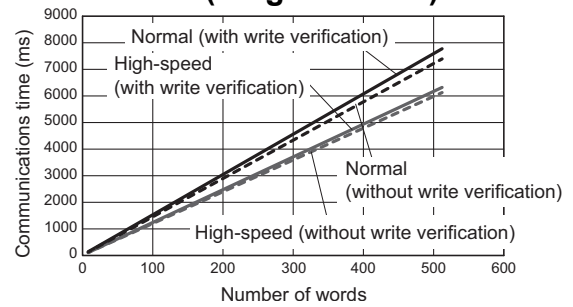

● ID READ (Multi-access)

During 6-word (96bit) data readout from the UII (EPC) area

• Firmware Ver 3.01 or later

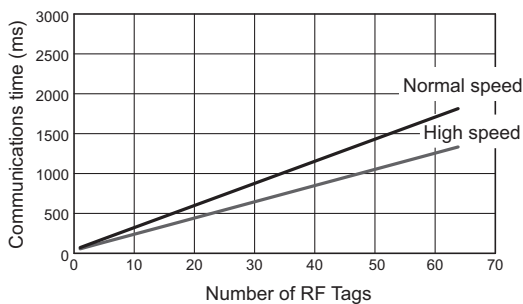

● DATA READ (Multi-access)

Reading 32 Words of Data from the User Area

• Firmware Ver 3.01 or later

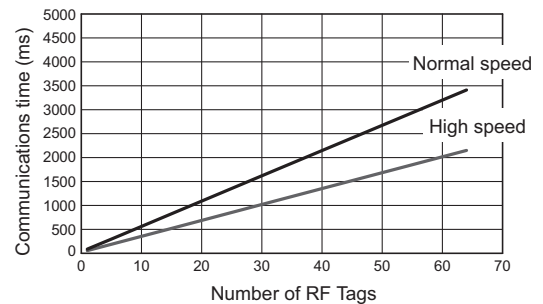

• Firmware Ver 3.00 or earlier

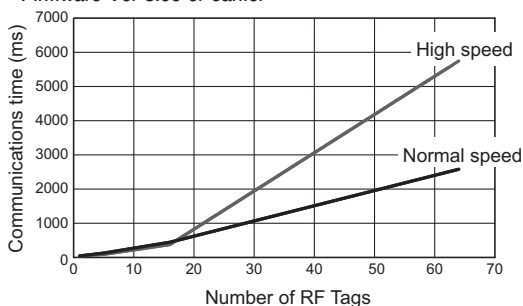

Firmware Ver 3.00 or earlier

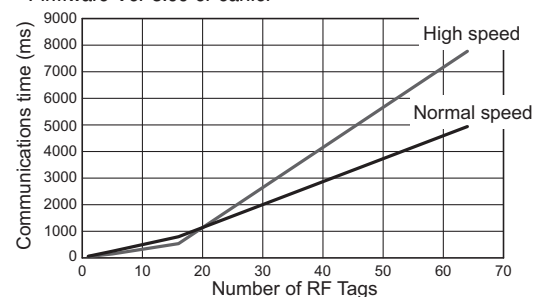

A-3 RF Tag Memory Map

Specify the addresses in the following memory map for the data pointers in the command you send to the Reader/Writer.

V780-A-JIME-Z3BLI-10 (Recommended) Memory Map

Memory bank	Bit address (hex)	Word address (hex)	Bit													
			15	14	13	12	11	10	9	8	7	6	5	4	3	
User area (bank 11)	1FF0-1FFF	1FF	USER [15 : 0]													R/W *1
													R/W *1
	00-0F	00	USER [8191 : 8176]													R/W *1
TID area (bank 10)	B0-BF	0B	RFS UII (EPC) [15 : 0]													R/W *1
													R/W *1
	60-6F	06	RFS_UII (EPC) [95 : 80]													R/W *1
	50-5F	05	TID_SERIAL [15 : 0]													RO *2
	40-4F	04	TID_SERIAL [31 : 16]													RO *2
	30-3F	03	TID_SERIAL [47 : 32]													RO *2
	20-2F	02	TDTS_ [15 : 0] := 2000 hex													RO *2
	10-1F	01	0000 (binary)	TID_MODEL[7 : 0] 15 hex (Gen2 model number is address 14 hex to 1F hex)							TID_DESIGNER [3:0] = 1000 (binary)					RO *2
00-0F	00	TID_DESIGNER [10:4] = 0000000 (binary) (Gen2 mask designer is address 08 to 13 hex.)					XTI D=1	CLASS_ID [7:0] = 01000111 (binary)								
UII (EPC) area (bank 01)	90-9F	09	UII (EPC) [15 : 0]													R/W *1
													R/W *1
	20-2F	02	UII (EPC) [127 : 112]													R/W *1
	10-1F	01	NSI[8:0] (Numbering System Identifier, default 00000000 (binary))						XI=0	UMI	UII (EPC)_LENGTH[4 : 0]					R/W *1
	00-0F	00	UII (EPC)_CRC-16 [15 : 0]													RO *2
Reserv ed area (bank 00)	A0-AF	0A	RF1 _DI S	RF2 _DI S	DCI _RF _EN	RFS _ME M	RES _SR	BPL _EN	WW U	RFU=0					RO *2	
	90-9F	09	BPERMALOCK [0:15]													RO *2
	80-8F	08	RESERVED													RO *2
													RO *2
	50-5F	05	RESERVED													RO *2
	40-4F	04	I2C_ADDR [1 : 0]	KILL	RFU=0				LOC K_D A	LOCK_USE R[1 : 0]	LOCK_EPC [1 : 0]	LOCK_AC-CESS[1 : 0]	LOCK_KILL [1 : 0]	RO *2		
	30-3F	03	ACCESS_PASSWORD [15 : 0]													R/W *1
	20-2F	02	ACCESS_PASSWORD [31 : 16]													R/W *1
	10-1F	01	KILL_PASSWORD [15 : 0]													R/W *1
	00-0F	00	KILL_PASSWORD [31 : 16]													R/W *1

*1. R/W (Read/Write): Data can be read and written for the area.

*2. RO (Read Only): Data can be read from the area but not written to it.

A-4 Communications Range Diagram, Reception Level Diagram (Reference Only)

● Communications range

The communications range differs depending on the radio regulations of each country. Moreover, the communications range may change under the influence of the ambient environment, type of RF Tags, and the items on which RF Tags are mounted. Sufficiently verify the communications range in advance.



Additional Information

The diagram shows characteristics when the mounting material is a 400 × 300 × 1 mm aluminum plate. The directional characteristics of the RF Tag will change with the size of the metal surface.

● Reception level

You can obtain the reception level from an RF Tag. The unit is dBm and values are given in 1-dB increments. The reception level will vary with the ambient environment, type of RF Tag, and the items on which RF Tags are mounted. Sufficiently verify the communications field in advance.

- Note 1. The reception level will attenuate by approx. 6 dBm when the distance between the Reader/Writer and RF Tag is doubled.
2. The obtained values were input at the edge of the Reader/Writer antenna. They are not the levels received by the antenna.



Precautions for Correct Use

The obtained values may be different in any specific application. The values obtained with RSSI also vary with the RF Tags that are used, the orientation of the RF Tags, and the ambient environment. Therefore, the reception levels in the above graphs are strictly for reference only. Use these value only as reference to confirm leeway in the RF Tag communications levels in the actual environment.

Measurement Conditions

● Communications Range Measurement Conditions

Measurement environment	Radio wave darkroom
RF Tag	V780-A-JIME-Z3BLI-10 (made by Toppan Forms Co., Ltd.)* ¹
Transmission power	27 dBm
Communications command	DATA READ and DATA WRITE

*1. The RF Tag was mounted to a V780-A-TA-133-10 Attachment.

● Reception Level Measurement Conditions

Measurement environment	Radio wave darkroom
RF Tag	V780-A-JIME-Z3BLI-10 (made by Toppan Forms Co., Ltd.)
Transmission power	27 dBm
Communications command	ID READ

V780-HMD68-EIP-JP/V780-HMD68-ETN-JP-S

● Communications range

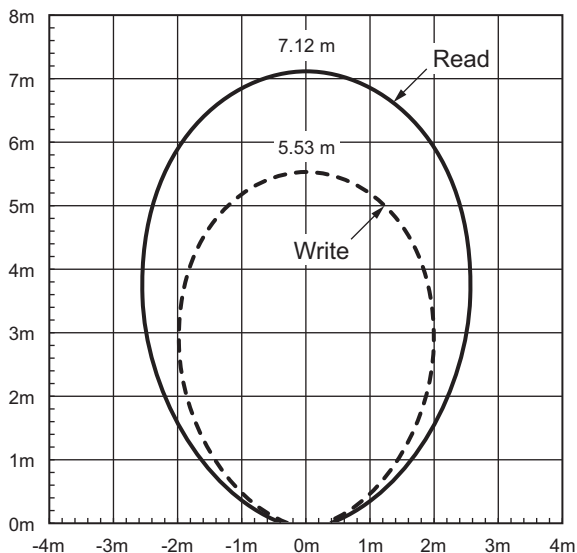

● Reception level

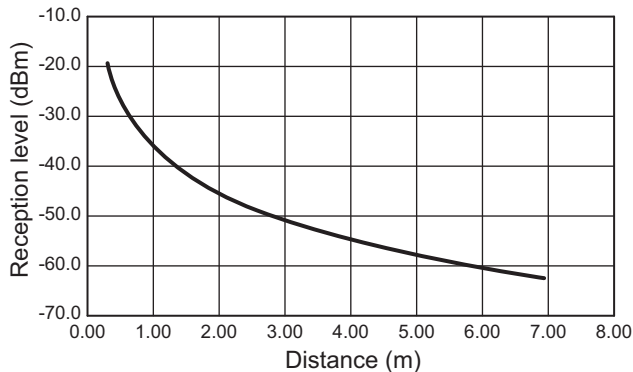

V780-HMD68-EIP-KR/V780-HMD68-ETN-KR-S

● Communications range

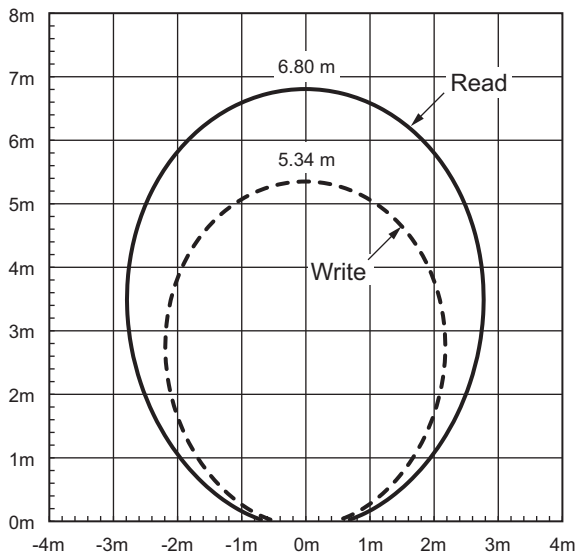

● Reception level

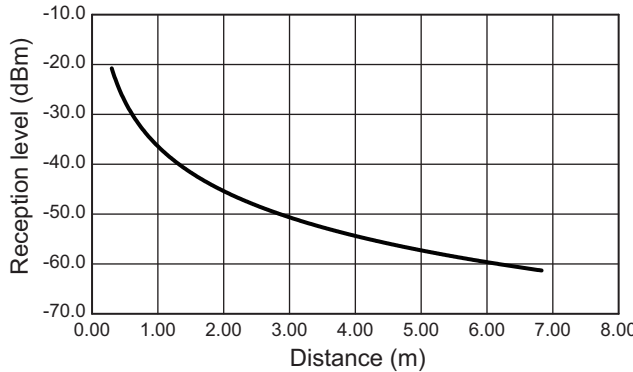

V780-HMD68-EIP-CN/V780-HMD68-ETN-CN-S

● **Communications range**

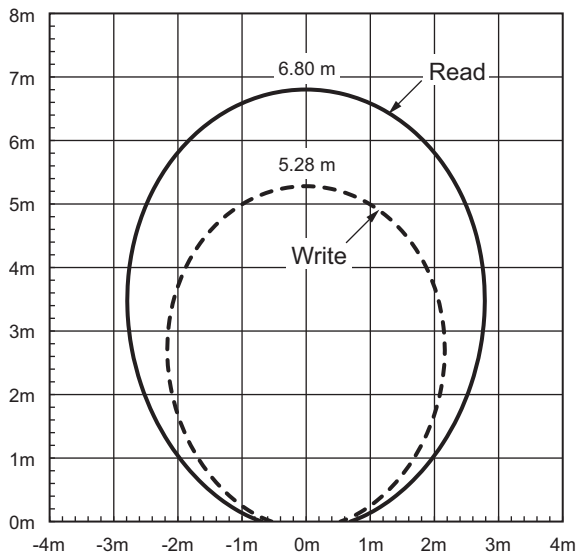

● **Reception level**

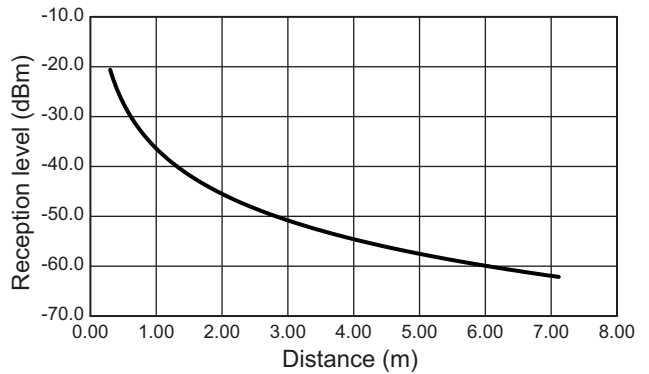

V780-HMD68-EIP-TW/V780-HMD68-ETN-TW-S

● **Communications range**

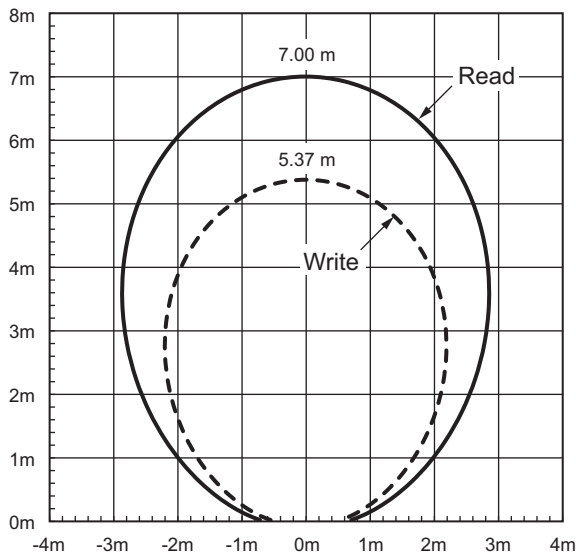

● **Reception level**

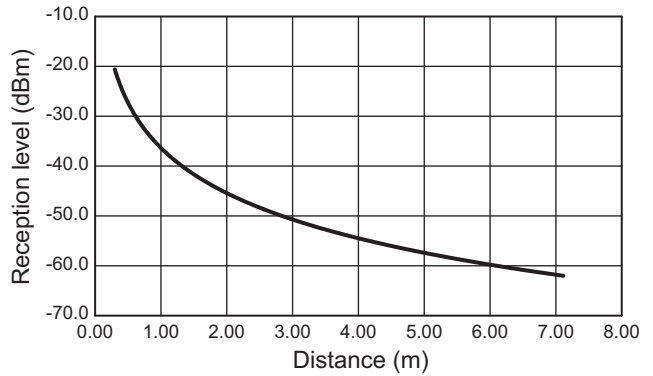

V780-HMD68-EIP-IN/V780-HMD68-ETN-IN-S

● Communications range

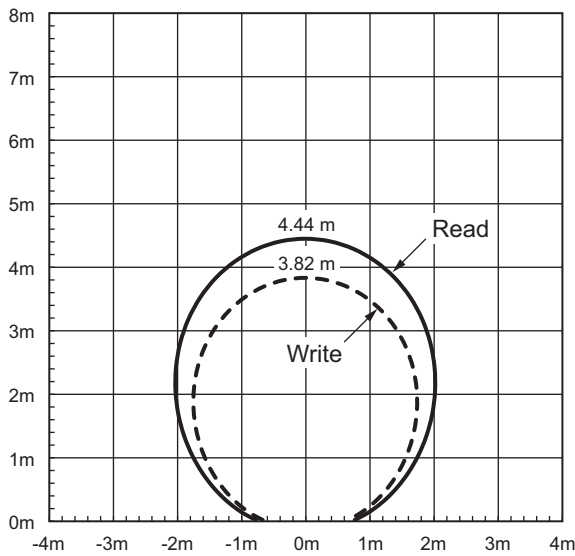

● Reception level

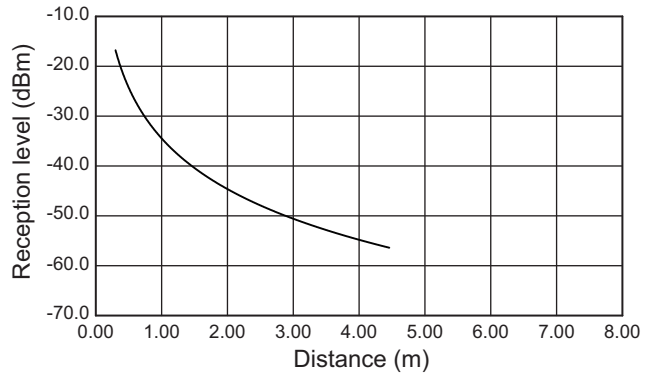

V780-HMD68-EIP-ID/V780-HMD68-ETN-ID-S

● Communications range

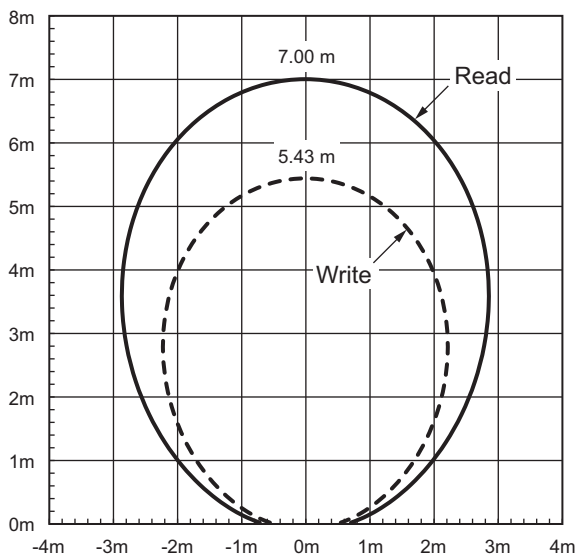

● Reception level

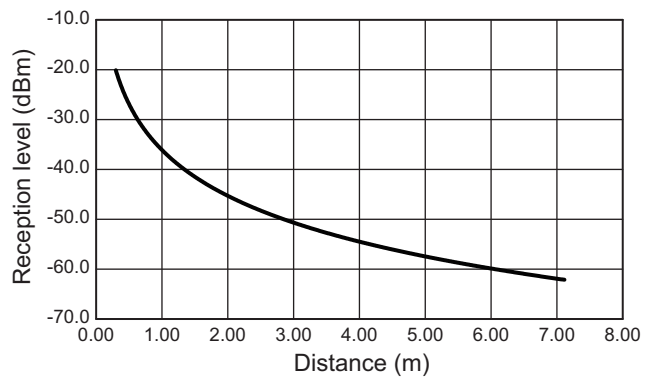

V780-HMD68-EIP-MY/V780-HMD68-ETN-MY-S

● Communications range

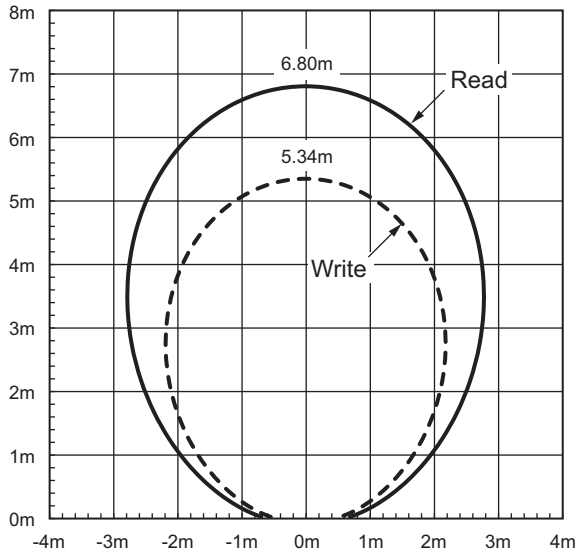

● Reception level

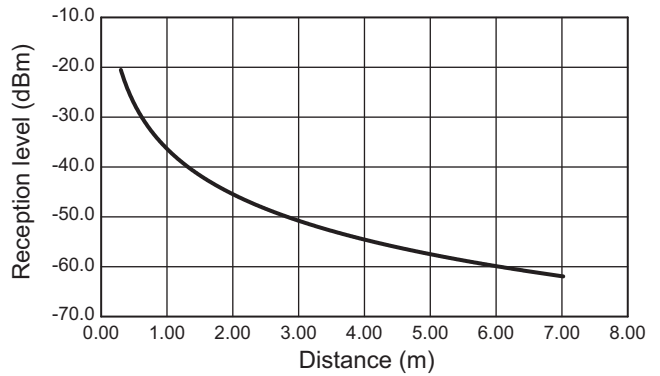

V780-HMD68-EIP-SG/V780-HMD68-ETN-SG-S

● Communications range

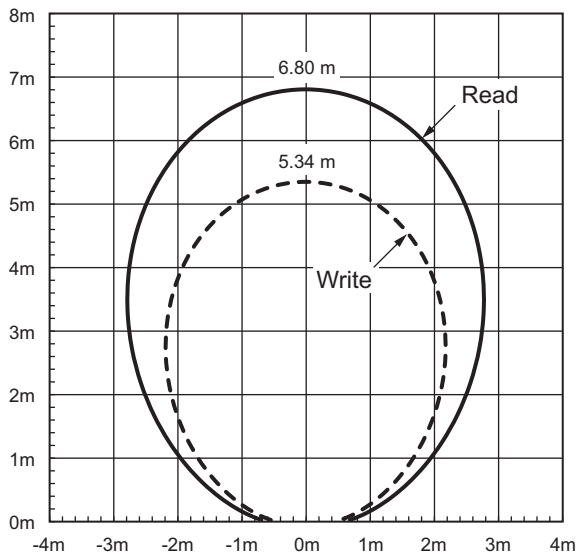

● Reception level

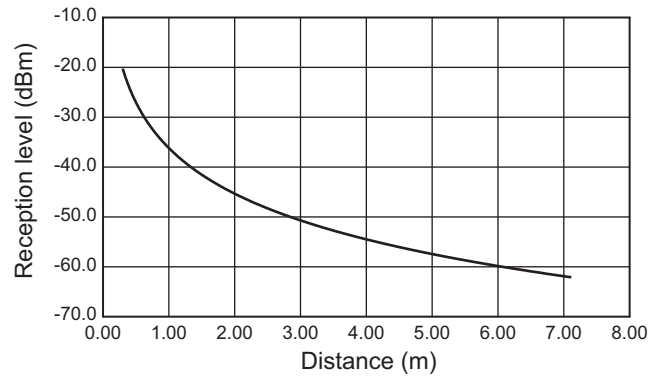

V780-HMD68-EIP-EU/V780-HMD68-ETN-EU-S

● **Communications range**

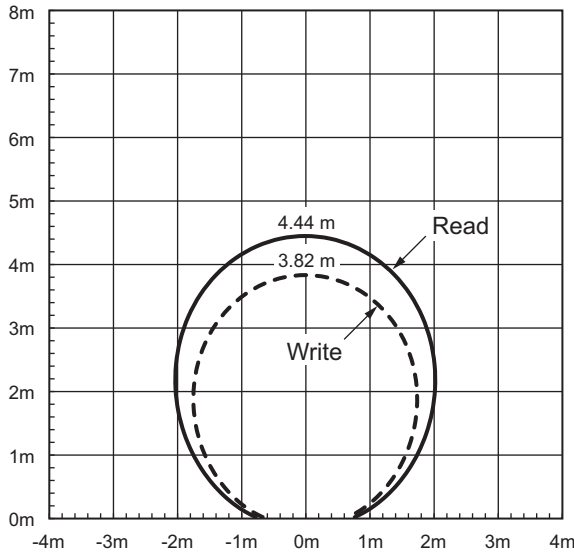

● **Reception level**

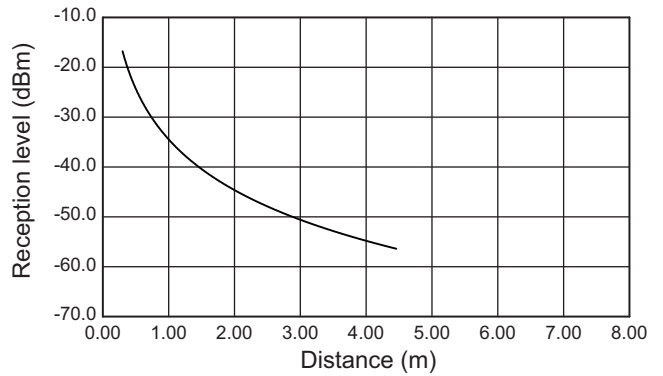

V780-HMD68-EIP-RU/V780-HMD68-ETN-RU-S

● **Communications range**

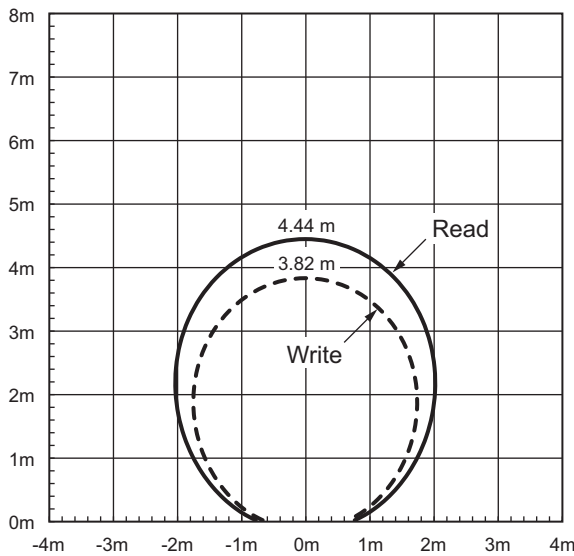

● **Reception level**

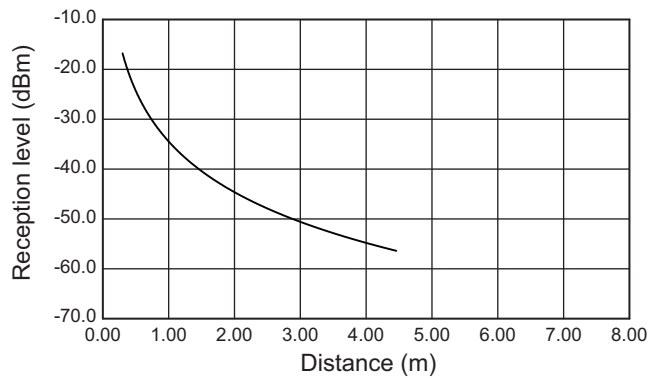

V780-HMD68-EIP-US/V780-HMD68-ETN-US-S

● Communications range

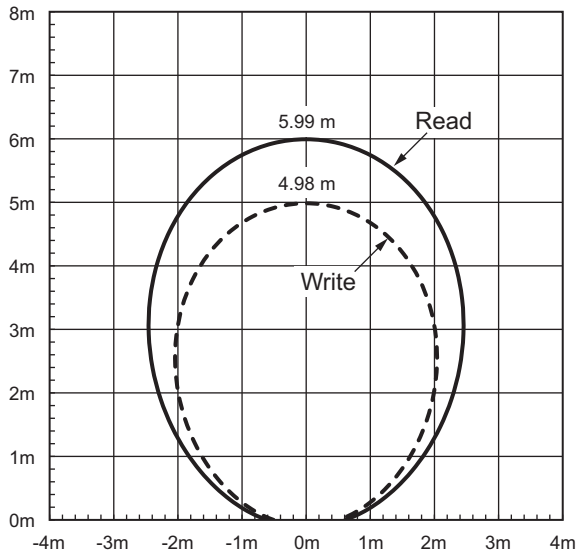

● Reception level

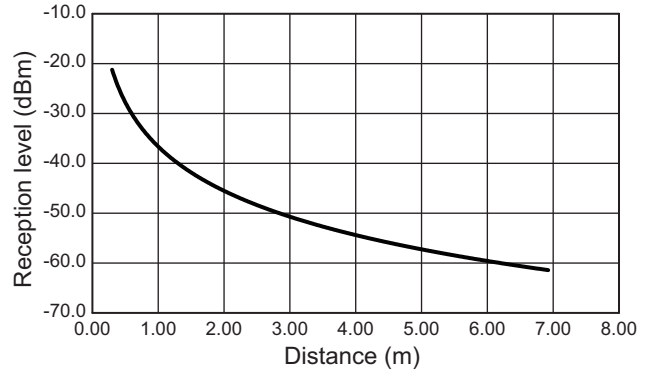

V780-HMD68-EIP-MX/V780-HMD68-ETN-MX-S

● Communications range

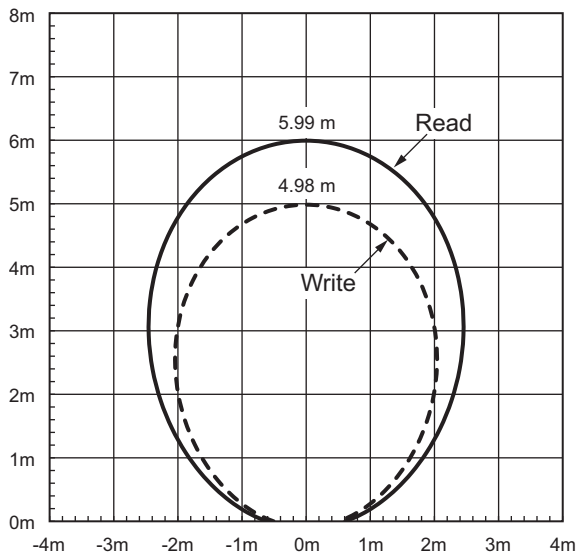

● Reception level

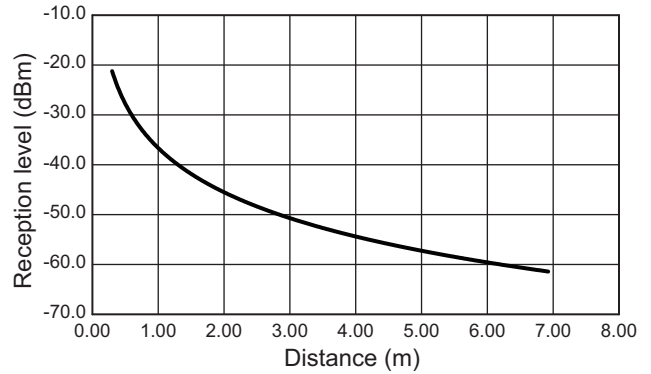

A-5 Mutual Interference of Reader/Writers (Reference Only)

If multiple Reader/Writers are installed in parallel to each other, radio wave mutual interference will affect communications with RF Tags.

When installing the Reader/Writer, refer to mounting interval described below.



Precautions for Correct Use

If the mounting interval between Reader/Writers is too short, radio wave mutual interference will cause the communications success rate to drop. The amount of mutual interference depends on the installation environment, the transmission powers of the Reader/Writers, and other factors. Sufficiently check operation in advance.

There is no need to consider the mounting interval, for Readers/Writers that are connected using the Multi-Reader/Writer function. There is no influence of mounting interval, if the Reader/Writer is attached closely.

Measurement Conditions

RF Tag	V780-A-JIME-Z3BLI-10 (made by Toppan Forms Co., Ltd.)
Distance from Reader/Writer to RF Tag	1 m (fixed)
Transmission power	27 dBm
Channel	Auto channel
RF communications speed	Auto speed
Communications command	ID READ

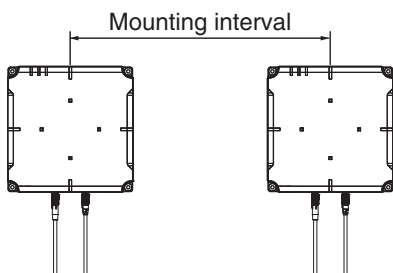

V780-HMD68-EIP-JP/V780-HMD68-ETN-JP-S

Mounting interval	Communications success rate for measurement Reader/Writer
145 cm	100%
125 cm	99%
115 cm	98%
105 cm	98%
85 cm	98%
65 cm	96%
45 cm	96%
25 cm	95%

V780-HMD68-EIP-KR/V780-HMD68-ETN-KR-S

Mounting interval	Communications success rate for measurement Reader/Writer
145 cm	100%
125 cm	98%
115 cm	96%
105 cm	90%
85 cm	81%
65 cm	77%
45 cm	77%
25 cm	77%

V780-HMD68-EIP-CN/V780-HMD68-ETN-CN-S

Mounting interval	Communications success rate for measurement Reader/Writer
145 cm	100%
125 cm	99%
115 cm	87%
105 cm	90%
85 cm	80%
65 cm	80%
45 cm	80%
25 cm	80%

V780-HMD68-EIP-TW/V780-HMD68-ETN-TW-S

Mounting interval	Communications success rate for measurement Reader/Writer
145 cm	100%
125 cm	98%
115 cm	96%
105 cm	90%
85 cm	81%
65 cm	77%
45 cm	77%
25 cm	77%

V780-HMD68-EIP-IN/V780-HMD68-ETN-IN-S

Mounting interval	Communications success rate for measurement Reader/Writer
145 cm	100%
125 cm	100%
115 cm	97%
105 cm	96%
85 cm	93%
65 cm	96%
45 cm	93%
25 cm	92%

V780-HMD68-EIP-ID/V780-HMD68-ETN-ID-S

Mounting interval	Communications success rate for measurement Reader/Writer
145 cm	100%
125 cm	98%
115 cm	96%
105 cm	90%
85 cm	81%
65 cm	77%
45 cm	77%
25 cm	77%

V780-HMD68-EIP-MY/V780-HMD68-ETN-MY-S

Mounting interval	Communications success rate for measurement Reader/Writer
145 cm	100%
125 cm	98%
115 cm	96%
105 cm	90%
85 cm	81%
65 cm	77%
45 cm	77%
25 cm	77%

V780-HMD68-EIP-SG/V780-HMD68-ETN-SG-S

Mounting interval	Communications success rate for measurement Reader/Writer
145 cm	100%
125 cm	98%
115 cm	96%
105 cm	90%
85 cm	81%
65 cm	77%
45 cm	77%
25 cm	77%

V780-HMD68-EIP-EU/V780-HMD68-ETN-EU-S

Mounting interval	Communications success rate for measurement Reader/Writer
145 cm	100%
125 cm	100%
115 cm	97%
105 cm	96%
85 cm	93%
65 cm	96%
45 cm	93%
25 cm	92%

V780-HMD68-EIP-RU/V780-HMD68-ETN-RU-S

Mounting interval	Communications success rate for measurement Reader/Writer
145 cm	100%
125 cm	100%
115 cm	97%
105 cm	96%
85 cm	93%
65 cm	96%
45 cm	93%
25 cm	92%

V780-HMD68-EIP-US/V780-HMD68-ETN-US-S

Mounting interval	Communications success rate for measurement Reader/Writer
145 cm	100%
125 cm	98%
115 cm	96%
105 cm	90%
85 cm	81%
65 cm	77%
45 cm	77%
25 cm	77%

V780-HMD68-EIP-MX/V780-HMD68-ETN-MX-S

Mounting interval	Communications success rate for measurement Reader/Writer
145 cm	100%
125 cm	98%
115 cm	96%
105 cm	90%
85 cm	81%
65 cm	77%
45 cm	77%
25 cm	77%

A-6 Chemical Resistance of the Reader/Writers

The case of a Reader/Writer is made from PBT (polybutylene terephthalate) resin and aluminum die-cast. Refer to the following lists and do not use chemicals that affect PBT resin and aluminum diecast.

Applicable Model

V780-HMD68-EIP-□□/V780-HMD68-EIP-□□-S

● Chemicals That Cause Deformations, Cracks, Etc.

Chemical names

Acetone, trichloroethylene, ethylene dichloride, sodium hydroxide, other alkaline substances, hydrochloric acid (35% or higher), and sulphuric acid (70% or higher)

● Chemicals That May Cause Discoloration, Swelling, Etc.

Chemical names

Hydrochloric acid (10% RT), acetic acid (5% RT), benzene, and nitric acid (20% or higher)



Precautions for Correct Use

- Other chemicals that are not listed above may also affect a Reader/Writer. Perform sufficient testing in advance.
- This RF Tag cannot be used in applications that require explosion-proof specifications.



Index



Index

- A**
- access password 6-28
 - advanced settings 8-10
 - Attachment 1-16, 4-4
 - Auto 6-9
- B**
- basic settings 8-9
 - BOOTP client 3-4, 3-6, 5-6
 - BOOTP server 5-6
 - browser interface 1-4, 8-1
- C**
- channel 6-27
 - channel monitor 6-56, 8-23
 - Command code 7-11
 - command error log 8-26
 - command errors 9-4
 - communications commands 6-15
 - communications diagnostics 6-40
 - communications mode 6-6
 - configuration 8-33
 - configuration file 6-35, 8-41
 - configuration files 6-35
 - connection 7-2, 7-5
 - connectors 3-15
 - control signal 6-3
- D**
- DATA FILL 6-18
 - DATA READ 6-17
 - DATA WRITE 6-17
 - device settings 6-33, 8-13
- E**
- EPC area 6-16
 - EPC Global Class1 Generation 2 standard 6-16
 - error code 9-4
 - error tables 9-4
 - EtherNet/IP 1-3, 7-2, 7-3
- F**
- Ferrite Cores 4-3
 - Field Extension Mode 6-62
 - firmware version 6-36
 - Focus 6-11
 - focus monitor 6-57, 8-24
- G**
- Gen2 session 6-28
 - general specifications 1-6
 - getting and clearing the system error log 6-37
 - getting and setting time information 6-36
 - getting the command error log 6-38
 - getting the most recent command error information 6-38
 - getting the noise level 6-39
 - getting the operating status 6-36
 - getting the reception level 6-39
- I**
- ID READ 6-17
 - ID WRITE 6-18
 - initialization 6-20
 - installation location notification 6-22
 - IP addresses 5-3
- L**
- LOCK 6-18
 - logs 8-26
- M**
- MAC address 6-36
 - maintenance (device information) 6-36
 - major faults 9-6
 - Master Reader/Writer 2-4, 6-60
 - memory bank 6-16
 - minor faults 9-6
 - multiaccess communications 6-5
 - MULTIACCESS DATA READ 6-19
 - MULTIACCESS ID READ 6-19
 - Multi-Reader/Writer Function 6-60
 - Multi-Reader/Writer Modes 6-61
- N**
- network settings 6-23, 8-6
- O**
- Once 6-6
 - operation indicator custom settings 6-33, 6-34, 8-13
 - operation indicators 3-2
 - operation modes 6-3
 - originator 7-2, 7-7, 7-8
- P**
- Password Entry View 8-4

Port settings	6-24
port settings	8-7

R

Reader/Writer	4-2
Reader/Writer controls	6-20
Reader/Writer Number	6-60
Reader/Writer settings	6-23
reading device information	6-36
reception level monitor	6-50, 8-20
recommended power supply	1-14
Repeat	6-13
RESET FOCUS	6-21
resetting	6-20
RF communications conditions (advanced settings)	6-26
RF communications conditions (basic settings)	6-24
RF communications diagnostics	6-26
RF communications diagnostics log	8-28
RF communications mode	6-24
RF communications settings	8-9
RF communications speed	6-25
RF communications timeout time	6-25
RF Tag access	6-48, 8-17
RF Tag communications	6-4
RF Tag communications errors	9-5
RF Tag scanning	6-49, 8-19
RF Tag selection filter	6-32
RF Tags	1-15, 4-4
RFID system configuration	2-2
RSSI filter	6-30
Run Mode	6-3

S

Safe Mode	6-3
single-access communications	6-4
SLAVE Mode	3-13
Slave Reader/Writer	2-4, 6-34, 6-60
SMOOTHING BUFFER	7-60, 7-61
Smoothing Buffer	6-31
Standard Reader/Writer	2-4
Status View	8-5
Switching Hub	1-3, 2-8
system error log	8-27
system errors	9-6

T

Tag Communications Specifications	1-8, 1-9, 1-10, 1-11, 1-12,	1-13
Tag Data Links	5-10	
TCP/IP settings	6-23, 8-6	
TID area	6-16	
transmission power	6-26	
transmission power tuning	6-45, 8-15	
transmission time	6-29	
tuning	6-45, 8-15	
types of errors	9-2	

U

User area	6-16
utilities	6-48, 8-17

V

V780-A-JIME-Z3BLI-10	1-15
V780-A-TA-133-10	1-16
V780-HMD68-EIP-JP	1-8

W

Web browser interface	1-4
Web password	6-24
Web password setting	8-8
write verification	6-25

OMRON Corporation Industrial Automation Company
Kyoto, JAPAN

Contact: www.ia.omron.com

Regional Headquarters

OMRON EUROPE B.V.

Wegalaan 67-69, 2132 JD Hoofddorp
The Netherlands
Tel: (31)2356-81-300/Fax: (31)2356-81-388

OMRON ELECTRONICS LLC

2895 Greenspoint Parkway, Suite 200
Hoffman Estates, IL 60169 U.S.A.
Tel: (1) 847-843-7900/Fax: (1) 847-843-7787

OMRON ASIA PACIFIC PTE. LTD.

No. 438A Alexandra Road # 05-05/08 (Lobby 2),
Alexandra Technopark,
Singapore 119967
Tel: (65) 6835-3011/Fax: (65) 6835-2711

OMRON (CHINA) CO., LTD.

Room 2211, Bank of China Tower,
200 Yin Cheng Zhong Road,
PuDong New Area, Shanghai, 200120, China
Tel: (86) 21-5037-2222/Fax: (86) 21-5037-2200

Authorized Distributor:

© OMRON Corporation 2018-2019 All Rights Reserved.
In the interest of product improvement,
specifications are subject to change without notice.

Cat. No. Z402-E1-06

1219(0718)