

NEW

Fan Ionizer

ZJ-FW Series
ZJ-FA20

OMRON

A new concept
from the production floor.



Basic fan type
ZJ-FA20



NEW Area fan type
ZJ-FW Series



Slim & Light

Area fan type ionizer that can fit anywhere



3 types

to choose from by area coverage

Slim, lightweight body

Just **6 cm** thick
1 kg* in weight

* ZJ-FW029

Area fan type

ZJ-FW Series

This ionizer series is designed to go anywhere. All models are easily installed on narrow workbenches or in high positions where earlier models presented installation issues.

Airflow vs. Ionization time

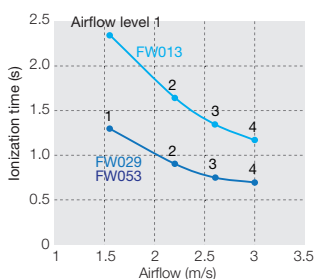

Measurement conditions
Distance from measurement point: 300 mm
Ionization time: ± 1000 V to ± 100 V
Plate monitor: 150 x 150 mm, 20 pF

Ionization area vs. Ionization time

ZJ-FW013

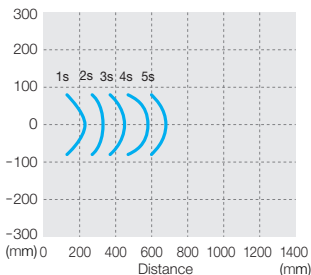

Measurement conditions
Airflow: Max.
Ionization time: ± 1000 V to ± 100 V
Plate monitor: 150 x 150 mm, 20 pF

ZJ-FW029

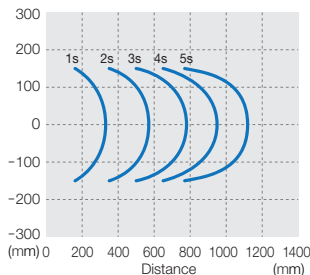

ZJ-FW053

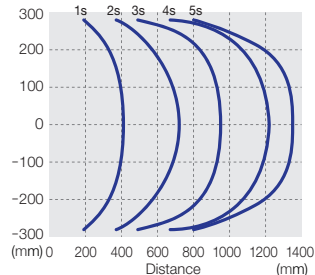

Easy to use

Standard type for a fan type ionizer with high performance

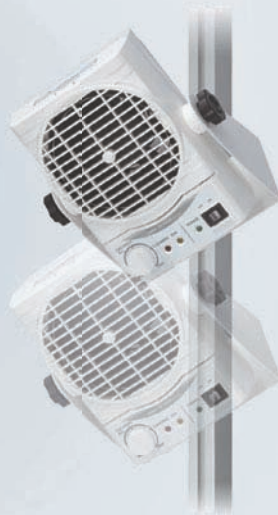

Basic fan type

ZJ-FA20

This is the standard for a fan type ionizer, which is easy-to-use and has high performance.

Pick me up, when you are not sure that what kind of fan ionizer should be used!

Various installation styles are available to match the workplace.

Airflow vs. Ionization time

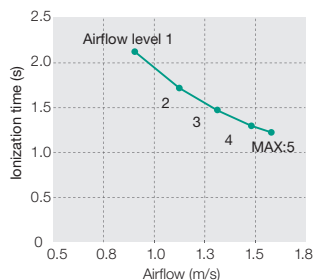

Measurement conditions
Distance from measurement point: 300 mm
Ionization time: ± 1000 V to ± 100 V
Plate monitor: 150 x 150 mm, 20 pF

Ionization area vs. Ionization time

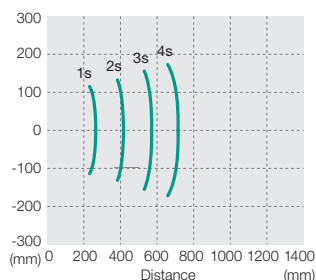

Measurement conditions
Airflow: Max.
Ionization time: ± 1000 V to ± 100 V
Plate monitor: 150 x 150 mm, 20 pF



ZJ-FW013



ZJ-FW029



ZJ-FW053

Ionization time

ZJ-FW029/053

ZJ-FW013

1.0s | 1.5s

Ion balance

±10v

Discharge method

Variable DC

(See "Ionization performance" of the ZJ-FA20.)

3 slim, lightweight types to choose from. Easy installation.

At 6 cm in depth and weighing 1 kg (ZJ-FW029), the ZJ-FW Series has pursued and achieved a slim, lightweight configuration. These ionizers easily fit on narrow workbenches or in high locations where previously they could not go. Moreover, you can select a size according to the area of coverage, so targets are uniformly neutralized.

Easy installation

Ideal for narrow workbenches to wide lines

With three sizes available, the ideal ionizer for the installation environment and ionization area can be selected. Stable uniform ionization is possible for any kind of work setup from narrow workbenches to wide lines. Moreover, tedious-to-rig air ducts used with bar type ionizers are unnecessary, which also translates into greater energy savings.

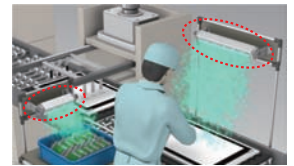
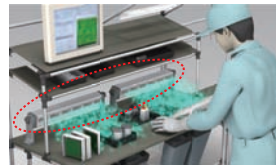

Ionizer with pipe-mounting brackets

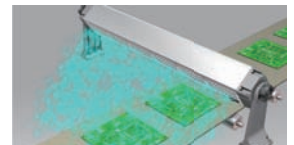

Easily installs in places where not applicable before!
(Stand, L-mounting bracket and pipe-mounting bracket available.)

Model

Model
ZJ-FW013
ZJ-FW029
ZJ-FW053

Accessories

Accessory	Model
Replacement filter (6-pack)	ZJ9-FL40FW
Replacement discharge electrode (4-electrode set)*	ZJ9-NDT04FW
Stand (Included with ZJ-FW029/053)	ZJ9-BRS1FW
L-mounting bracket (Included with ZJ-FW013)	ZJ9-BRL1FW
Pipe-mounting bracket (For mounting a 28-mm dia. pipe)	ZJ9-BRP1FW

* ZJ-FW013: 1 set, ZJ-FW029: 3 sets, ZJ-FW053: 6 sets

Rating/Performance

Item	ZJ-FW013	ZJ-FW029	ZJ-FW053
Power supply voltage	24V DC±10%, Ripple (p-p): 10%		
Current consumption	0.9A max	1.2A max	3.0A max
Discharge voltage	±7.5kV		
Discharge method	Variable DC		
Ionization time *	1.5 s	1 s	
Ion balance *	±10V max.		
Amount of ozone generated	0.01 ppm (Measured at a distance of 50 mm from air outlet)		
Indicators	Power (Green), Fan running (Green), Cleaning (Yellow), Alarm (Red)		
Main functions	Ion balance adjustment (Automatic and manual)		
External output (for both cleaning and alarm outputs)	Photo MOS relay output (NPN or PNP) • Applied voltage: 30VDC max., load current: 100mA max. • Residual voltage: 1V max		
Discharge stop input	No-voltage contact input • ON: 0V short circuit • OFF: Open (leakage current: 0.1mA max.)		
Ambient temperature range	0 to 50°C (No icing or dewing)		
Ambient humidity range	35% to 65% (No icing or dewing)		
Weight (Packaged)	Approx. 0.6 kg (Approx. 1.2 kg)	Approx. 1 kg (Approx. 1.8 kg)	Approx. 2 kg (Approx. 3 kg)
Material	Body: Aluminum, ABS Electrode needle: Tungsten		
Accessories	Instruction sheet, I/O connector, L-mounting bracket, Streamer		Instruction sheet, I/O connector, Stand, Streamer

* Typical default settings at the time of shipping from the factory

• Measurement conditions Measurement point and distance: 300 mm from body center, Airflow: Max, Plate monitor: 150 x 150 mm, 20 pF

• Ionization time: Time required to lower the charge from ±1000 V to ±100 V

• Ion balance measurement time: 10 s

Ionization performance

High speed ionization in a slim configuration

A proprietary louver structure enables a slim configuration and yet high speed ionization that removes electrostatic charge in 1 sec or less. As a standard feature, ion balance adjustment is available and airflow can be set by 4-step sliding switch. Moreover, when using the standard stand, the angle can be easily adjusted against a graduated scale.



Ion balance adjuster (Body rear)



Easy angle adjustment with graduated scale

Reliability

Four indicators and an alarm output let you easily identify the operating status.

The Ionizer's operating status is displayed on easy-to-see indicators and it can be output to an external device. Besides the power (PWR) indicator, there are a CLEAN lamp that lights when it is time for electrode needle maintenance, an ALM lamp that lights if trouble occurs, and a FAN lamp that is lit while the fan is operating.

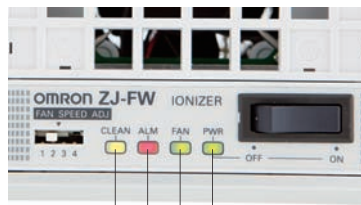

Power lamp
Fan running lamp
Alarm lamp
Cleaning notification lamp



Running status is understood at a glance. Airflow sticker included

Maintainability

Easy electrode needle replacement owing to modular structure

The ionizer adopts a full-open structure that allows users to detach the front cover by just pressing on tabs. This makes electrode needle cleaning very easy. Moreover, the electrode needles are configured as a unit that can be easily and safely replaced.



Easy electrode needle replacement



Full-open structure for easy cleaning

Input/output circuit

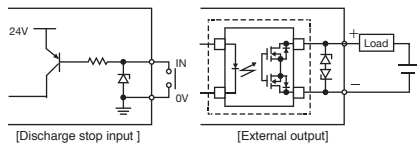

(1) Discharge stop input

When the discharge stop input is turned ON, the discharge from needles and rotation of fans stops and external output turns OFF(Open).

(2) External output

External output is ON(Close) state when ZJ-FW is working normally. External output is OFF(Open) state as one of the below conditions occurs.
• Front cover open, Cleaning, Fan rotation error, Malfunction error and Discharge stop input ON

Input and Output logic

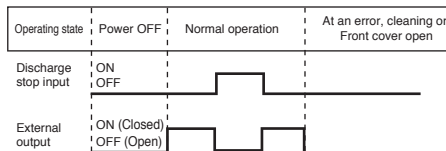

Pipe-mounting bracket ZJ9-BRP1FW (Units: mm)

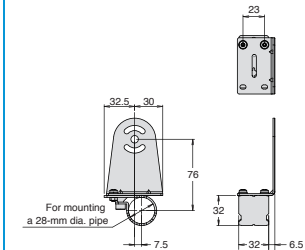

Outer dimensions ZJ-FW013 (Units: mm)

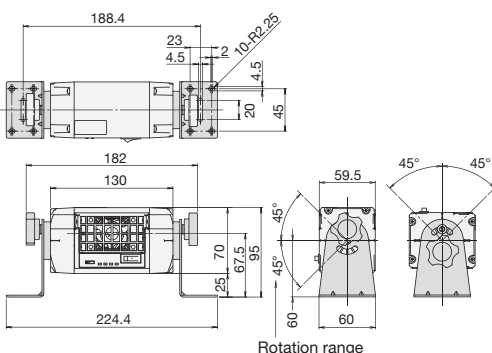

ZJ-FW029/053 (Units: mm)

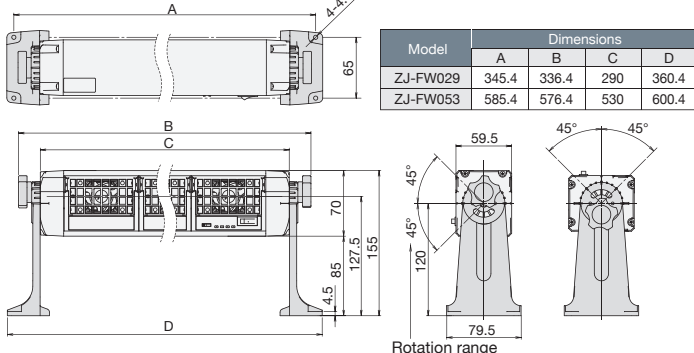



Ionization time

1.2 s

Ion balance

±10v

Discharge method

Variable DC

High speed ionization and technological sophistication at a reasonable price. Excellent cost-performance.

The ZJ-FA20 delivers technological sophistication at a low price, featuring high speed ionization that removes electrostatic charge in 1.2 s, ion balance control via a built-in sensor, and a full-open structure that makes it easy to clean and replace electrodes.

Ionization performance

High speed ionization by delivering a high density ion flow on an efficiently channeled air stream

The variable DC ionizer simultaneously generates a large quantity of ions from separate positive and negative electrode needles, while a built-in ion balance sensor controls ion quantity. The result is a good balance between high speed ionization and proper ion balance. Moreover, Omron's proprietary louver structure efficiently directs ions to the target.

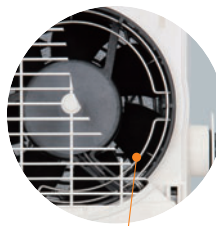

Ion balance sensor

[Variable DC ionization]

General DC ionization

Variable DC ionization

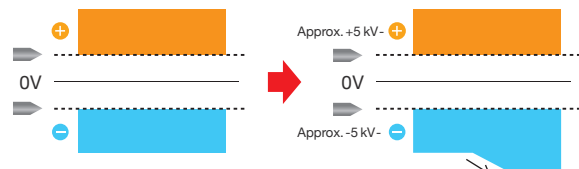

[Omron's proprietary louver structure]

Conventional ionizer

ZJ-FA20



Model

Model
ZJ-FA20

Accessories

Accessory	Model
Replacement filter (10-pack)	ZJ9-FL120N1
Replacement discharge electrode (6-pack)	ZJ9-NDT06FN1

Rating/Performance

Item	ZJ-FA20
Power supply voltage	24V DC ^{*1}
Current consumption	900 mA max. (When input by included AC adapter)
Discharge voltage	±7kV
Discharge method	Variable DC
Ionization time ^{*2}	1.2 s (0.8 s when used without filter)
Ion balance ^{*2}	±10 V max.
Amount of ozone generated	0.01 ppm (Measured at a distance of 50 mm from air outlet)
Indicators	High voltage output: ION (Yellow), Cleaning: CLEANING (Orange), Power: POWER (Green)
Main functions	Ion balance adjustment (Automatic and manual), airflow adjustment
Ambient temperature range	Working and storage: 0 to 50°C (No icing or dewing)
Ambient humidity range	Working: 35% to 65%, Storage: 35% to 85% (No icing or dewing)
Weight (Packaged)	Approx. 1.5 kg (Approx. 2 kg)
Material	Body: ABS, Electrode needle: Tungsten, Stand: SPCC
Accessories	Instruction sheet, AC adapter, Warning label (2 types), FG connection cable (2 m)

^{*1} Use the ionizer only with the included AC adapter.

^{*2} Typical default settings at time of shipping from the factory

• Measurement conditions/Measurement point and distance: 300 mm from body center, Airflow: Max, Plate monitor: 150 x 150 mm, 20 pF
• Ionization time: Time required to lower the charge from ±1000 V to ±100 V
• Ion balance measurement time: 10 s

Reliability

Ion generation understood at a glance by LED lighting

During ion generation, both the POWER and ION lamps are lit. This verifies that the ionizer is running properly. Moreover, a CLEANING lamp notifies users when it is time to clean the electrode needles.



Cleaning lamp Ion generation lamp Power lamp

Maintainability

Easy to clean and replace electrode needles

Cleaning is easy and thorough owing to a full-open structure that allows users to detach the front cover by just pressing on tabs. Electrode needles can also be easily replaced, which enables long lasting use of the product.



Full-open structure



Electrode cleaning

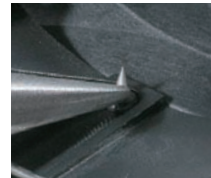

Electrode replacement

Installation

Various installation styles are available according to workplace

The ionizer can be used in a variety of postures. It can be installed on a workbench or mounted on a pole. It can also be freely angled using the angle adjustment knob on the body and the screw slots on the stand.



Front-Back tilting

Left-Right swiveling

Vertical positioning

Outer dimensions ZJ-FA20 (Units: mm)

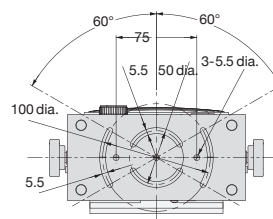
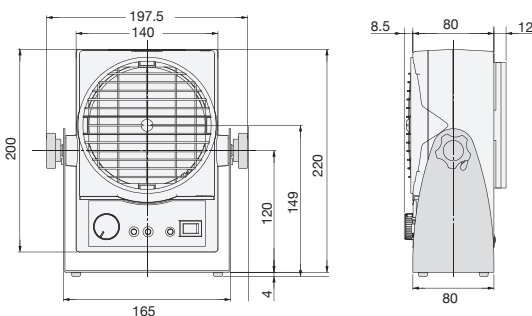

Mounting hole dimensions

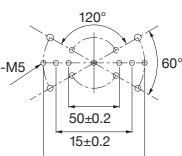

Rotation Range

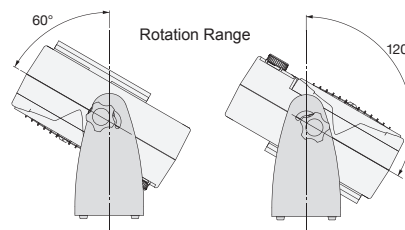

Read and Understand this Catalog

Please read and understand this catalog before purchasing the product. Please consult your OMRON representative if you have any questions or comments.

Warranty and Limitations of Liability

WARRANTY

OMRON's exclusive warranty is that the products are free from defects in materials and workmanship for a period of one year (or other period if specified) from date of sale by OMRON.

OMRON MAKES NO WARRANTY OR REPRESENTATION, EXPRESS OR IMPLIED, REGARDING NON-INFRINGEMENT, MERCHANTABILITY, OR FITNESS FOR PARTICULAR PURPOSE OF THE PRODUCTS. ANY BUYER OR USER ACKNOWLEDGES THAT THE BUYER OR USER ALONE HAS DETERMINED THAT THE PRODUCTS WILL SUITABLY MEET THE REQUIREMENTS OF THEIR INTENDED USE. OMRON DISCLAIMS ALL OTHER WARRANTIES, EXPRESS OR IMPLIED.

LIMITATIONS OF LIABILITY

OMRON SHALL NOT BE RESPONSIBLE FOR SPECIAL, INDIRECT, OR CONSEQUENTIAL DAMAGES, LOSS OF PROFITS OR COMMERCIAL LOSS IN ANY WAY CONNECTED WITH THE PRODUCTS, WHETHER SUCH CLAIM IS BASED ON CONTRACT, WARRANTY, NEGLIGENCE, OR STRICT LIABILITY.

In no event shall the responsibility of OMRON for any act exceed the individual price of the product on which liability is asserted.

IN NO EVENT SHALL OMRON BE RESPONSIBLE FOR WARRANTY, REPAIR, OR OTHER CLAIMS REGARDING THE PRODUCTS UNLESS OMRON'S ANALYSIS CONFIRMS THAT THE PRODUCTS WERE PROPERLY HANDLED, STORED, INSTALLED, AND MAINTAINED AND NOT SUBJECT TO CONTAMINATION, ABUSE, MISUSE, OR INAPPROPRIATE MODIFICATION OR REPAIR.

Application Considerations

SUITABILITY FOR USE

OMRON shall not be responsible for conformity with any standards, codes, or regulations that apply to the combination of products in the customer's application or use of the products.

At the customer's request, OMRON will provide applicable third party certification documents identifying ratings and limitations of use that apply to the products. This information by itself is not sufficient for a complete determination of the suitability of the products in combination with the end product, machine, system, or other application or use.

The following are some examples of applications for which particular attention must be given. This is not intended to be an exhaustive list of all possible uses of the products, nor is it intended to imply that the uses listed may be suitable for the products:

- Outdoor use, uses involving potential chemical contamination or electrical interference, or conditions or uses not described in this catalog.

- Nuclear energy control systems, combustion systems, railroad systems, aviation systems, medical equipment, amusement machines, vehicles, safety equipment, and installations subject to separate industry or government regulations.

- Systems, machines, and equipment that could present a risk to life or property.

Please know and observe all prohibitions of use applicable to the products.

NEVER USE THE PRODUCTS FOR AN APPLICATION INVOLVING SERIOUS RISK TO LIFE OR PROPERTY WITHOUT ENSURING THAT THE SYSTEM AS A WHOLE HAS BEEN DESIGNED TO ADDRESS THE RISKS, AND THAT THE OMRON PRODUCTS ARE PROPERLY RATED AND INSTALLED FOR THE INTENDED USE WITHIN THE OVERALL EQUIPMENT OR SYSTEM.

PROGRAMMABLE PRODUCTS

OMRON shall not be responsible for the user's programming of a programmable product, or any consequence thereof.

Disclaimers

CHANGE IN SPECIFICATIONS

Product specifications and accessories may be changed at any time based on improvements and other reasons.

It is our practice to change model numbers when published ratings or features are changed, or when significant construction changes are made. However, some specifications of the products may be changed without any notice. When in doubt, special model numbers may be assigned to fix or establish key specifications for your application on your request. Please consult with your OMRON representative at any time to confirm actual specifications of purchased products.

DIMENSIONS AND WEIGHTS

Dimensions and weights are nominal and are not to be used for manufacturing purposes, even when tolerances are shown.

PERFORMANCE DATA

Performance data given in this catalog is provided as a guide for the user in determining suitability and does not constitute a warranty. It may represent the result of OMRON's test conditions, and the users must correlate it to actual application requirements. Actual performance is subject to the OMRON Warranty and Limitations of Liability.

ERRORS AND OMISSIONS

The information in this document has been carefully checked and is believed to be accurate; however, no responsibility is assumed for clerical, typographical, or proofreading errors, or omissions.

OMRON Corporation Industrial Automation Company

Tokyo, JAPAN

Contact: www.ia.omron.com

Regional Headquarters

OMRON EUROPE B.V.

Sensor Business Unit

Carl-Benz-Str. 4, D-71154 Nufringen, Germany
Tel: (49) 7032-811-0/Fax: (49) 7032-811-199

OMRON ELECTRONICS LLC

One Commerce Drive Schaumburg,
IL 60173-5302 U.S.A.
Tel: (1) 847-843-7900/Fax: (1) 847-843-7787

OMRON ASIA PACIFIC PTE. LTD.

No. 438A Alexandra Road # 05-05/08 (Lobby 2),
Alexandra Technopark,
Singapore 119967
Tel: (65) 6835-3011/Fax: (65) 6835-2711

OMRON (CHINA) CO., LTD.

Room 2211, Bank of China Tower,
200 Yin Cheng Zhong Road,
PuDong New Area, Shanghai, 200120, China
Tel: (86) 21-5037-2222/Fax: (86) 21-5037-2200

Authorized Distributor:

© OMRON Corporation 2012 All Rights Reserved.
In the interest of product improvement,
specifications are subject to change without notice.

CSM_2_3_0517
Cat. No. E420-E1-01

0112 (0112)