

The highest level of ionization in its class.



- Sensing and variable-AC system provides fast and meticulous ionization.
- Linked Ionizers cover a wide area without causing uneven ionization.
- Digital ion display provides simple and reliable settings.



For the most recent information on models that have been certified for safety standards, refer to your OMRON website.

Refer to *Safety Precautions* on page 4.

System Configuration

Ionizer ZJ-BAS

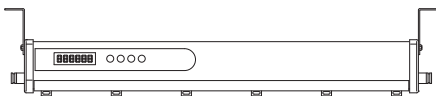

I/O Cable ZJ-BAS-FC

Used for connecting external devices.



Power supply cable

Select from the two available types.

Cable with Connector on One End ZJ-BAS-MC□□A **Cable with Connectors on Both Ends** ZJ-BAS-MC□□B

Used when using a DC power supply. Used when using an AC adapter.



AC Adapter ZJ-BAS-PS01



Special Remote Control

Remote Control
ZJ-BAS-R01



Remote Control Receiver
ZJ-BAS-R02

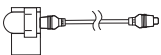

When Linking Ionizers

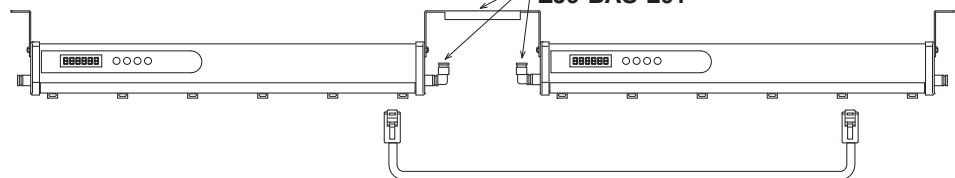

Linking Bracket Set ZJ9-BAS-L01

Power Supply Cable (for linking ionizers) ZJ-BAS-MC□□RB



The length of the cables that can be linked depends on the number of ionizers to be linked together. Contact your OMRON sales representative for details.

Ordering Information

Ionizer

Appearance	Total length	Effective length	Model
	370 mm	500 mm	ZJ-BAS050
	450 mm	580 mm	ZJ-BAS058
	610 mm	740 mm	ZJ-BAS074
	770 mm	900 mm	ZJ-BAS090
	1,170 mm	1,300 mm	ZJ-BAS130
	1,410 mm	1,540 mm	ZJ-BAS154

Power Supply Cable

Appearance	Type	Cable length	Model
	Cable with Connector on One End (one ferrite core provided, 30-dia × 39 mm)	2 m	ZJ-BAS-MC02A
		5 m	ZJ-BAS-MC05A
		10 m	ZJ-BAS-MC10A
		15 m	ZJ-BAS-MC15A
		20 m	ZJ-BAS-MC20A
	Cable with Connectors on Both Ends (one ferrite core provided, 30-dia × 39 mm)	2 m	ZJ-BAS-MC02B
		5 m	ZJ-BAS-MC05B
		10 m	ZJ-BAS-MC10B
		15 m	ZJ-BAS-MC15B
		20 m	ZJ-BAS-MC20B
	Used for connecting ionizers	710 mm	ZJ-BAS-MC07RB
		790 mm	ZJ-BAS-MC08RB
		950 mm	ZJ-BAS-MC09RB
		1,110 mm	ZJ-BAS-MC11RB
		1,510 mm	ZJ-BAS-MC15RB
		1,750 mm	ZJ-BAS-MC17RB



I/O Cable

Appearance	Cable length	Model
	2 m	ZJ-BAS-FC02A
	5 m	ZJ-BAS-FC05A
	10 m	ZJ-BAS-FC10A
	15 m	ZJ-BAS-FC15A
	20 m	ZJ-BAS-FC20A

AC Adapter

Appearance	Specifications	Model
	Input: 100 to 240 VAC Output: 24 VDC × 2	ZJ-BAS-PS01

Special Remote Control

Appearance	Type	Model
	Remote Control	ZJ-BAS-R01
	Remote Control Receiver (Receiver, USB cable, bracket)	ZJ-BAS-R02

Linking Bracket Set

Appearance	Contents	Model
	Linking Bracket (1) 6-dia. Elbow Air Joint (×2)	ZJ9-BAS-L01

Discharge Electrode Module

Appearance	Quantity	Model
	Set of 5	ZJ9-BAS-NT105
	Set of 10	ZJ9-BAS-NT110

Ratings and Specifications

Ionizer

Item	Model	ZJ-BAS050	ZJ-BAS058	ZJ-BAS074	ZJ-BAS090	ZJ-BAS130	ZJ-BAS154
Ionizer length (mm)		370	450	610	770	1,170	1,410
Effective ionization length (mm) *1		500	580	740	900	1,300	1,540
Power supply voltage	24 VDC \pm 10%, ripple (p-p) 10% max.						
Current consumption	520 mA max. (discharge frequency 0.08 to 0.5 Hz: 400 mA (typical), 1 to 10 Hz: 350 mA (typical), 20 to 40 Hz: 300 mA (typical))						
Discharge method	Sensing and a Variable-AC System						
Discharge voltage	6.5 kV P-P						
Discharge electrode	Tungsten electrode						
Recommended installation distance	50 to 2,000 mm						
Ion balance *2	\pm 30 V max.						
Power supply connector	Modular type, 8-pin connector (at both ends of Unit)						
Air inlet	6-dia one-touch coupling (at both ends of Unit)						
Maximum air pressure	0.3 MPa max.						
External I/O	Input	Discharge stop input (Turns ON at 12 to 24 VDC), input impedance: 8.2 k Ω					
	Output	Discharge stop output, cleaning output, alarm output, high-pressure error output: Signal output from photo MOS relay (100 mA max at 24 VDC)					
Display	Seven-segment LED display						
ID number	001 to 050						
Ion balance adjustment function	Yes						
Maximum number of linkable units	7 Units						
Material	Ionizer: ABS-resin, facing electrodes: Stainless steel						
Ambient temperature range	Operating: 10 to 40°C, Storage: 0 to 40°C (with no icing or condensation)						
Ambient humidity range	Operating: 35% to 65%, Storage: 35% to 85% (with no condensation)						
Weight (ionizer only)	Approx. 0.58 kg	Approx. 0.64 kg	Approx. 0.8 kg	Approx. 0.94 kg	Approx. 1.28 kg	Approx. 1.5 kg	
Accessories	Two mounting brackets, two M4 screws, instruction manual					Two mounting brackets, two M4 screws, 1 medium bracket, instruction manual	

*1. Measurement conditions
 Installation distance: 50 mm
 Airflow: 1 L /min per hole
 Frequency: 10 Hz
 Charge plate monitor: 150 × 150 mm, 20 pF
 Ionization time: (1,000 V \rightarrow 100V/-1,000V \rightarrow 100V): 1 s max.)

*2. Measurement conditions
 Installation distance: 300 mm
 Airflow: 1 L /min per hole
 Frequency: 10 Hz
 Charge plate monitor: 150 × 150 mm, 20 pF

AC Adapter

Item	Model	ZJ-BAS-PS01
Input voltage		100 to 240 VAC
Input current		1.2 A max.
Output voltage		24 VDC
Output current		3.75 A max.
Number of output ports		2 ports
Product configuration		Adapter box, AC adapter AC power cable
Weight (without package)		Adapter box: Approx. 30 g AC Adapter: Approx. 475 g AC power supply cable: Approx. 260 g

Special Remote Control

Item	Model	ZJ-BAS-R01	ZJ-BAS-R02
Product configuration		Remote Control only	Receiver Cable (150 mm) Brackets (not including Remote Control)
Communications method		Infrared communications	
Number of detectable Units		50 Units	-
Power supply		Three AAA batteries	Supplied from the ZJ-BAS Ionizer
Weight (not including packaging)		Approx. 115 g	Receiver: Approx. 5 g Cable: Approx. 6 g Bracket: Approx. 5 g
Accessories		Instruction manual	

Engineering Data (Reference Value)

Relationship of Air Pressure and Installation Distance to Ionization Time

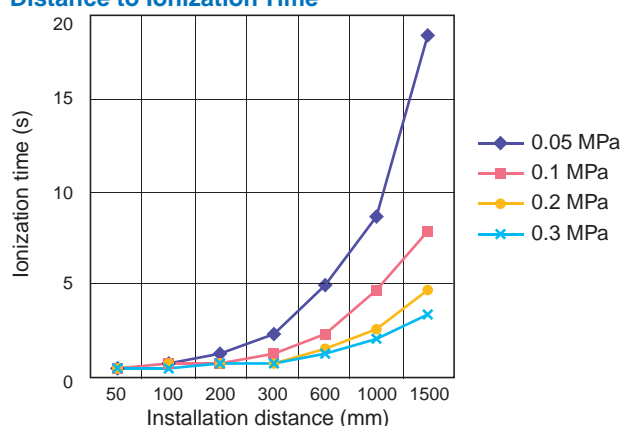

Bar Length vs. Air Pressure and Airflow

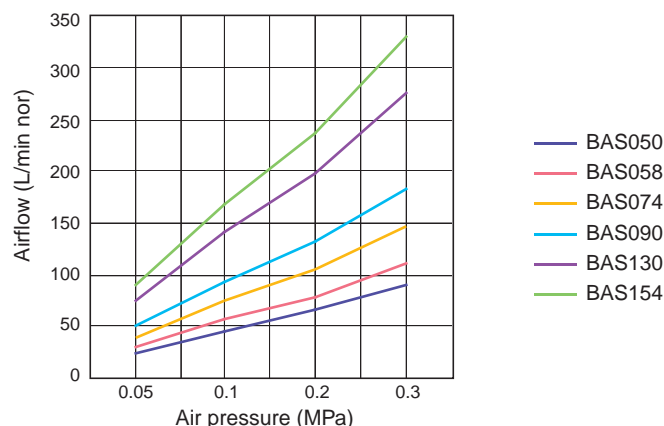

Ionization Time for Each Ionization Area

With installation distance of 50 mm (reference value)

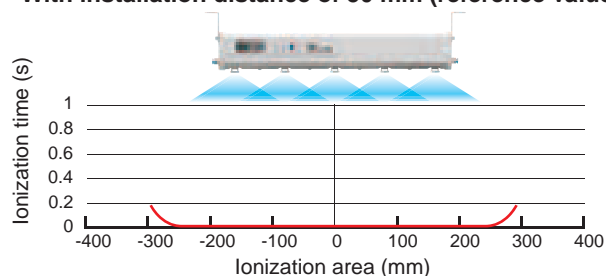

With installation distance of 1,500 mm (reference value)

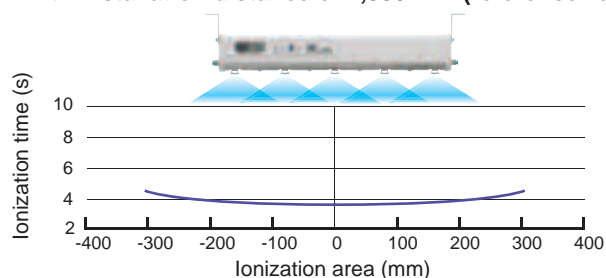

Safety Precautions

⚠ WARNING

This product is not designed or rated for ensuring safety of persons either directly or indirectly. Do not use it for such purposes.



Precaution for Correct Use

Do not use the product in atmospheres or environments that exceed product ratings.

This document provides information mainly for selecting suitable models. Information such as the usage precautions is not contained herein. Be sure to read the instruction manual before using the product.

For technical information and product FAQs, refer to the *Technical Guide* on your OMRON website.

Dimensions

Tolerance class IT16 applies to dimensions in this data sheet unless otherwise specified.

Ionizer

The dimensions and number of Discharge Electrode Modules for each model are shown in the following table.

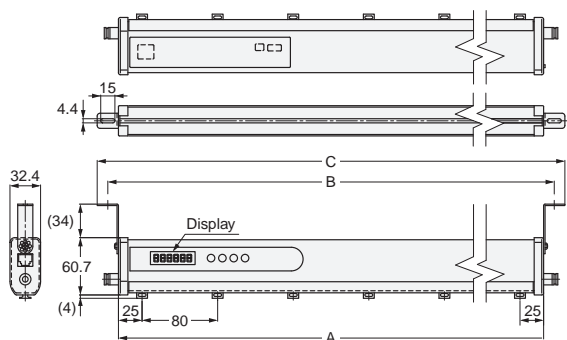

Model	A (mm)	B (mm)	C (mm)	Discharge Electrode Module
ZJ-BAS050	370	394	416	5
ZJ-BAS058	450	474	496	6
ZJ-BAS074	610	634	656	8
ZJ-BAS090	770	794	816	10
ZJ-BAS130	1,170	1,194	1,216	15
ZJ-BAS154	1,410	1,434	1,456	18

Mounting bracket

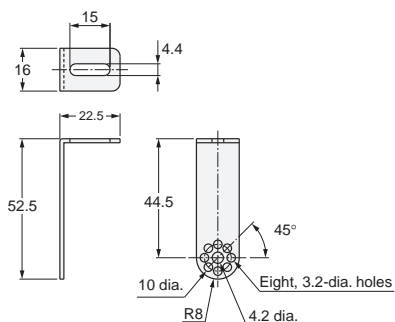

Auxiliary mounting bracket Provided with the ZJ-BAS130/BAS154

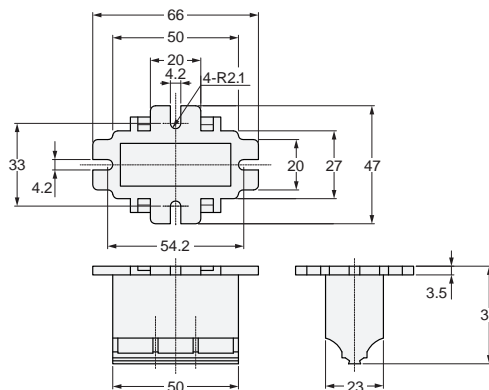

Power Supply Cable

ZJ-BAS-MC□□A

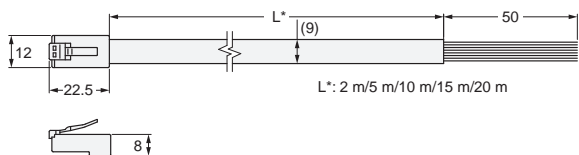

ZJ-BAS-MC□□B/MC□□RB

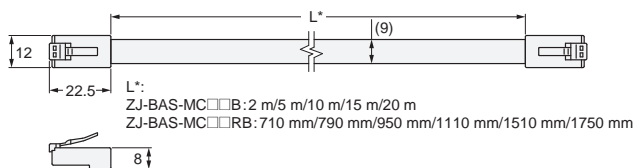

I/O Cable

ZJ-BAS-FC□□A

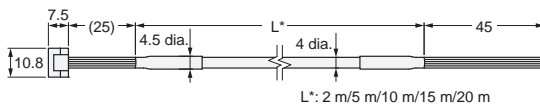

AC Adapter (Adapter box) ZJ-BAS-PS01

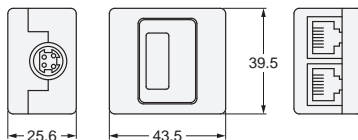

Remote Control
ZJ-BAS-R01

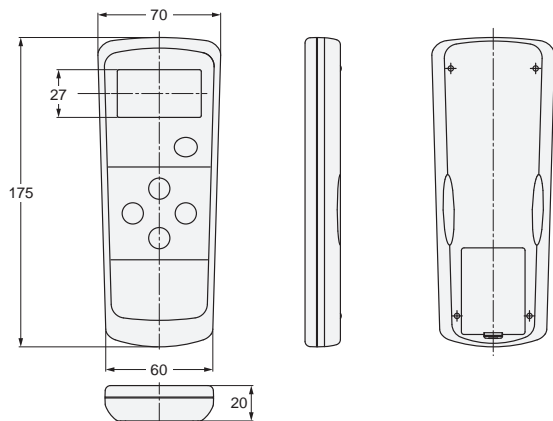

Receiver for the Remote Control (Bracket)
ZJ-BAS-R02

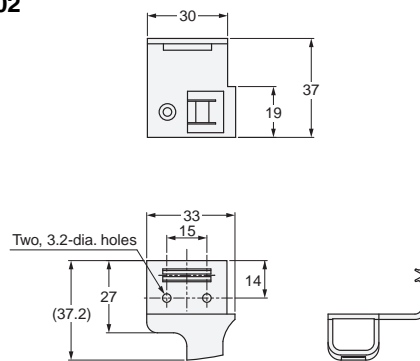

Linking Bracket
ZJ9-BAS-L01

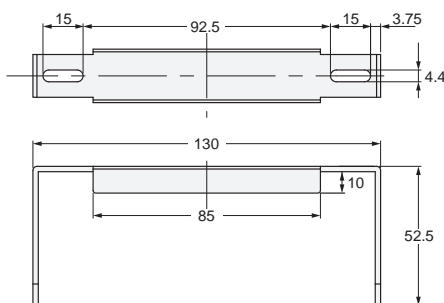

Material: Stainless steel (SUS304)

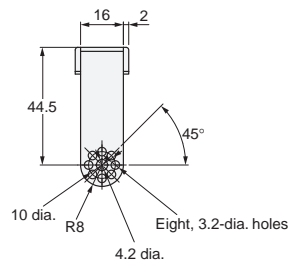

Terms and Conditions Agreement

Read and understand this catalog.

Please read and understand this catalog before purchasing the products. Please consult your OMRON representative if you have any questions or comments.

Warranties.

(a) Exclusive Warranty. Omron's exclusive warranty is that the Products will be free from defects in materials and workmanship for a period of twelve months from the date of sale by Omron (or such other period expressed in writing by Omron). Omron disclaims all other warranties, express or implied.

(b) Limitations. OMRON MAKES NO WARRANTY OR REPRESENTATION, EXPRESS OR IMPLIED, ABOUT NON-INFRINGEMENT, MERCHANTABILITY OR FITNESS FOR A PARTICULAR PURPOSE OF THE PRODUCTS. BUYER ACKNOWLEDGES THAT IT ALONE HAS DETERMINED THAT THE PRODUCTS WILL SUITABLY MEET THE REQUIREMENTS OF THEIR INTENDED USE.

Omron further disclaims all warranties and responsibility of any type for claims or expenses based on infringement by the Products or otherwise of any intellectual property right. (c) Buyer Remedy. Omron's sole obligation hereunder shall be, at Omron's election, to (i) replace (in the form originally shipped with Buyer responsible for labor charges for removal or replacement thereof) the non-complying Product, (ii) repair the non-complying Product, or (iii) repay or credit Buyer an amount equal to the purchase price of the non-complying Product; provided that in no event shall Omron be responsible for warranty, repair, indemnity or any other claims or expenses regarding the Products unless Omron's analysis confirms that the Products were properly handled, stored, installed and maintained and not subject to contamination, abuse, misuse or inappropriate modification. Return of any Products by Buyer must be approved in writing by Omron before shipment. Omron Companies shall not be liable for the suitability or unsuitability or the results from the use of Products in combination with any electrical or electronic components, circuits, system assemblies or any other materials or substances or environments. Any advice, recommendations or information given orally or in writing, are not to be construed as an amendment or addition to the above warranty.

See <http://www.omron.com/global/> or contact your Omron representative for published information.

Limitation on Liability; Etc.

OMRON COMPANIES SHALL NOT BE LIABLE FOR SPECIAL, INDIRECT, INCIDENTAL, OR CONSEQUENTIAL DAMAGES, LOSS OF PROFITS OR PRODUCTION OR COMMERCIAL LOSS IN ANY WAY CONNECTED WITH THE PRODUCTS, WHETHER SUCH CLAIM IS BASED IN CONTRACT, WARRANTY, NEGLIGENCE OR STRICT LIABILITY.

Further, in no event shall liability of Omron Companies exceed the individual price of the Product on which liability is asserted.

Suitability of Use.

Omron Companies shall not be responsible for conformity with any standards, codes or regulations which apply to the combination of the Product in the Buyer's application or use of the Product. At Buyer's request, Omron will provide applicable third party certification documents identifying ratings and limitations of use which apply to the Product. This information by itself is not sufficient for a complete determination of the suitability of the Product in combination with the end product, machine, system, or other application or use. Buyer shall be solely responsible for determining appropriateness of the particular Product with respect to Buyer's application, product or system. Buyer shall take application responsibility in all cases.

NEVER USE THE PRODUCT FOR AN APPLICATION INVOLVING SERIOUS RISK TO LIFE OR PROPERTY OR IN LARGE QUANTITIES WITHOUT ENSURING THAT THE SYSTEM AS A WHOLE HAS BEEN DESIGNED TO ADDRESS THE RISKS, AND THAT THE OMRON PRODUCT(S) IS PROPERLY RATED AND INSTALLED FOR THE INTENDED USE WITHIN THE OVERALL EQUIPMENT OR SYSTEM.

Programmable Products.

Omron Companies shall not be responsible for the user's programming of a programmable Product, or any consequence thereof.

Performance Data.

Data presented in Omron Company websites, catalogs and other materials is provided as a guide for the user in determining suitability and does not constitute a warranty. It may represent the result of Omron's test conditions, and the user must correlate it to actual application requirements. Actual performance is subject to the Omron's Warranty and Limitations of Liability.

Change in Specifications.

Product specifications and accessories may be changed at any time based on improvements and other reasons. It is our practice to change part numbers when published ratings or features are changed, or when significant construction changes are made. However, some specifications of the Product may be changed without any notice. When in doubt, special part numbers may be assigned to fix or establish key specifications for your application. Please consult with your Omron's representative at any time to confirm actual specifications of purchased Product.

Errors and Omissions.

Information presented by Omron Companies has been checked and is believed to be accurate; however, no responsibility is assumed for clerical, typographical or proofreading errors or omissions.

2016.2

In the interest of product improvement, specifications are subject to change without notice.

OMRON Corporation
Industrial Automation Company

<http://www.ia.omron.com/>

(c)Copyright OMRON Corporation 2016 All Right Reserved.