

# OMRON

## Safety Edge/ Edge Controller

### SGE/SCC

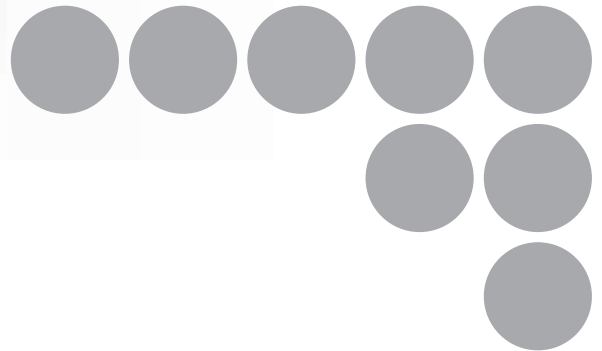

*Introducing the New Safety Edge  
- Friendly to Human and Machines*



realizing

# EDGE

## SAFETY EDGE & EDGE CONTROLLER



SGE  
Safety Edge



SCC  
Edge Controller

### Introducing the New Safety Edge - Friendly to Human and Machines

The SGE Safety Edge, mounted to moving parts such as doors and fences of mechanical equipment, will stop hazards from moving parts or undergo a complete system shutdown upon detection of contact with persons or objects. Its elastic material and shock absorption properties soften the impact on such persons or objects. The SCC Edge Controller conforms to PLe/Safety Category 3. Occurrence of any short-circuits and/or breaks are continually monitored and the status shown with LED indicators.

## APPLICATION Protecting people in such areas like:

### Shutter Door

The Safety Edge mounted to the end of a shutter door stops the downside movement of the shutter to prevent shearing of a person or object when it detects a contact with them.

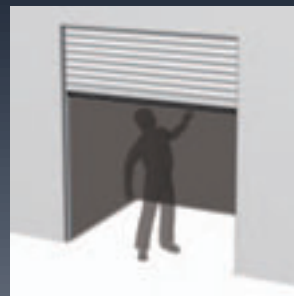

### Protective Door of a Processing Machine

The Safety Edge, mounted to the moving part of a protective door, will stop door movement to prevent jamming of persons or objects upon detection of contact with them.

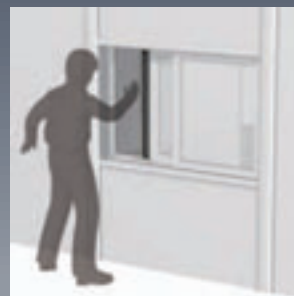

### Reciprocating Table of a Machine Tool

The Safety Edge, mounted to the moving part of a reciprocating table, will stop the table's movement to prevent collision with the moving part or jamming between the moving part and structures such as walls or poles upon detection of contact with workers.



# SAFETY EDGE & EDGE CONTROLLER

## Extensive Lineup

We have prepared a lineup, tailor-made to fit with your devices and applications.

- **Sensor length**  
150 to 6,100 mm  
(in 50 mm increments)
- **Height**  
34 to 80 mm in six series



When using applications that require increased water resistance, please use models that give sealing covers.

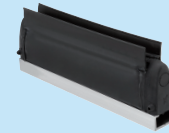

SGE-245L

## Easy to Order & Assembly Free

By covering just 4 points, a ready-to-use Safety Edge will be delivered to you:



### Shape

Select a shape from five series as required in your application or equipment



POINT  
1

POINT  
2

### Wiring

Select wiring from four types (2-wire/connector (male/female) cable, terminating resistor) and cable length 100 mm or any length from 500 mm to 10,000 mm with increments of 500 mm for both ends of the Safety Edge.

### Length

Select any length from 150 mm to 6,100 mm with increments of 50 mm.

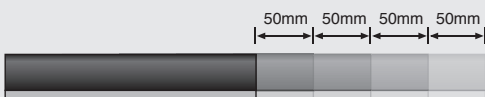

POINT  
3

POINT  
4

### Mounting base

An L-shaped mounting base is also provided depending on the mounting location (except the SGE-125 series)

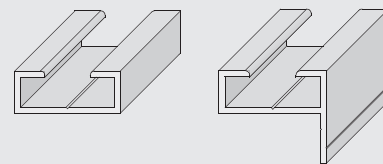

Note: For details, refer to "Model Number Structure" on page 4 or later.

## SCC Edge Controller

Dedicated SCC Edge Controller that regulates a system conforming to Safety Category 3.



- Dedicated SCC Edge Controller enables establishment of a safety system conforming to PLe Safety Category 3 (when hazards are directly blocked by built-in relays)
- Any short-circuits or breaks in the system are monitored and its status is indicated with LED.
- Authenticated under major safety standards

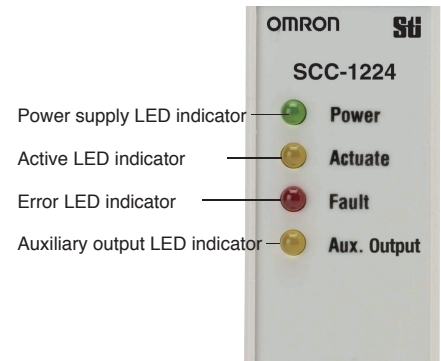

Note: For details on LED indicators, refer to "Connection" on page 13.

# Safety Edge/Edge Controller SGE/SCC

## Safety sensors to detect contacts by mounting to moving parts of hazards



- Conforms to PLe/Safety Category 3 in combination with the dedicated controller.  
(applied when internal relays with forcibly guided contacts disable hazard source directly)
- Simple one-unit structure integrating sensor and cover.
- Resistant to the side force.
- Can be used in various applications.  
Sensor length: 150 mm to 6,100 mm, Height: 34 mm to 80 mm
- Models with sealing covers for doors are provided (SGE-245L).
- Certified standard: EN1760-2 (Safety Edge Standard)



Be sure to read the "Safety Precautions" on page 17.

## Model Number Structure

### Ordering process

SGE series safety edges are custom order products according to customer's equipment or application. Select a product and specifications as shown in the following steps, and contact your OMRON representative.

### Step 1. Models

Select a cross-sectional shape of a safety edge (sensor).  
Select the most appropriate model to the equipment used, considering actuation distance (amount of compression required from an application of pressure to the safety edge to detection), and actuation force (compression force at the actuation distance).  
Five series with different cross-sectional shapes are provided.

Code	125	225	245	245L	365
Model	SGE-125	SGE-225 *2	SGE-245	SGE-245L	SGE-365
Shape					
Actuation distance *1	2.6 mm	3.9 mm	7.4 mm		5.2 mm
Actuation force *1	42 N	57 N	68 N		78 N

\*1. Values of actuation distance and actuation force are characteristic values tested according to EN 1760-2 using a test object of  $\phi 80$  mm and actuating point C3 under a test temperature of 20°C and test speed  $v = 10$  mm/s. Refer to "Characteristics" on page 11 for details.  
\*2. The SGE-225 can be used for finger protection. The actuation force is 20 N when the SGE-225 is used for finger protection.  
(Characteristic values tested according to EN 1760-2 using a test object of  $\phi 20$  mm and actuating point C3 under a test temperature of 20°C and test speed  $v = 10$  mm/s)

**Note:** 1. For the differences in characteristics, refer to "Specifications" on page 9.  
2. Models with sealing cover to reduce liquid splash to the inside and outside of the door are available (SGE-245L). These models can be used in applications where sensors are installed on moving doors of machines.

## Step 2. Wiring Configuration and Cable Termination

Determine a wiring configuration according to the number of safety edges (sensor) in series. (Up to 5 safety edges can be connected in series.) There are five types of cable termination for both ends of the safety edge. The method can be selected from the combinations of 2-wire cable, cable with M8 connector (male or female), and terminating resistor as shown below.

Configuration No.	Outline drawing	Wiring configuration and cable termination
0		2-wire cable on both sides
2		2-wire cable on one side, terminating resistor on the other side (8.2kΩ 0.25W) *
3		Connector cable on one side (male), connector cable on the other side (female)
4		Connector cable on one side (male), terminating resistor on the other side (8.2kΩ 0.25W) *
5		2-wire cable on one side, connector cable on the other side (female)

**Note:** 1. To connect safety edges in series, two types of methods are available : Using a 2-wire cable or M8 connector.

2. To connect with an edge controller, a 2-wire cable should be used. There is no polarity.

\* Use of a terminating resistor is required on one side of the last series-connected safety edge.

### Configuration Example

#### Using one safety edge (Configuration No. 2 x 1)

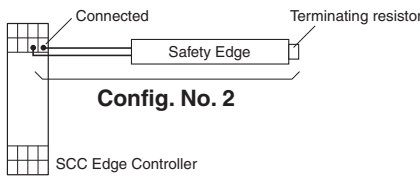

#### Using two safety edges

##### Connecting using 2-wire cables (Config. No. 0 x 1) + (Config. No. 2 x 1)

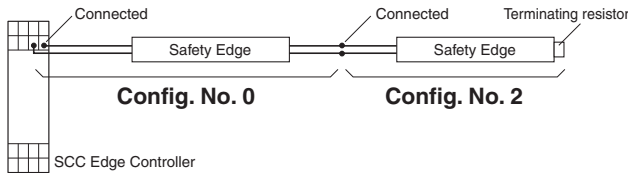

##### Connecting using connectors (Config. No. 5 x 1) + (Config. No. 4 x 1)

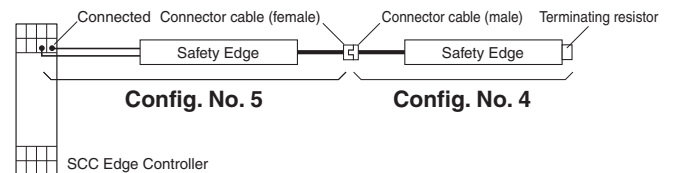

#### Using N safety edges

##### Connecting using 2-wire cables (Config. No. 0 x (N - 1)) + (Config. No. 2 x 1)

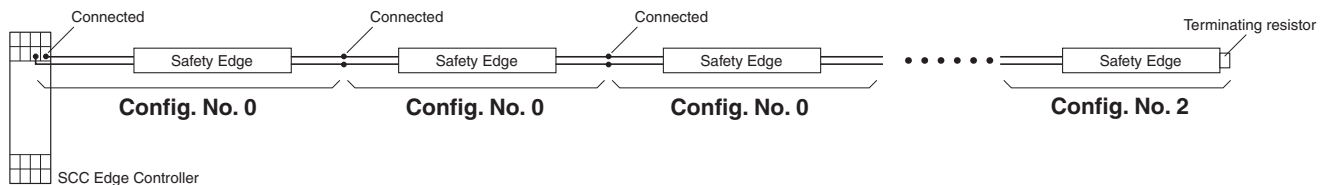

##### Connecting using connectors (Config. No. 5 x 1) + (Config. No. 3 x (N-2)) + (Config. No. 4 x 1)

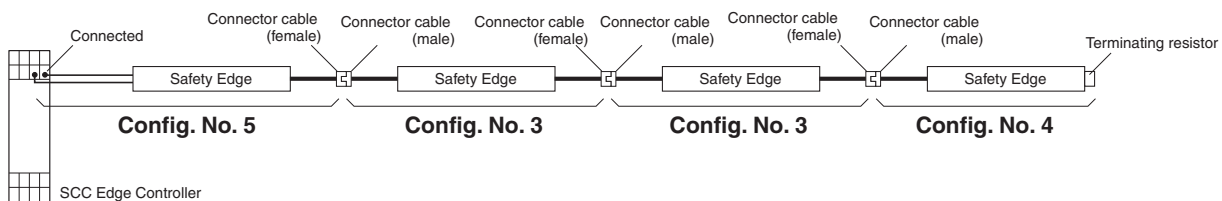

### Step 3. Sensor Length

Determine the length of a safety edge.

Choose any length from **0150** mm\* to **6100** mm with increments of 50 mm.

\* When the length is less than 1,000 mm, zero "0" is added on the top of the number to make it four digits.

- Note:**
1. The user cannot cut the safety edge.
  2. For other lengths, contact your OMRON representative.

### Step 4. Mounting Base

Aluminum base is used to mount a safety edge (sensor) to equipment. Select one from the following.

Model	SGE-125	SGE-225/245		SGE-365	
Code	None	None	L	None	L
Shape					

**Note:** A base with more than 1.2 m is cut and split before delivery as shown below.

Sensor length = LEN (mm)	Mounting base cut length (mm)	No. of split bases
0150 to 1200	LEN	1
1210 to 2400	1/2 LEN	2
2410 to 3600	1/3 LEN	3
3610 to 4800	1/4 LEN	4
4810 to 6000	1/5 LEN	5
6010 to 6100	1/6 LEN	6

(Example) When the sensor length LEN is 2,700 mm, three 900 mm mounting bases will be provided.

### Step 5. Cable Length and Cable Termination

Determine the cable length of both ends of the safety edge.

Choose **00100** mm length or any length from **00500** mm to **10000** mm with increments of 500 mm.

- Note:**
1. For internal terminal resistor side, there is no cable. Cable length is not specified.
  2. Code length is indicated by five digits. Add 00 on the top of the number for 100 mm or more and less than 1,000 mm, add 0 for 1,000 mm or more and less than 10,000 mm.
  3. For other lengths, contact your OMRON representative.

Determine the cable termination method for both ends of a safety edge and add a code at the end of the cable length.

Code	Specification
<b>C</b>	2-wire cable
<b>M</b>	Connector cable (male)
<b>F</b>	Connector cable (female)

**Note:** When using a terminating resistor, cable termination method is not required to be selected.

### Step 6. Direction of Cable Connection

Determine the direction of the cable that is connected to the Safety Edge.

Code	Direction of Cable Connection	
	SGE-125	SGE-225 SGE-245(L) SGE-365
<b>None</b>	The cables are connected to the right side of the Safety Edge. 	The cables are connected to the bottom of the Safety Edge. 
<b>R</b>	—	The cables are connected to the right side of the Safety Edge. 
<b>L</b>	The cables are connected to the left side of the Safety Edge. 	The cables are connected to the left side of the Safety Edge. 

**Note:** Refer to "Model Number Legend" for 5 and 6 in the above table.

Orders can be customized by selecting items from Step 1 to 6. Also see "Model Number Legend" on the following page.

## Model Number Legend

### Safety Edge

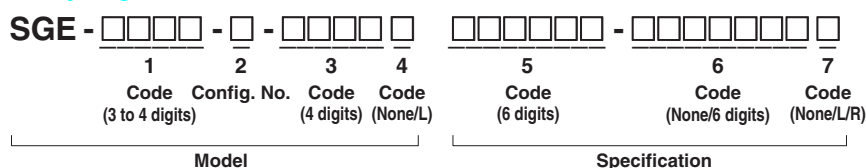

### 1. Type

Code	Cross-section dimensions (including standard mounting base) *
125	15 mm x 34 mm
225	25 mm x 39 mm
245	25 mm x 60 mm
245L	25 mm x 74 mm (including sealing cover)
365	35 mm x 80 mm

\* For dimensions including L-shaped base, refer to "Dimensions/ Terminal Arrangement" on page 14.

### 2. Wiring Configuration and Cable Termination

Configuration No.	Specification
0	2-wire cable on both sides
2	2-wire cable on one side, terminating resistor on the other side
3	Connector cable on one side (male), connector cable on the other side (female)
4	Connector cable on one side (male), terminating resistor on the other side
5	2-wire cable on one side, connector cable on the other side (female)

### 3. Sensor Length

Code	Specification
4-digit number	0150 to 6,100 mm (in increments of 50 mm)

### 4. Mounting Base

Code	Specification
None	Standard Mounting Base
L	L-shaped Mounting Base

Note: Only the Standard Mounting Base is available for the SGE-125.

### 5 and 6. Cable Length and Cable Termination

When the configuration number of "2" is 2 or 4, specify "5" only, when it is 0, 3, or 5, specify "5" and "6" (on account of cable termination on both sides).

Terminal code C: 2-wire cable M: Connector cable (male)  
F: Connector cable (female)

Config. No. of 2	5		6	
	Cable Length * (5 digits)	Terminal code	Cable Length * (5 digits)	Terminal code
0	00100 to 10000	C	00100 to 10000	C
2	00100 to 10000	C	Terminating resistor	None
3	00100 to 10000	M	00100 to 10000	F
4	00100 to 10000	M	Terminating resistor	None
5	00100 to 10000	C	00100 to 10000	F

\* Choose 100 mm length or any length from 500 mm to 10,000 mm with increments of 500 mm.

### 7. Direction of Cable Connection

Code	Direction of Cable Connection	
	SGE-125	Other models
None	Right (standard)	Bottom (standard)
R	–	Right
L	Left	Left

### Edge Controller



### 8. Type

Code	Specification
1224	The auxiliary output is one-shot timer output that turns ON between two and three second after the application of pressure to the safety edge.
1224ND	While pressure is applied to the safety edge, the auxiliary output is kept ON.

## Selection Example 1

SGE-225-2-1500 500C

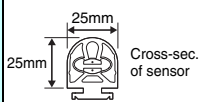
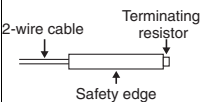
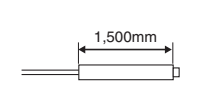
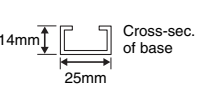
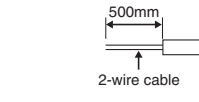
Sequence	Step 1	Step 2	Step 3	Step 4	Step 5
Location					
Category	1. Type	2. Config. No.	3. Sensor Length	4. Mounting Base	5. Cable Length and Cable Termination
Code/Config. No.	225	2	1500	None	00500C

## Selection Example 2

SGE-245-5-0700L 01000C-00500F

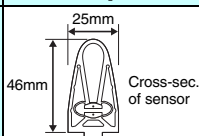
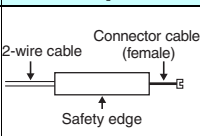
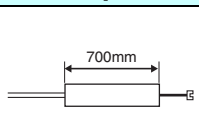
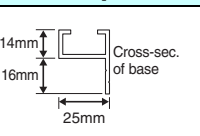
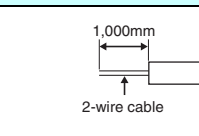
Sequence	Step 1	Step 2	Step 3	Step 4	Step 5
Location					
Category	1. Type	2. Config. No.	3. Sensor Length	4. Mounting Base	5. Cable Length and Cable Termination
Code/Config. No.	245	5	0700	L	01000C 00500F







# SGE/SCC

## Ordering Information

### Edge Controller

Appearance	Safety output	Auxiliary output	Ratings	Terminal	Model
	DPST-NO	SPST-NO (One-shot timer that turns ON between two and three seconds after the application of pressure to the safety edge)	24 VDC	Screw terminals	SCC-1224
		SPST-NO (Kept ON during the application of pressure to the safety edge)			SCC-1224ND

### Safety Edge

Appearance	Cross-sectional dimensions (including a standard mounting base) * 1	Actuation distance * 2	Material	Model	Specification (Cable)
	15 mm x 34 mm	2.6 mm	TPE	SGE-125-□-□	□ (-□)
	25 mm x 39 mm	3.9 mm	EPDM	SGE-225-□-□ (L)	□ (-□)
	25 mm x 60 mm	7.4 mm		SGE-245-□-□ (L)	□ (-□)
	25 mm x 60 mm 25 mm x 74 mm (including sealing cover)			SGE-245L-□-□ (L)	□ (-□)
	35 mm x 80 mm	5.2 mm		SGE-365-□-□ (L)	□ (-□)

\*1. For dimensions including L-shaped base, refer to "Dimensions/Terminal Arrangement" on page 14.

\*2. Values of actuation distance are characteristic values tested according to EN 1760-2 using a test object of  $\phi 80$  mm and actuating point C3 under a test temperature of 20°C and test speed  $v = 10$  mm/s. Refer to "Characteristics" on page 11 for details.



# Specifications

## Edge Controller

Item	Model	SCC-1224 SCC-1224ND
Safety edge inputs		Up to five series connections on the safety edges
Response time		13 ms max.
Power supply voltage		115 VAC $\pm$ 5%, 3.3 VA or 24 VDC $\pm$ 10%, 1.5 VA
Safety output		DPST-NO (Rated resistive load: 250 VAC/30 VDC 4A)
Auxiliary output		SPST-NO SCC-1224: One-shot timer that turns ON between two and three seconds after the application of pressure to the safety edge SCC-1224ND: Kept ON during the application of pressure to the safety edge (Rated resistive load: 250 VAC, 2.5 A/30 VDC, 2.5 A)
Terminating resistor		8.2 k $\Omega$
Ambient operating temperature		-20 to 50°C (With no icing or condensation)
Degree of protection		IP20
Terminal type		Screw terminals
Terminal tightening torque		0.5 to 0.6 N·m
Mounting method		DIN rail mounted
Weight (factory-set)		210 g

## Safety Edge

Item	Model	SGE-125	SGE-225 *4	SGE-245 SGE-245L	SGE-365
Material *1		TPE	EPDM		
Material hardness		65 Shore A	68 Shore A		
Max. length of a single safety edge		6.1 m			
Actuation distance *2		2.6 mm	3.9 mm	7.4 mm	5.2 mm
Actuation force *2		42 N	57 N	68 N	78 N
Maximum allowable load		500N			
Overtravel distance *2 (400 N)		9.5 mm	6.7 mm	18.3 mm	33.8 mm
Maximum operation angle		2 x 30°		2 x 45°	
Inactive end region *3		20 mm	40 mm	20 mm	
Connecting cable		2 conductors, 0.34 mm <sup>2</sup> , Allowable bending radius: R38mm Cable Specifications Type : PUR (Polyurethane) Round lead cable External diameter : 3.5 dia. Number of conductors : 2 conductors Cross-section of conducto : 0.34 mm <sup>2</sup> Insulator diameter : 1.2 dia.			
Mechanical durability		10,000 operations min.			
Ambient temperature		During operation: -10 to 55°C (with no icing), During storage: -25 to 75°C (with no icing)			
Operating ambient humidity		0 to 90%RH			
Degree of protection		IP65			
Unit weight		0.18 kg/m	0.51 kg/m	0.77 kg/m (SGE-245) 0.82 kg/m (SGE-245L)	1.10 kg/m

\*1. TPE: Thermoplastic Elastomer  
EPDM: Ethylene Propylene Rubber

\*2. Values of actuation distance and actuation force are characteristic values tested according to EN 1760-2 using a test object of  $\phi$ 80 mm and actuating point C3 under a test temperature of 20°C and test speed  $v = 10$  mm/s. Refer to "Characteristics" on page 11 for details.

\*3. There is an inactive region (including an end cap) in both ends of the safety edge.

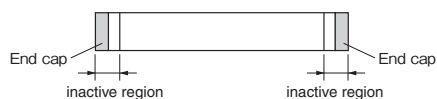

\*4. The SGE-225 can be used for finger protection. The actuation force is 20 N when the SGE-225 is used for finger protection. (Characteristic values tested according to EN 1760-2 using a test object of  $\phi$ 20 mm and actuating point C3 under a test temperature of 20°C and test speed  $v = 10$  mm/s)

**Mechanical Force**

Material	TPE						EPDM						
	Model	SGE-125						SGE-225, SGE-245, SGE-365					
		1	2	3	4	5	6	1	2	3	4	5	6
<b>Features Strength #</b>													
<b>Tear Strength (Resistance)</b>			3						3				
<b>Ultimate Tensile Strength</b>			3						3				
<b>Rebound Elasticity at 20°C</b>		2						2					
<b>Resistance Against Permanent Deformation</b>			3	4				2					
<b>Abrasion</b>			3						3				
<b>Elongation at Tear</b>				4	5				3				
<b>Cold Flexibility</b>		2						2					

**Note:** 1 = Excellent  
 2 = Very good  
 3 = Good  
 4 = Fair  
 5 = Poor  
 6 = Very poor

**Environmental Resistance**

Material	TPE						EPDM						
	Model	SGE-125						SGE-225, SGE-245, SGE-365					
		1	2	3	4	5	6	1	2	3	4	5	6
<b>Heat Stability</b>				4				2					
<b>Oxidation Stability</b>	1						1						
<b>UV Stability</b>	1						1						
<b>Weather/Ozone Resistance</b>	1						1						
<b>Flame Resistance</b>						6						6	
<b>Gas Permeability</b>			3							4			

**Note:** 1 = Excellent  
 2 = Very good  
 3 = Good  
 4 = Fair  
 5 = Poor  
 6 = Very poor

**Chemical Resistance**

Material	TPE						EPDM						
	Model	SGE-125						SGE-225, SGE-245, SGE-365					
		1	2	3	4	5	6	1	2	3	4	5	6
<b>Features Effects #</b>													
<b>Water Resistance</b>	1						1	2					
<b>Diluted Acids</b>	1							2					
<b>Diluted Bases</b>	1							2					
<b>Non-Oxidizing Acids</b>		2						2					
<b>Oxidizing Acids</b>		2								4			
<b>ASTM Oil #3</b>		2										6	
<b>Vegetable Oils</b>	1	2									5		
<b>Organic Solvents</b>								2					
<b>Ester Solvents</b>		2	3					2					
<b>Ketone Solvents (Containing Oxygen)</b>		2	3						3				
<b>Aliphatic Hydrocarbons Solvents (Gasoline)</b>											5		
<b>Aromatic Hydrocarbons</b>												6	
<b>Hydrocarbons</b>		2	3								5	6	
<b>Alcohol</b>	1						1						

**Note:** 1 = No Effects, Permanent Contact  
 2 = Few Effects, Some Contact  
 3 = Medium Effects, Some Contact  
 4 = Noticeable Effects, Reduced Contact  
 5 = Severe Effects, Very Brief Contact  
 6 = Extreme Effects, Avoid Contact

# Characteristics

## Force Distance

SGE-225: Characteristic Values for Test Speed  $v = 10 \text{ mm/s}$   
 Test Temperature  $+20^\circ\text{C}$

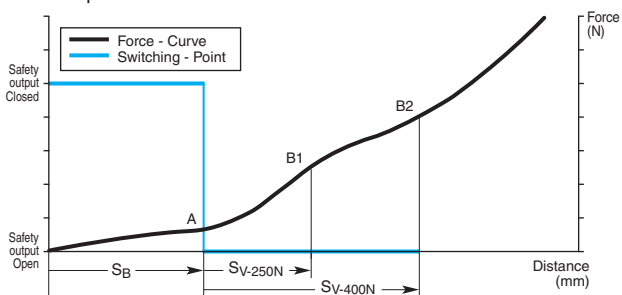

### SGE-125: Characteristic Values for Test Speed $v = 10 \text{ mm/s}$

Test Temperature	$+20^\circ\text{C}$
Actuating Force $F_A$ (N)	42
Actuating Distance $S_B$ (mm)	2.6
Overtravel Distance $S_v$ at 250N in mm	8.1
Overtravel Distance $S_v$ at 400N in mm	9.5

Note: Tested according to EN 1760-2, test object of  $\varnothing 80\text{mm}$ , actuating point C3.

### SGE-225: Characteristic Values for Test Speed $v = 10 \text{ mm/s}$

Test Temperature	$+20^\circ\text{C}$
Actuating Force $F_A$ (N)	57
Actuating Distance $S_B$ (mm)	3.9
Overtravel Distance $S_v$ at 250N in mm	2.3
Overtravel Distance $S_v$ at 400N in mm	6.7

Note: Tested according to EN 1760-2, test object of  $\varnothing 80\text{mm}$ , actuating point C3.

### SGE-245: Characteristic Values for Test Speed $v = 10 \text{ mm/s}$

Test Temperature	$+20^\circ\text{C}$
Actuating Force $F_A$ (N)	68
Actuating Distance $S_B$ (mm)	7.4
Overtravel Distance $S_v$ at 250N in mm	15.8
Overtravel Distance $S_v$ at 400N in mm	18.3

Note: Tested according to EN 1760-2, test object of  $\varnothing 80\text{mm}$ , actuating point C3.

### SGE-365: Characteristic Values for Test Speed $v = 10 \text{ mm/s}$

Test Temperature	$+20^\circ\text{C}$
Actuating Force $F_A$ (N)	78
Actuating Distance $S_B$ (mm)	5.2
Overtravel Distance $S_v$ at 250N in mm	29.8
Overtravel Distance $S_v$ at 400N in mm	33.8

Note: Tested according to EN 1760-2, test object of  $\varnothing 80\text{mm}$ , actuating point C3.

### SGE-125: Characteristic Values for Test Speed $v = 100 \text{ mm/s}$

Test Temperature	$+20^\circ\text{C}$
Actuating Force $F_A$ (N)	43
Actuating Distance $S_B$ (mm)	6.4
Overtravel Distance $S_v$ at 250N in mm	7.7
Overtravel Distance $S_v$ at 400N in mm	8.6

Note: Tested according to EN 1760-2, test object of  $\varnothing 80\text{mm}$ , actuating point C3.

### SGE-225: Characteristic Values for Test Speed $v = 100 \text{ mm/s}$

Test Temperature	$+20^\circ\text{C}$
Actuating Force $F_A$ (N)	63
Actuating Distance $S_B$ (mm)	4.4
Overtravel Distance $S_v$ at 250N in mm	2.7
Overtravel Distance $S_v$ at 400N in mm	7.2

Note: Tested according to EN 1760-2, test object of  $\varnothing 80\text{mm}$ , actuating point C3.

### SGE-245: Characteristic Values for Test Speed $v = 100 \text{ mm/s}$

Test Temperature	$+20^\circ\text{C}$
Actuating Force $F_A$ (N)	83
Actuating Distance $S_B$ (mm)	7.8
Overtravel Distance $S_v$ at 250N in mm	15.2
Overtravel Distance $S_v$ at 400N in mm	17.7

Note: Tested according to EN 1760-2, test object of  $\varnothing 80\text{mm}$ , actuating point C3.

### SGE-365: Characteristic Values for Test Speed $v = 100 \text{ mm/s}$

Test Temperature	$+20^\circ\text{C}$
Actuating Force $F_A$ (N)	107
Actuating Distance $S_B$ (mm)	6.2
Overtravel Distance $S_v$ at 250N in mm	28.3
Overtravel Distance $S_v$ at 400N in mm	32.7

Note: Tested according to EN 1760-2, test object of  $\varnothing 80\text{mm}$ , actuating point C3.

## Installation

Safety edges must only be installed by authorized persons.

1. To facilitate installation of the safety edge, the mounting base may only be attached to even surfaces. If the safety edge is mounted in a bend, the radius must not be less than the specified minimum.

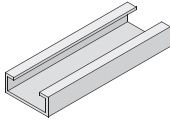

2. The mounting base must be fitted with countersunk screws or rivets. A diameter of 4 mm is sufficient. The holes of 4.5 mm must be evenly distributed over the entire length of the mounting base with distances between them not exceeding 300 mm. They have to be countersunk according to the screw size.

For SGE-225/245 (L-shaped)  
For SGE-365 (L-shaped)

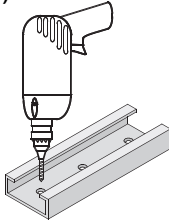

When using SGE-125, drill a pilot hole to the groove such that the head of a countersunk screw can go through (approx. 8 mm).

For SGE-125

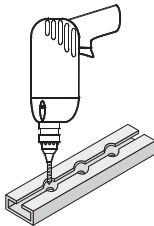

3. Pan- or round-head screws should not be used. Otherwise the connecting wire in the mounting base could be damaged.



4. In order to lead the connecting wire through the mounting base, an 8 mm hole has to be drilled in the appropriate place. Carefully remove the burr from both sides.

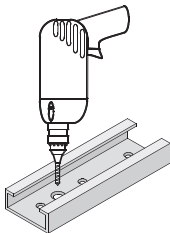

5. The connecting wire and the cable end with the terminal resistor have to be placed in the mounting base.

6. In order to make fitting the safety edge easier, the mounting base and the safety edge should be sprayed with soapy water. Once the soap suds have evaporated, the safety edge is firmly fitted in the aluminum base. To prevent a subsequent slipping of the safety edge, talcum powder, oils or similarly durable lubricants must not be used.

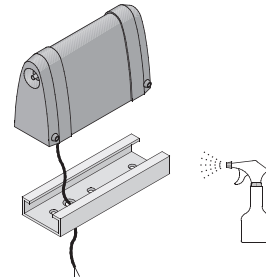

7. Safety edges with a C-base (SGE-365) have to be clipped with one side into the mounting base. Then press in the complete c-base. Pulling or pushing the safety edge into the mounting base can cause damage to the safety edge and should be avoided at all costs.

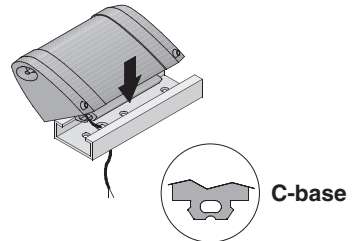

8. Safety edges with T-bases (SGE-125/-225/-245/-245L) have to be inserted from the side along the groove of the mounting base.

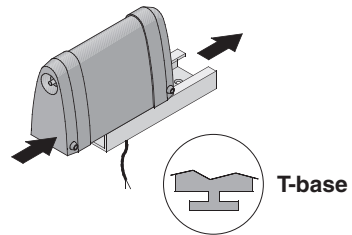

Any other methods of fastenings are only permitted on prior agreement with the manufacturer.

# Connections

## Internal Connection Diagram

SCC-1224  
SCC-1224ND

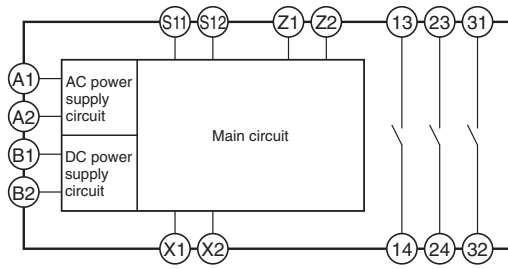

## Wiring for input/output

SCC-1224  
SCC-1224ND

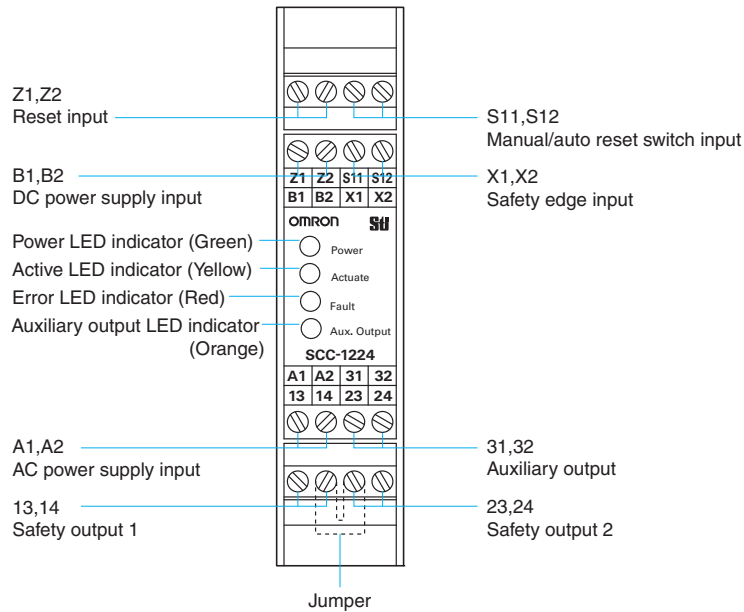

**Note:** A jumper is set between terminal 14 and 23 in the default settings.  
Remove the jumper if safety output 1 and 2 are not connected in series.

## Terminals

Signal name	Terminal name	Operation	Wiring
Safety edge input	X1, X2	Connect to SGE Safety Edge.	Connect a 2-wire cable to SGE Safety Edge. There is no polarity.
Manual/ auto reset switch input	S11, S12	Switch between auto reset and manual reset.	<ul style="list-style-type: none"> <li>For auto reset, open the terminal between S11 and S12 (Default setting)</li> <li>For manual reset, short-circuit the terminal between S11 and S12.</li> </ul>
DC power supply input	B1, B2	Power supply input terminals to be used with DC power supply.	Open when using them with AC power supply.
Reset input	Z1, Z2	Input terminals for reset switch (NO contact) Connect to pushbutton switch or key switch.	They do not need to be connected for auto reset mode.
AC power supply input	A1, A2	Power supply input terminals to be used with AC power supply.	Open when using them with DC power supply.
Auxiliary output	31-32	<ul style="list-style-type: none"> <li>SCC-1224 Operates as one-shot delay timer that closes contacts after power is turned ON or when the SGE safety edge operates, and open after 2 seconds or less than 3 seconds.</li> <li>SCC-1224ND Contacts close when the SGE safety edge operates, and keeps closed until the safety edge returns to its normal operation.</li> </ul>	Open when not used. Do not use this contact for safety circuits.
Safety output 1	13-14	Turn the output ON or OFF according to safety edge inputs and reset inputs.	Open when not used. A jumper is set between terminal 14 and 23 in the default settings. Remove the jumper if safety output 1 and 2 are not connected in series.
Safety output 2	23-24		

## LEDs

Name	Description
Power supply LED indicator (Green)	Lights when the power supply is ON.
Active LED indicator (Yellow)	Lights when pressure is applied to the SGE safety edge, blinks during interlock state. When pressure is released, the interlock is reset and turned OFF.
Error LED indicator (Red)	Lights when a wiring error of the safety edge occurs such as cable disconnection of the SGE safety edge, contact failure of terminal X1 and X2 of the SCC edge controller, or when a terminating resistor is not connected to the safety edge.
Auxiliary output LED indicator (Orange)	Lights when pressure is applied to the SGE safety edge, and blinks when an auxiliary output contact is closed (auxiliary output ON) SCC-1224: Lights OFF after 2 seconds or more/less than 3 seconds. SCC-1224ND: Keeps ON while pressure is applied to the SGE safety edge.

# SGE/SCC

## Dimensions/Terminal Arrangement

(Unit: mm)

Edge Controller  
 SCC-1224  
 SCC-1224ND

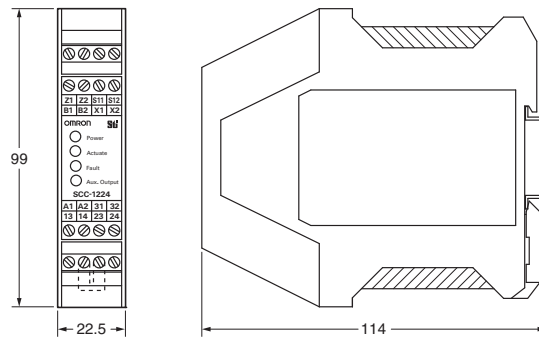

### Terminal Arrangement

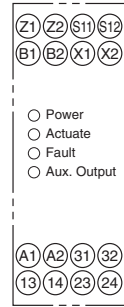

### Safety Edge

SGE-125

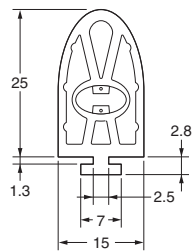

SGE-225

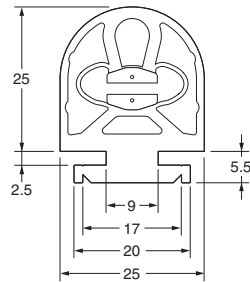

SGE-245

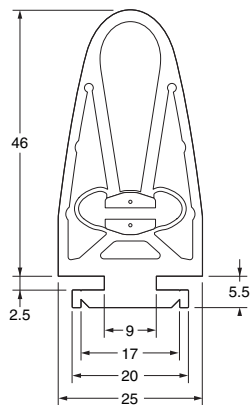

SGE-245L

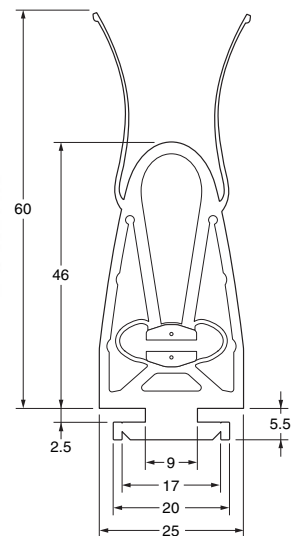

SGE-365

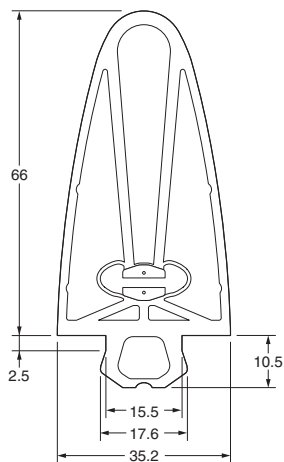

Mounting Bases

For SGE-125

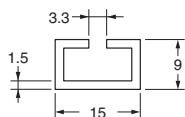
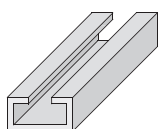

For SGE-225/245

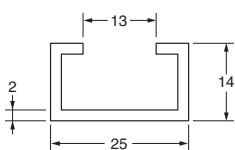
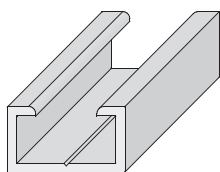

For SGE-225/245 L-shaped

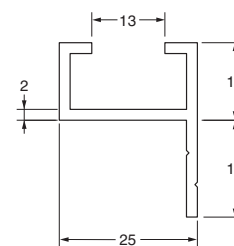
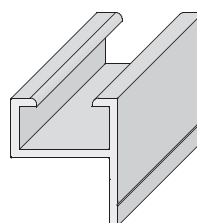

For SGE-365

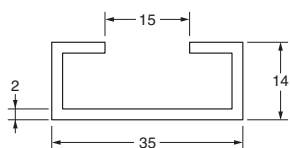
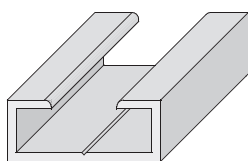

For SGE-365 L-shaped

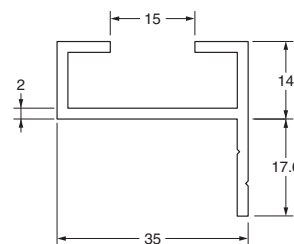
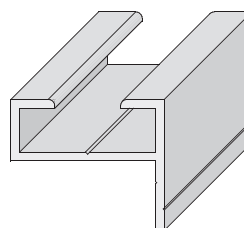

Connectors

Connector (male) Terminal code: M

Pin arrangement

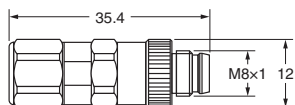

Connector (female) Terminal code: F

Pin arrangement

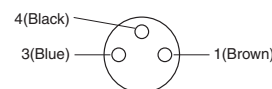



# Application Examples

PL/safety category	Model	Stop category	Reset
PLe/3 equivalent	Safety Edge/Edge Controller SGE+SCC Safety Door Switch D4GS-N/D4NS/D4BS Safety Relay Unit G9SB	0	Manual/Auto

(A Safety Relay Unit or Safety Controller other than the G9SB can be used.)

**Note:** The above PL is only the evaluation result of the example. The PL must be evaluated in an actual application by the customer after confirming the usage conditions.

## Application Overview

- The power supply to the motor M is turned OFF when pressure is applied to the edge.
- The power supply to the motor M is turned OFF when the S2 detects that the guard is opened.
- The power supply to the motor M is kept OFF until pressure is not applied to the edge (, the reset switch S1 is pressed for manual reset) and the guard is closed.

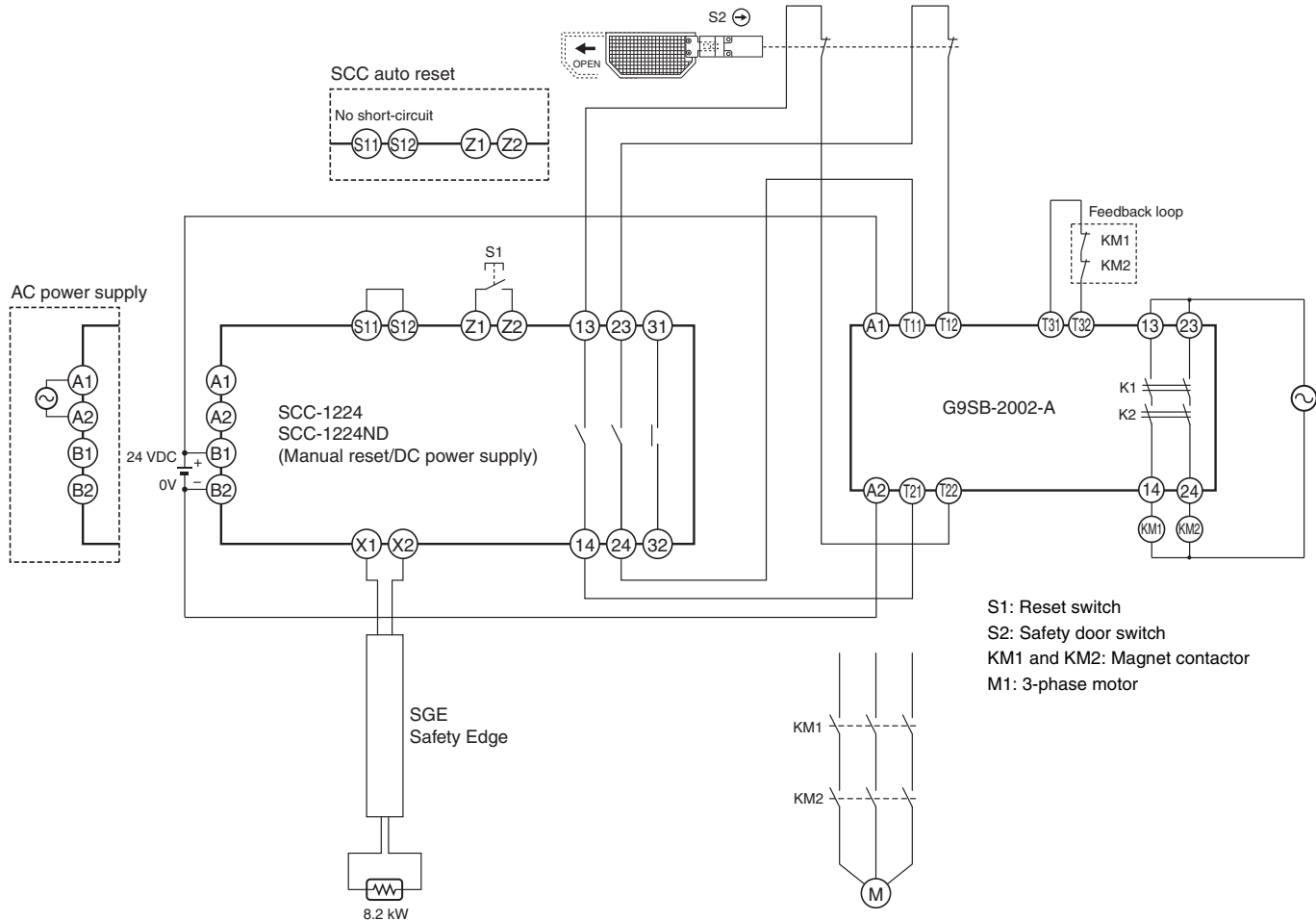

**Note 1:** This figure shows the SGE Safety Edge with no pressure on it and the S1 reset switch before it is pressed.  
**2:** There is no polarity for X1 and X2.

### Timing Chart (SCC Auto Reset)

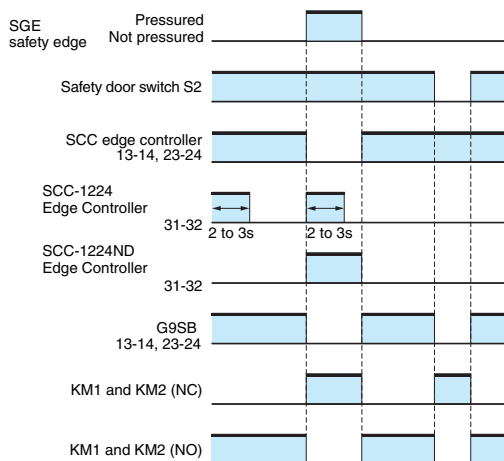

### Timing Chart (SCC Manual Reset)

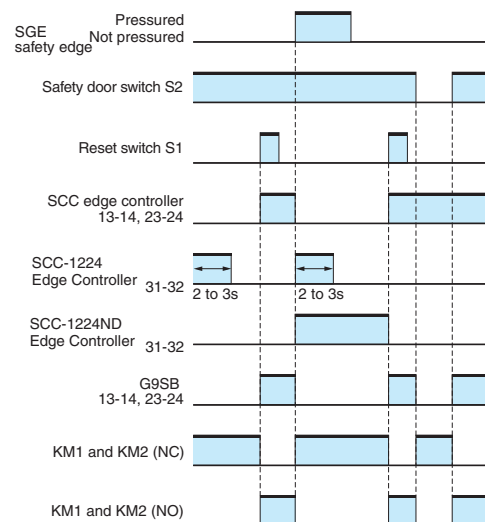

## Safety Precautions

### WARNING

Always verify the operation of the safety functions before starting the system. Not doing so may result in the safety functions not performing as expected if the wiring or settings are incorrect or the switches have failed.



Do not drop the switch. Doing so may damage the switch and the system may continue to operate, possibly causing injury or death.



### WARNING

#### Edge Controller

Serious injury may possibly occur due to breakdown of safety outputs.

Do not connect loads beyond the rated value to the safety outputs.



Serious injury may possibly occur due to loss of required safety functions.

Serious injury may occur due to loss of required safety functions. Do not use the Safety Edge with logics that the operation of the mat might turn ON the guarded equipment. Use the Safety Edge with logics by which safety outputs turn OFF in a hazardous state.



Serious injury may possibly occur due to loss of required safety functions.

Wire the Edge Controller properly so that supply voltages or voltages for loads do NOT touch the safety outputs accidentally.



#### Safety Edge

Serious injury may possibly occur due to loss of required safety functions.

When using a safety edge, design a safety system counting the velocity and weight of detecting objects.



### Precautions for Safe Use

#### Edge Controller

- (1) Be sure to turn OFF the power before performing wiring. Do not touch any of the terminals while the power is being supplied. Doing so may result in electric shock.
- (2) Do not perform wiring when there is a risk of lightning. Doing so may result in electric shock.
- (3) Apply the specified voltage to input terminals. Applying a different voltage may prevent proper operation and may result in product damage or burning.
- (4) Use a power supply of the specified voltage. Do not use power supplies with large ripples or power supplies that intermittently generate incorrect voltages.
- (5) Do not under any circumstances, use the product for loads that exceed the product's contact ratings, such as the switching capacity (switching voltage and switching current.) During so may not only result in faulty insulation, contact deposition, contact failure, or other problems affecting product performance, it may also result in damage or burning.
- (6) Relay durability depends greatly on the switching conditions. Confirm operation under the actual conditions in which the Relay will be used. Make sure the number of switching operations is within the permissible range. If a Relay is used after performance has deteriorated, it may result in insulation failure between circuits and burning of the Relay itself.
- (7) Do not use the product in locations subject to explosive or flammable gases. Doing so may cause combustion or explosion due to Relay heating or arcing during switching.
- (8) Do not drop the product or use components that have been disassembled. Doing so may not only adversely affect performance characteristics, it may also result in damage.
- (9) Connect a fuse to the Switch in series to protect the Switch from short-circuit damage or ground faults. Not doing so may result in damage.

#### Safety Edge

- (1) Be sure to turn OFF the power before performing wiring. Doing so may result in electric shock.
- (2) Do not perform wiring when there is a risk of lightning. Doing so may result in electric shock.
- (3) Do not use the product in locations subject to explosive or flammable gases. Doing so may cause combustion or explosion due to Relay heating or arcing during switching.
- (4) Do not drop the product or use components that have been disassembled. Doing so may not only adversely affect performance characteristics, it may also result in damage.

**Precautions for Correct Use**

**Edge Controller**

- (1) Handle with care
  - Do not drop the product or expose it to excessive vibration or mechanical shock. The product may be damaged and may not function properly.
- (2) Adhesion of solvent
  - Do not allow organic solvents, such as alcohol, thinner, trichloroethane, or gasoline, to come into contact with the product. Such solvents make the markings on the Edge Controller illegible and cause deterioration of parts.
- (3) Storage and operating conditions
  - Do not store or use the products under the following conditions.
    - 1. In direct sunlight
    - 2. At ambient temperatures not between -20 and 55°C
    - 3. At relative humidity not exceeding 90% or under temperature changes that could causes condensation
    - 4. At air pressure out of the range of 86 to 106 kPa
    - 5. In corrosive or combustible gases
    - 6. Where subject to vibration or mechanical shock beyond the rated values
    - 7. Where subject to contact with water, oil, or chemicals
    - 8. In an atmosphere containing excessive dust, saline, or metal powder
- (4) Wiring
  - 1. Use the following to wire to the Edge Controller.
    - Stranded wire (Flexible wire): 0.75 to 1.5 mm<sup>2</sup>
    - Solid wire: 0.75 to 1.5 mm<sup>2</sup>
    - Strip the cover of wire no longer than 7 mm.
    - Terminal tightening torque: 0.5 to 0.6 N·m
  - 2. Ground the negative side of the power supply. A controller with the positive side grounding will not work.
- (5) Mounting of multiple Edge Controllers
  - Place the safety edges farther than 25 mm from the nearest SCC.
- (6) Mounting of the Edge Controller to DIN rails
  - Use end plates (PFP-M: sold separately) on both ends of SCC.

- (7) This is a Class A product (Product in industrial setting). Use of the product in residential setting may cause radio disturbance. In such case, take appropriate measures.

**Safety Edge**

- (1) Make sure to use the Safety Edge SGE series in combination with the Edge Controller SCC series or Safety controller G9SP series.
- (2) Handle with care
  - 1. Do not drop the product or expose it to excessive vibration or mechanical shock. The product may be damaged and may not function properly.
  - 2. Do not apply loads on a certain location of the Safety Edge for a long period of time. It may damage the Safety Edge.
  - 3. Do not use the Safety Edge submerged in water or in locations continuously subject to splashes of water.
- (3) Adhesion of solvent
  - Do not allow organic solvents, such as alcohol, thinner, trichloroethane, or gasoline, to come into contact with the product. Such solvents make the markings on the Edge Controller illegible and cause deterioration of parts.
- (4) Storage and operating conditions
  - Do not store or use the products under the following conditions.
    - 1. In direct sunlight
    - 2. At ambient temperatures not between -25 and 75°C
    - 3. At air pressure out of the range of 86 to 106 kPa
    - 4. In corrosive or combustible gases
    - 5. Where subject to vibration or mechanical shock beyond the rated values
    - 6. Where subject to contact with water, oil, or chemicals
    - 7. In an atmosphere containing excessive dust, saline, or metal powder
- (5) Mounting of the Safety Edge
  - 1. Use dedicated mounting brackets to install the Safety Edge.
  - 2. Do not install the Safety Edge on an environment with a projection. Install it on a flat surface.
  - 3. Do not pull the cables to lift or move the Safety Edge.
  - 4. Do not use the Safety Edge with a cover on it.
- (6) This is a Class A product (Product in industrial setting). Use of the product in residential setting may cause radio disturbance. In such case, take appropriate measures.

**Safety Category**

The Safety Edge is certified for PLe and Safety Category 3 when used with an SCC-series Edge Controller. The Safety Edge is certified for PLd and Safety Category 3 when used with a G9SP-series Safety Controller.

To implement a Safety Category 3 and PLd safety circuit with an external safety relay or magnet contactor connected, a safety controller is required separately when using the Safety Edge with an SCC-series Edge Controller.

**Standards**

- SGE-□
  - EN1760-2
  - EN ISO13849-1
- SCC-□
  - EN ISO13849-1 PLe/Safety Category 3

## **READ AND UNDERSTAND THIS CATALOG**

Please read and understand this catalog before purchasing the products. Please consult your OMRON representative if you have any questions or comments.

## **Warranty and Limitations of Liability**

### **WARRANTY**

OMRON's exclusive warranty is that the products are free from defects in materials and workmanship for a period of one year (or other period if specified) from date of sale by OMRON.

OMRON MAKES NO WARRANTY OR REPRESENTATION, EXPRESS OR IMPLIED, REGARDING NON-INFRINGEMENT, MERCHANTABILITY, OR FITNESS FOR PARTICULAR PURPOSE OF THE PRODUCTS. ANY BUYER OR USER ACKNOWLEDGES THAT THE BUYER OR USER ALONE HAS DETERMINED THAT THE PRODUCTS WILL SUITABLY MEET THE REQUIREMENTS OF THEIR INTENDED USE. OMRON DISCLAIMS ALL OTHER WARRANTIES, EXPRESS OR IMPLIED.

### **LIMITATIONS OF LIABILITY**

OMRON SHALL NOT BE RESPONSIBLE FOR SPECIAL, INDIRECT, OR CONSEQUENTIAL DAMAGES, LOSS OF PROFITS OR COMMERCIAL LOSS IN ANY WAY CONNECTED WITH THE PRODUCTS, WHETHER SUCH CLAIM IS BASED ON CONTRACT, WARRANTY, NEGLIGENCE, OR STRICT LIABILITY.

In no event shall responsibility of OMRON for any act exceed the individual price of the product on which liability is asserted.

IN NO EVENT SHALL OMRON BE RESPONSIBLE FOR WARRANTY, REPAIR, OR OTHER CLAIMS REGARDING THE PRODUCTS UNLESS OMRON'S ANALYSIS CONFIRMS THAT THE PRODUCTS WERE PROPERLY HANDLED, STORED, INSTALLED, AND MAINTAINED AND NOT SUBJECT TO CONTAMINATION, ABUSE, MISUSE, OR INAPPROPRIATE MODIFICATION OR REPAIR.

## **Application Considerations**

### **SUITABILITY FOR USE**

OMRON shall not be responsible for conformity with any standards, codes, or regulations that apply to the combination of products in the customer's application or use of the product.

At the customer's request, OMRON will provide applicable third party certification documents identifying ratings and limitations of use that apply to the products. This information by itself is not sufficient for a complete determination of the suitability of the products in combination with the end product, machine, system, or other application or use.

The following are some examples of applications for which particular attention must be given. This is not intended to be an exhaustive list of all possible uses of the products, nor is it intended to imply that the uses listed may be suitable for the products:

- Outdoor use, uses involving potential chemical contamination or electrical interference, or conditions or uses not described in this document.
- Nuclear energy control systems, combustion systems, railroad systems, aviation systems, medical equipment, amusement machines, vehicles, safety equipment, and installations subject to separate industry or government regulations.
- Systems, machines, and equipment that could present a risk to life or property.

Please know and observe all prohibitions of use applicable to the products.

NEVER USE THE PRODUCTS FOR AN APPLICATION INVOLVING SERIOUS RISK TO LIFE OR PROPERTY WITHOUT ENSURING THAT THE SYSTEM AS A WHOLE HAS BEEN DESIGNED TO ADDRESS THE RISKS, AND THAT THE OMRON PRODUCT IS PROPERLY RATED AND INSTALLED FOR THE INTENDED USE WITHIN THE OVERALL EQUIPMENT OR SYSTEM.

## **Disclaimers**

### **CHANGE IN SPECIFICATIONS**

Product specifications and accessories may be changed at any time based on improvements and other reasons.

It is our practice to change model numbers when published ratings or features are changed, or when significant construction changes are made. However, some specifications of the product may be changed without any notice. When in doubt, special model numbers may be assigned to fix or establish key specifications for your application on your request. Please consult with your OMRON representative at any time to confirm actual specifications of purchased products.

### **DIMENSIONS AND WEIGHTS**

Dimensions and weights are nominal and are not to be used for manufacturing purposes, even when tolerances are shown.

### **ERRORS AND OMISSIONS**

The information in this document has been carefully checked and is believed to be accurate; however, no responsibility is assumed for clerical, typographical, or proofreading errors, or omissions.

### **PERFORMANCE DATA**

Performance data given in this catalog is provided as a guide for the user in determining suitability and does not constitute a warranty. It may represent the result of OMRON's test conditions, and the users must correlate it to actual application requirements. Actual performance is subject to the OMRON Warranty and Limitations of Liability.

### **PROGRAMMABLE PRODUCTS**

OMRON shall not be responsible for the user's programming of a programmable product, or any consequence thereof.

## **Copyright and Copy Permission**

### **COPYRIGHT AND COPY PERMISSION**

This document shall not be copied for sales or promotions without permission.

This document is protected by copyright and is intended solely for use in conjunction with the product. Please notify us before copying or reproducing this document in any manner, for any other purpose. If copying or transmitting this document to another, please copy or transmit it in its entirety.

**OMRON Corporation** Industrial Automation Company  
Kyoto, JAPAN

Contact: [www.ia.omron.com](http://www.ia.omron.com)

**Regional Headquarters**

**OMRON EUROPE B.V.**  
Wegalaan 67-69, 2132 JD Hoofddorp  
The Netherlands  
Tel: (31)2356-81-300/Fax: (31)2356-81-388

**OMRON SCIENTIFIC TECHNOLOGIES INC.**  
6550 Dumbarton Circle Fremont  
CA 94555 U.S.A.  
Tel: (1) 510-608-3400/Fax: (1) 510-744-1442

**OMRON ASIA PACIFIC PTE. LTD.**  
No. 438A Alexandra Road # 05-05/08 (Lobby 2),  
Alexandra Technopark,  
Singapore 119967  
Tel: (65) 6835-3011/Fax: (65) 6835-2711

**OMRON (CHINA) CO., LTD.**  
Room 2211, Bank of China Tower,  
200 Yin Cheng Zhong Road,  
PuDong New Area, Shanghai, 200120, China  
Tel: (86) 21-5037-2222/Fax: (86) 21-5037-2200

Authorized Distributor:

© OMRON Corporation 2009-2017 All Rights Reserved.  
In the interest of product improvement,  
specifications are subject to change without notice.

**CSM\_8\_3\_0417**  
**Cat. No. F088-E1-05**

Printed in Japan  
0417 (1109)