

Robotics packaging line solution

Bringing innovation to manufacturing sites

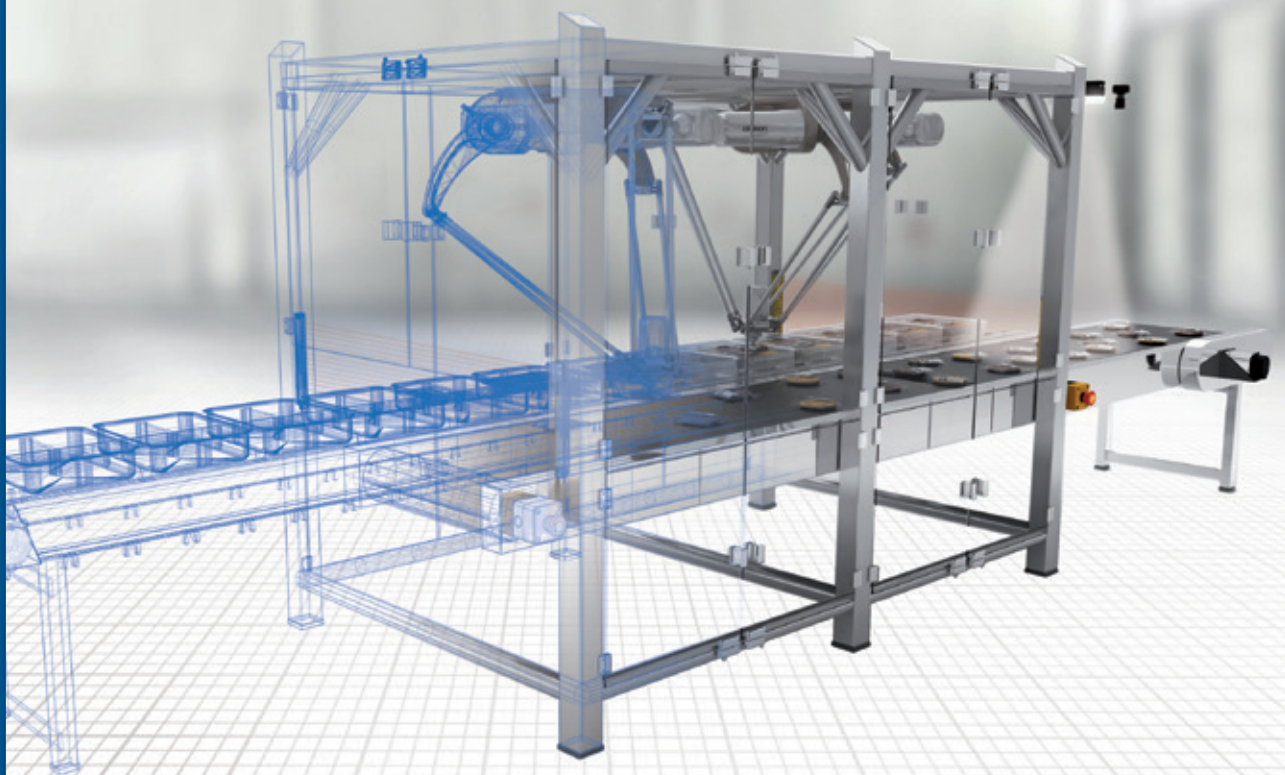

- Flexible robotic solution
- Seamless integration of Virtual and Real
- Global robotic service

Intuitive robotics add flexibility to packaging

The future of intuitive robotics and configurable-modular packaging line

Omron offers a complete solution to automating packaging line helping our customers reach high demanding production. Embedded robots and robotic modules are integrated into packaging machines to increase productivity.

Flexible line: Production line using Omron Adept Technologies Inc. robots

Omron's unique combination of control and robotics technologies for advanced production lines



Parallel Robot Hornet



Parallel Robot Quattro



Table/Floor type SCARA Robot eCobra 600/800



Inverted SCARA Robot eCobra 800 Inverted



Articulated Robot Viper



Mobile Robot LD

Flexible machine: Easy to reuse and reconfigure machines using NJ Robotics

One controller for high-speed synchronous control of devices and robots

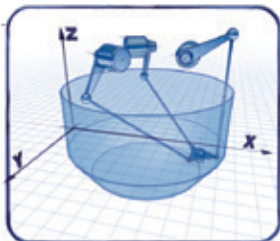

Delta Robot 3 axis

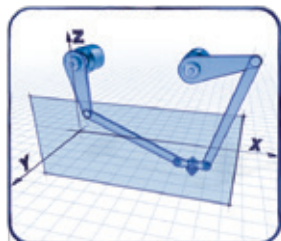

Delta Robot 2 axis

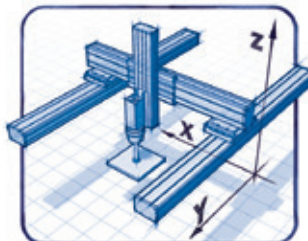

Gantry Robot

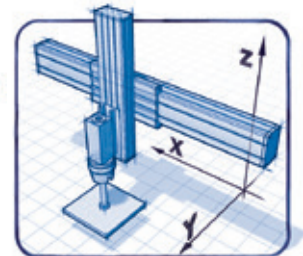

Cartesian Robot 2 axis

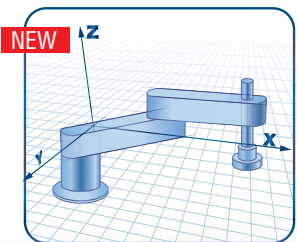

SCARA Robot

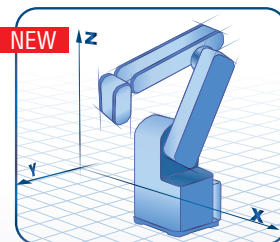

Articulated Robot 3 axis



Machine Automation Controller NJ Robotics CPU Unit

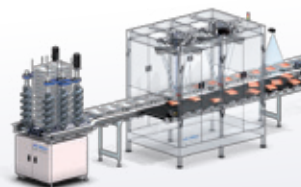

line



The Omron's unique benefits

The new Omron Robotic Automation enhances the most demanding manufacturing lines providing benefits

Performance

Overall through-put is guaranteed by the synchronization of our machine control with the new vision guided robots

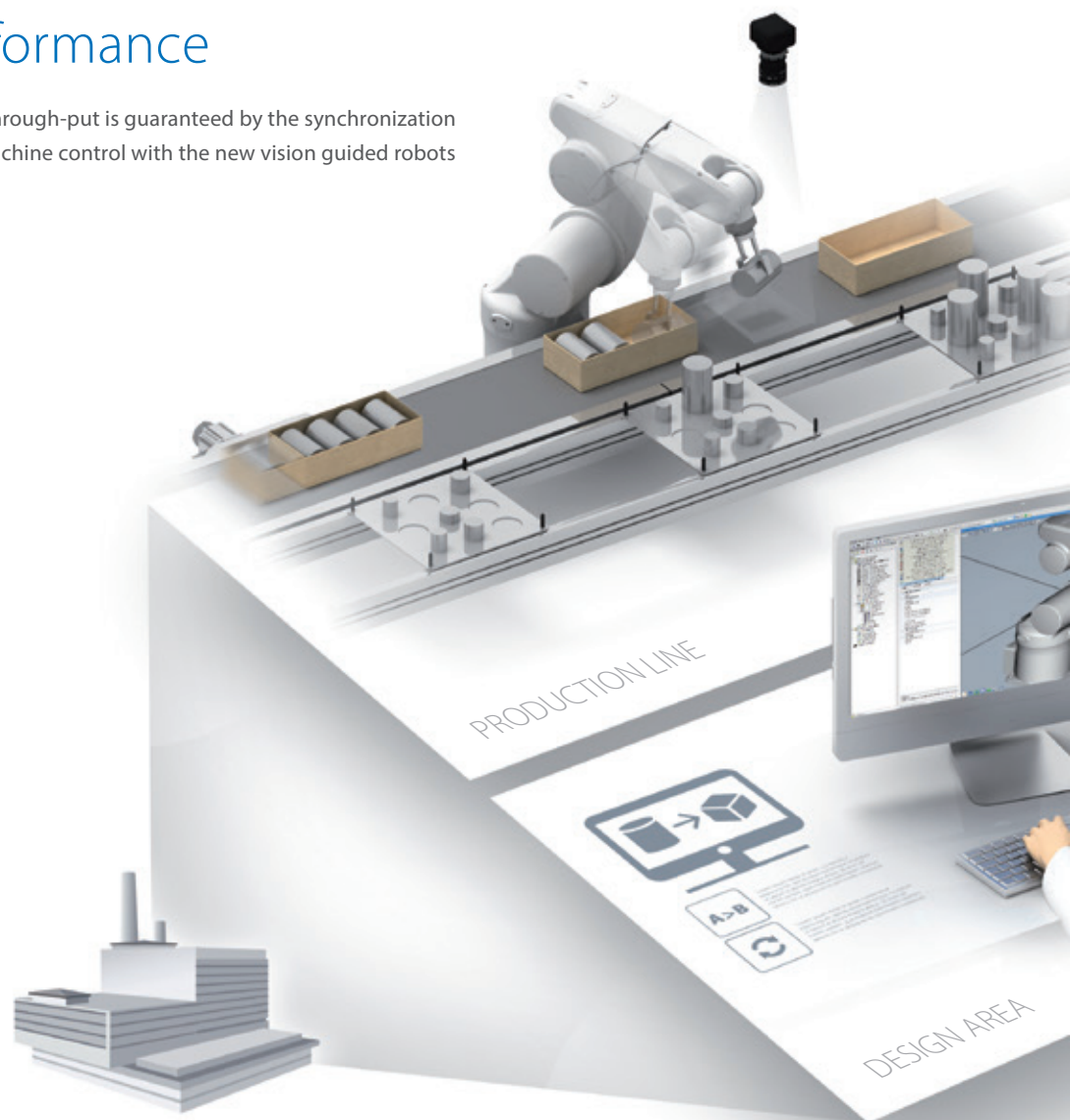

Smart Factory

Quick Delivery

6 huge automated warehouses to provide parts in short time

Simple

Shortening the system verification, startup, and maintenance time by the integrated software environment that bridges real and virtual world

Efficient

All the production data coming from the robots, controllers, sensors, and other devices integrated within the Sysmac concept are collected, shared, and managed to optimize the productivity

Flexible

ACE (software assisted system) generates automatically the new programming code based on the application



Vision-guided robots: Virtual meets Real

The needs for Pick & Place machines using robots and vision sensors are increasing. Our own Robotics and Vision technology provides the most seamless integration achieved into a single software environment. The machines can be analyzed in the virtual environment that allows studying the application in advance, without having the real machine.

< VIRTUAL

Sysmac Studio

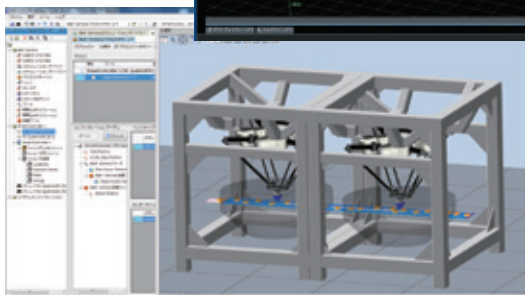
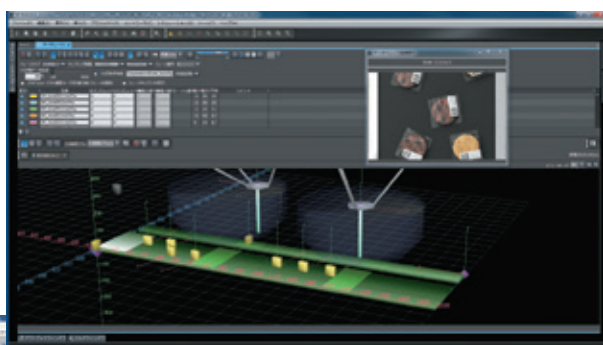

ACE

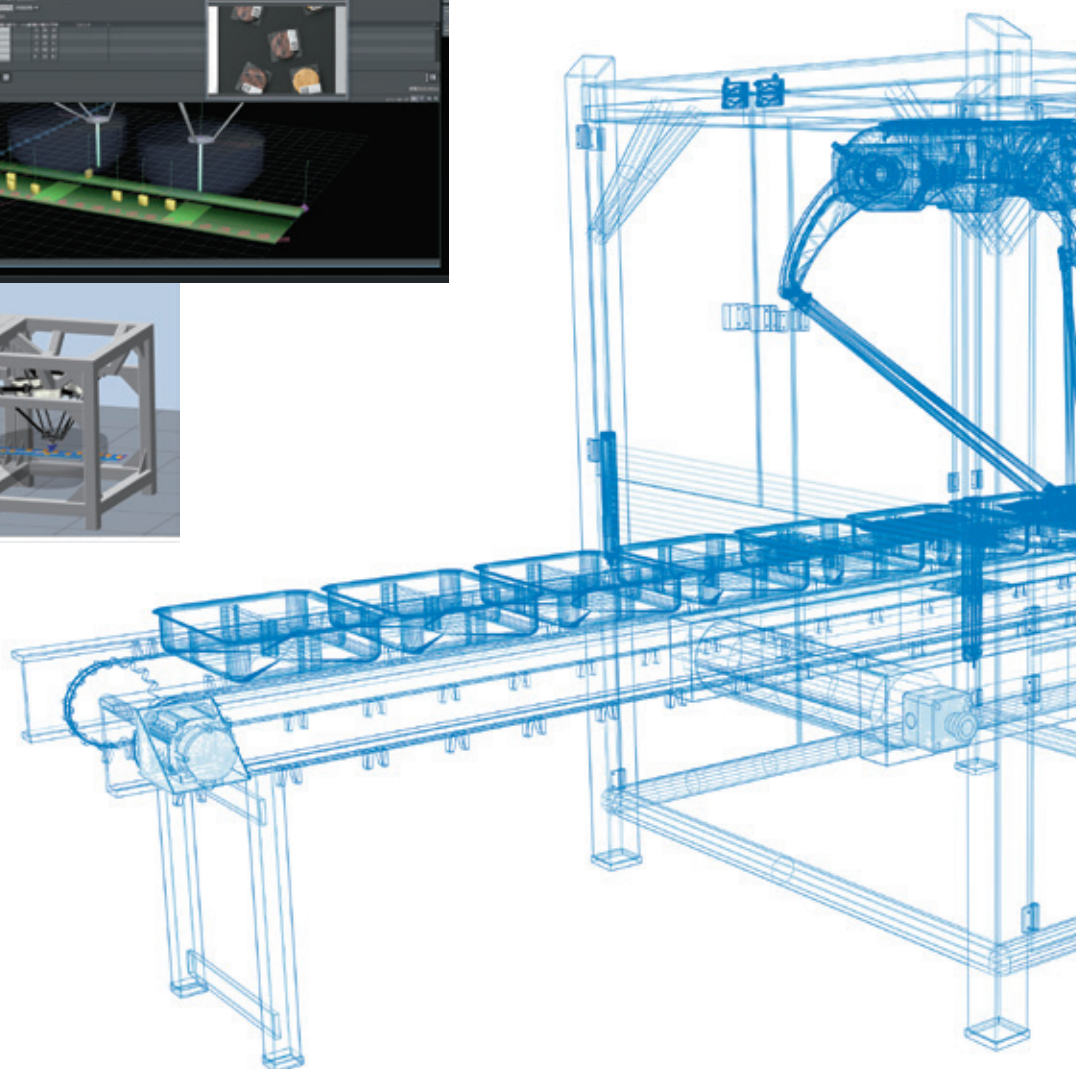

✓ VIRTUAL:

The virtual simulation using the Ace PackXpert or Sysmac Studio is highly reliable since it's based on the same software running in the real robotics and vision system

✓ REAL:

Building high performance Pick & Place machines becomes an easy job thanks to the usability of the fully integrated platform with integrated Vision and Robotics functionality

REAL >

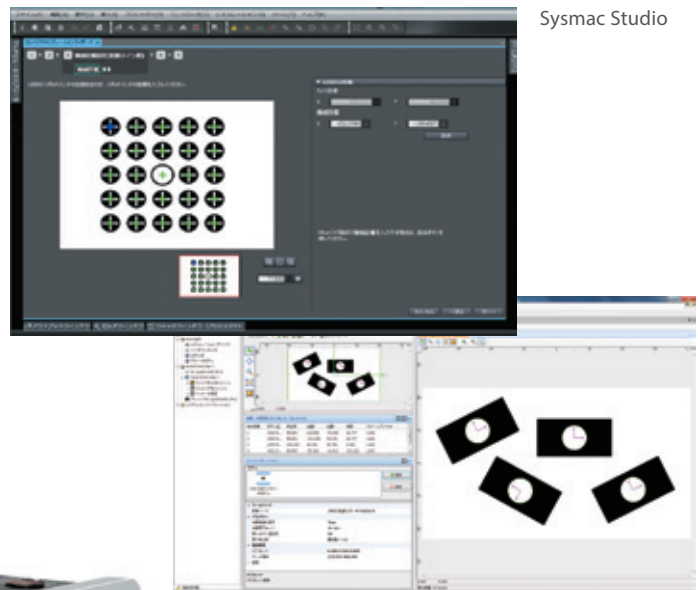

ACE

Benefits include time optimization and reduction for the complete project



Note. In-house comparison. Based on Omron investigation in November 2015.

Total solution for your packaging line

Integration and Functionality

Sysmac is an integrated automation platform dedicated to providing complete control and management of your automation plant.

At the core of this platform, the Machine Controller series offers synchronous control of all machine devices and advanced functionality such as motion, robotics and database connectivity. This multidisciplinary concept allows you to simplify solution architecture, reduce programming and optimize productivity.



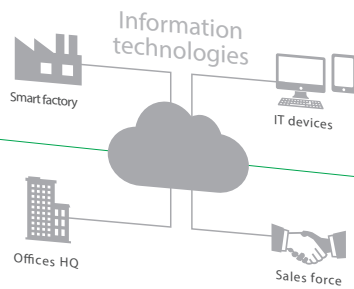
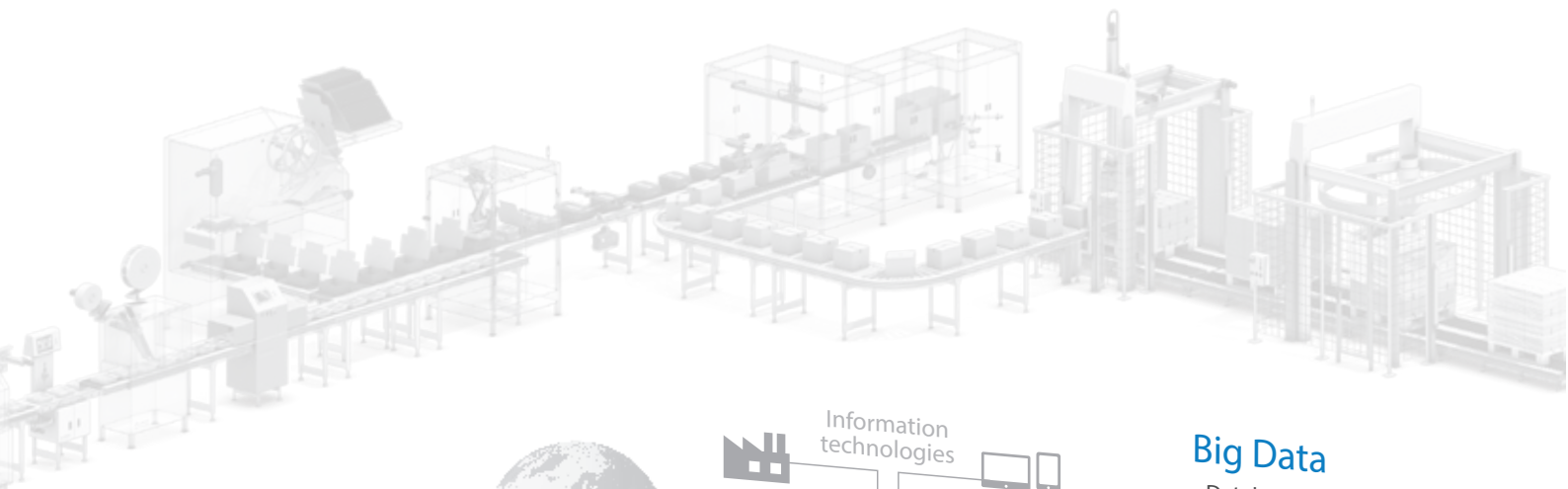

Big Data Database



Ethernet

Flexible line

Flexible machine



Sysmac Library

NJ/NX/NY Controller



Machine Automation Controller
NJ Robotics



Safety
NX Safety



MX2 Inverter



EtherCAT

Motion

G5/1S Servo Drive

Robotics
G5/1S Servo Drive

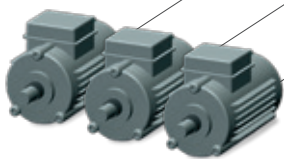

Motors

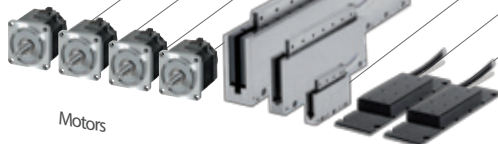

Motors

Linear motors

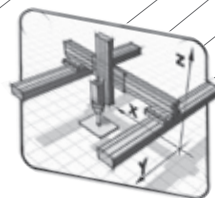

Kinematics

Global robotic service

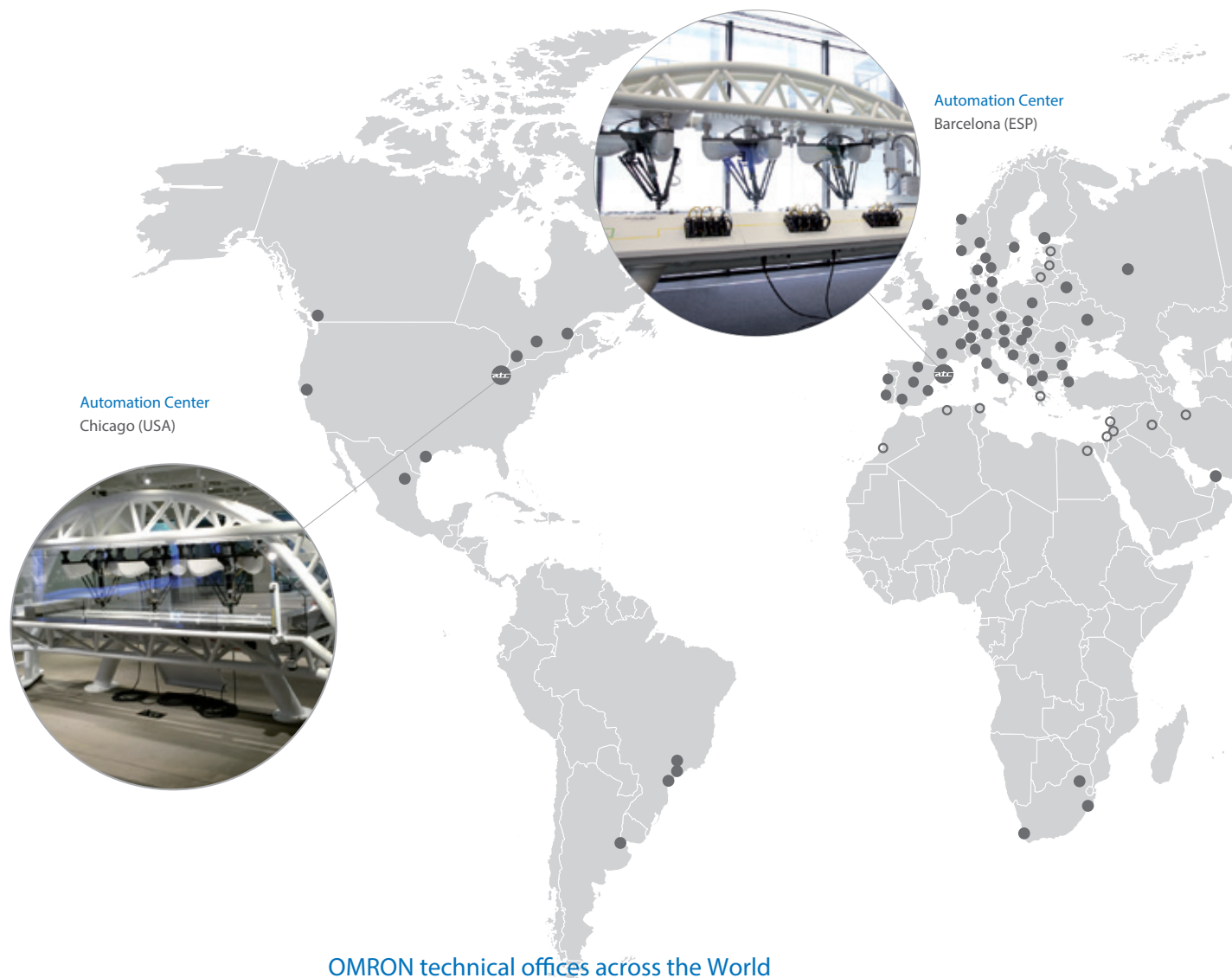

OMRON technical offices across the World

PRESENCE



Automation Center

Mishima (JPN), Shanghai (CHN), Barcelona (ESP), Jakarta (IDN), Mumbai (IND), Chicago (USA), Seoul (KOR)

● Technical office ○ Premium Partner

COMPETENCE

OMRON

Design

Our wide network of machine automation specialists will help you to select the right automation architecture and products to meet your requirements. Our flat structure based on expert-to-expert contact ensures that you will have ONE accountable and responsible expert to deal with on your complete project.

Proof of concept

As your project matures make use of our Automation centers to test and catch-up with technology trends in motion, robotics, networking, safety, quality control etc. Make use of our Tsunagi (connectivity) laboratory to interface, test and validate your complete system with our new machine network (EtherCAT) and factory network (EtherNet/IP).

We will assign a dedicated application engineer to assist with initial programming and proof testing of the critical aspects of your automation system. Our application engineers have in-depth expertise in and knowledge of networks, PLCs, motion, safety and HMIs when applied to machine automation.

Give us a call / Send us your sample / We can simulate the application for you and send you a test report.

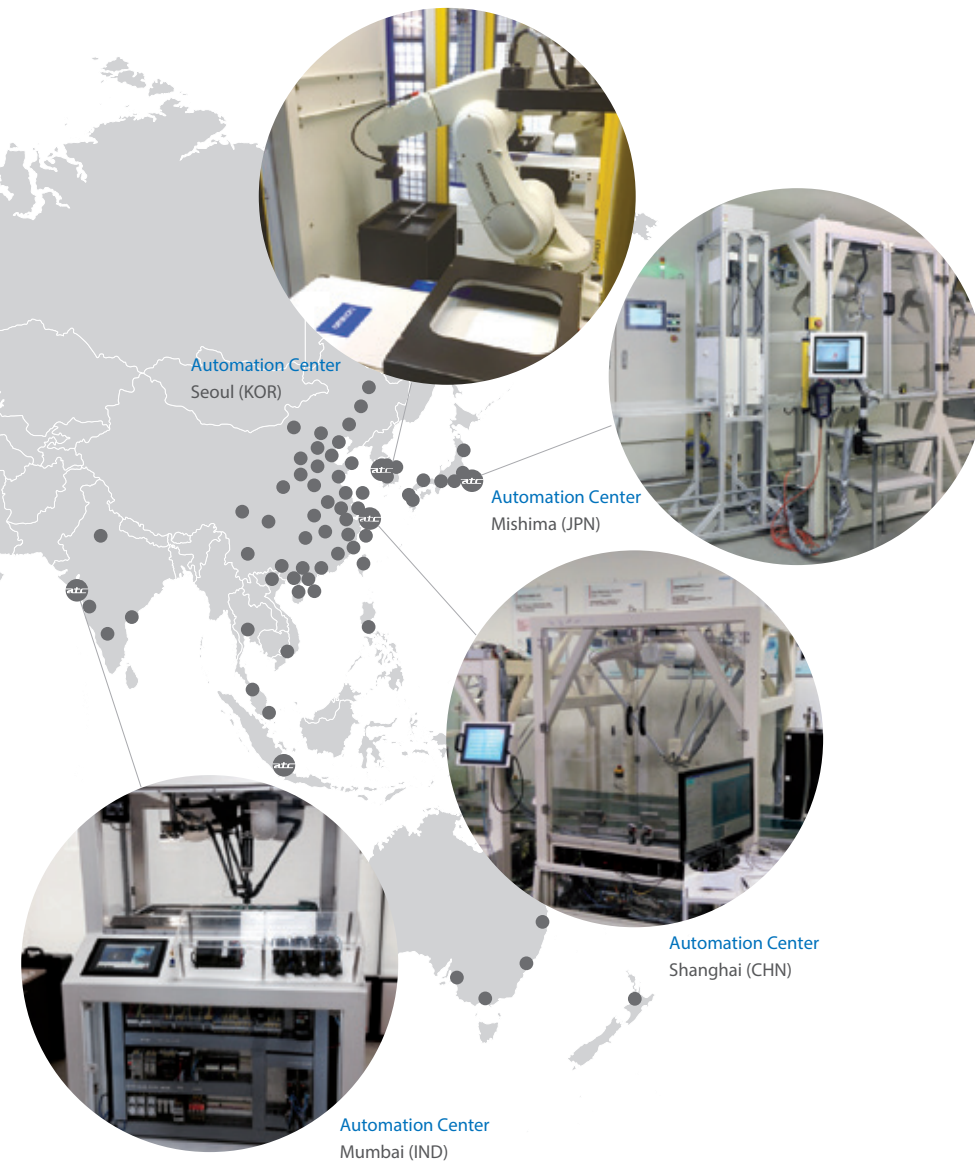

Test report as a service is based on virtual machine simulation and product samples testing:

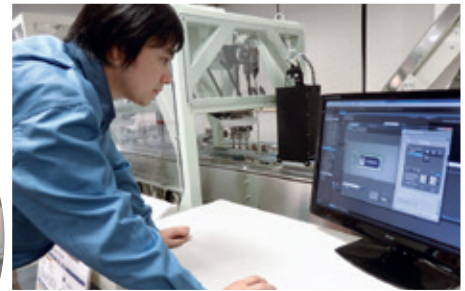

Checking of real product samples



3D machine simulation environment

CONFIDENCE

Development

During your prototyping phase you will need flexibility in technical support, product supply and exchange. We will assign an inside sales contact to help you source the correct products fast during your prototyping phase.

Commissioning

With our world-wide network for service and support the export of your product is made simple, we will support you on-site with your customer, anywhere in the world. We can arrange a liaison sales engineer to facilitate training, spare parts supply or even machine commissioning. All this in a localised language with localised documentation – giving you complete peace of mind.

ASSURANCE

Serial production

As your production increases we will engage in supplying you within 24hrs and repairing within 3 days. All our products are global products meeting global standards - CE, cULus, NK, LR -

Omron continues to develop robot systems to meet your needs.

Omron offers a wide range of solutions ideal for applications in the food and beverage, automotive, and electronic components industries.



· Post-press process (Automotive industry)

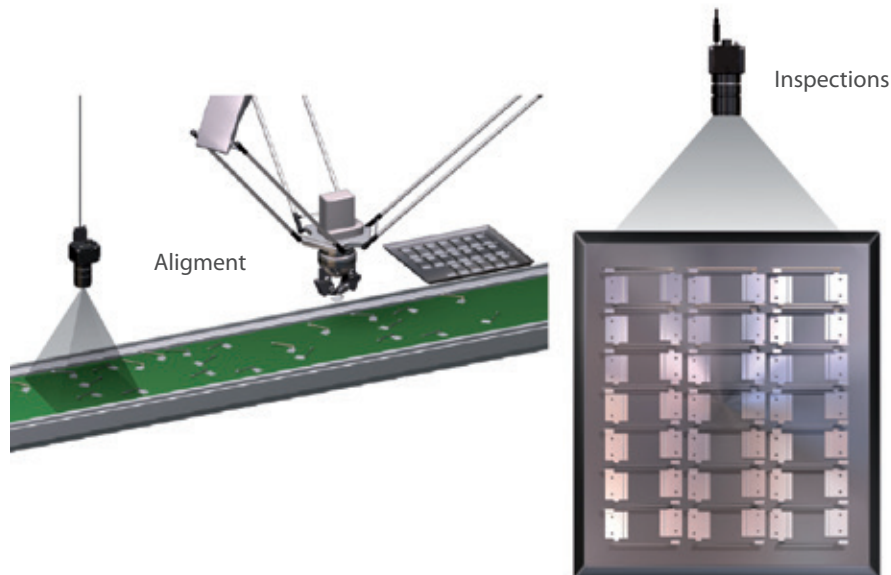

FROM

TO

When both alignment and inspection were performed, individual vision system controllers were required for each process, which consumed space and increased cost. The previous controller that could be connected with two cameras could not process simultaneously due to waiting time.

Up to eight cameras can be connected with one vision system controller, saving space and cost. Parallel processing by a CPU eliminates waiting time and reduces cycle time.

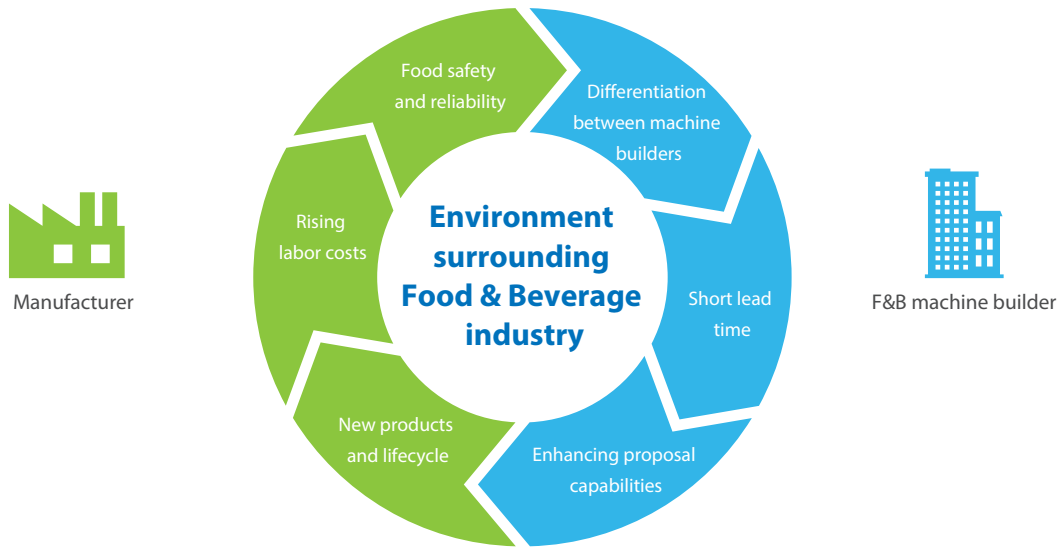

· Packing process (Food & beverage industry)



FROM

TO





Pattern search provided by general vision sensors sometimes could not detect folded laminate pouches or detected the incorrect position, generating picking errors.

Search algorithm Shape Search III can reliably detect objects even under adverse conditions. Accurate picking position measurement minimizes picking errors. The sensor can distinguish the top and bottom of the pouch by detecting characteristic points. This makes more efficient use of the space inside boxes when pouches are packed in boxes.

200,000 products

— Flexible line

CONTROLLERS

				
Product name	NX701	NJ501	NJ301	NJ101
Description	Ideal for large-scale, fast, and highly-accurate control with up to 256 axes.	NJ5 series Machine Controller with Sequence and Motion functionality	NJ3 series Machine Controller with Sequence and Motion functionality	Ideal for simple machines
Software	Sysmac Studio	Sysmac Studio	Sysmac Studio	Sysmac Studio
Programming	<ul style="list-style-type: none"> Ladder (within In-line ST) Structured Text In-line ST 	<ul style="list-style-type: none"> Ladder (within In-line ST) Structured Text In-line ST 	<ul style="list-style-type: none"> Ladder (within In-line ST) Structured Text In-line ST 	<ul style="list-style-type: none"> Ladder (within In-line ST) Structured Text In-line ST
Standard programming	<ul style="list-style-type: none"> IEC 61131-3 PLCopen Function Blocks for Motion Control 	<ul style="list-style-type: none"> IEC 61131-3 PLCopen Function Blocks for Motion Control 	<ul style="list-style-type: none"> IEC 61131-3 PLCopen Function Blocks for Motion Control 	<ul style="list-style-type: none"> IEC 61131-3 PLCopen Function Blocks for Motion Control
Program capacity	80MB	20 MB	5 MB	3MB
Variables capacity	No Retain attribute	256MB	4MB	2MB
	Retain attribute	4MB	2MB	0.5MB
Memory card	SD/SDHC memory card	SD/SDHC memory card	SD/SDHC memory card	SD/SDHC memory card
Built-in ports	<ul style="list-style-type: none"> EtherNet/IP EtherCAT USB 2.0 	<ul style="list-style-type: none"> EtherNet/IP EtherCAT USB 2.0 	<ul style="list-style-type: none"> EtherNet/IP EtherCAT USB 2.0 	<ul style="list-style-type: none"> EtherNet/IP EtherCAT USB 2.0
Number of EtherCAT slaves	512	192	192	64
Number of motion control axes	256, 128	64, 32, 16	8, 4	2, 0
Motion control	<ul style="list-style-type: none"> Axes groups interpolation and single axis moves Electronic cams and gearboxes Direct position control for axis and groups 	<ul style="list-style-type: none"> Axes groups interpolation and single axis moves Electronic cams and gearboxes Direct position control for axis and groups 	<ul style="list-style-type: none"> Axes groups interpolation and single axis moves Electronic cams and gearboxes Direct position control for axis and groups 	<ul style="list-style-type: none"> Axes groups interpolation and single axis moves Electronic cams and gearboxes Direct position control for axis and groups
Ordering information	P072 Sysmac Catalog			



Sysmac Library



The Sysmac Library is a collection of software functional components that can be used in programs for the NJ/NX Machine Automation Controllers or Industrial PC Platform NY IPC Machine Controller.

Please download it from following URL and install to Sysmac Studio Automation Software.







http://www.ia.omron.com/sysmac_library/

- The Adept Robot Control Library allows you to control parallel, SCARA, and articulated robots manufactured by Omron Adept Technologies Inc. from the NJ/NX Machine Automation Controller or Industrial PC Platform NY IPC Machine Controller by using the same instructions and programming methods.

CONTROLLERS

				
Product name		NX1P	NY51□-1	NY53□-1
Description		Compact controller with up to 4-axis motion control, up to 4-axis single-axis control, and built-in I/O	Two operating systems: Windows and Real-Time OS	
Software		Sysmac Studio	Sysmac Studio	Sysmac Studio
Programming		<ul style="list-style-type: none"> Ladder (within in-line ST) Structured Text In-line ST 	<ul style="list-style-type: none"> Ladder (within in-line ST) Structured Text In-line ST 	<ul style="list-style-type: none"> Ladder (within in-line ST) Structured Text In-line ST
Standard programming		<ul style="list-style-type: none"> IEC61131-3 PLCopen Function Blocks for Motion Control 	<ul style="list-style-type: none"> IEC61131-3 PLCopen Function Blocks for Motion Control 	<ul style="list-style-type: none"> IEC61131-3 PLCopen Function Blocks for Motion Control
Program capacity		1.5MB	40MB	
Variables capacity	No Retain attribute	2MB	64MB	
	Retain attribute	32KB	4MB	
Memory card		SD/SDHC memory card	SSD, HDD	
Built-in ports		<ul style="list-style-type: none"> EtherNet/IP EtherCAT 	<ul style="list-style-type: none"> EtherNet/IP EtherCAT USB2.0/3.0 	
Number of EtherCAT slaves		16	192	
Number of motion control axes		4, 2, 0 *	64, 32, 16	
Motion control		<ul style="list-style-type: none"> Axes groups interpolation and single axis moves Electronic cams and gearboxes Direct position control for axis and groups 	<ul style="list-style-type: none"> Axes groups interpolation and single axis moves Electronic cams and gearboxes Direct position control for axis and groups 	<ul style="list-style-type: none"> Axes groups interpolation and single axis moves Electronic cams and gearboxes Direct position control for axis and groups
Ordering information		PT15 NX1P Catalog	PT18 Industrial PC Platform Catalog	

* Motion control axes and 4 single-axis position control axes.

INDUSTRIAL ROBOTS				
				
Product name	Homet 565		Quattro 650/800	Viper 650/850
Robot type	Parallel robot			Articulated robot
Number of axes	3, 4		4	6
Mounting	Inverted		Inverted	Table / Floor / Inverted
Payload capacity	3 kg (8 kg: without rotation axis)		<ul style="list-style-type: none"> • Quattro 650 6 kg (No rotation: 15 kg) • Quattro 800 4 kg (No rotation: 10 kg) 	5 kg
Working volume (Radius)	565 mm		650 to 800 mm	---
Reach	---		---	653 to 855 mm
Position repeatability	±0.10 mm		±0.10 mm	±0.02 to 0.03 mm
Protection/ Cleanroom Classes	Specifications	IP67: arms and platform IP65: underside of robot IP20: topside of robot Class 1000	<ul style="list-style-type: none"> • H type IP67: arms and platform Class 1000 • HS type IP67: arms and platform IP66: robot base Class 1000 	IP40
	Option	IP65: topside of robot	<ul style="list-style-type: none"> • H type IP65: robot base 	IP54: robot main body IP65: robot joints (J4, J5, J6) Class10 Cleanroom model
Ordering information		I822 Industrial Robots Datasheets		
				
Product name	Cobra 350		eCobra 600/800	eCobra 800 Inverted
Robot type	SCARA robot			
Number of axes	4		4	4
Mounting	Table / Floor		Table / Floor	Inverted
Payload capacity	5 kg		5.5 kg	5.5 kg
Working volume (Radius)	---		---	---
Reach	350 mm		600 to 800 mm	800 mm
Position repeatability	±0.015 mm		±0.017 mm	±0.017 mm
Protection/ Cleanroom Classes	Specifications	IP20	IP20	IP20
	Option	Class10 Cleanroom model	<ul style="list-style-type: none"> • eCobra 600 Class10 Cleanroom model • eCobra 800 IP65, Class10 Cleanroom model 	IP65, Class10 Cleanroom model
Ordering information		I822 Industrial Robots Datasheets		

MOBILE ROBOTS



Product name		LD	
Robot type	Mobile robot		
Product type	OEM	Cart Transporter	
Maximum load	60, 90 kg	105, 130 kg	
Maximum speed	1.8 m/s, 1.35 m/s	1.35 m/s, 0.9 m/s	
Maximum rotation speed	300°/s, 225°/s	180°/s	
Stop position accuracy	± 100 mm: Position, ± 2°: Rotation (±10 mm: Position, ±0.5°: Rotation with option (High Accuracy Positioning System))		
Protection/Cleanroom Classes	IP20 Class 100	IP20	
Ordering information	I828 Mobile Robots Datasheet		

— Flexible Machine

MACHINE CONTROLLERS



Product name		NJ- series Robotics
		NJ501
Description		Machine Controller with Sequence, Motion and Robotics functionality
Software		Sysmac Studio
Programming		<ul style="list-style-type: none"> Ladder (within In-line ST) Structured Text In-line ST
Standard programming		<ul style="list-style-type: none"> IEC 61131-3 PLCopen Function Blocks for Motion Control
Program capacity		20 MB
Variables capacity	No Retain attribute	4MB
	Retain attribute	2MB
Memory card		SD/SDHC memory card
Built-in ports		<ul style="list-style-type: none"> EtherNet/IP EtherCAT USB 2.0
Number of EtherCAT slaves		192
Number of axes		64, 32, 16
Motion control		<ul style="list-style-type: none"> Axes groups interpolation and single axis moves Electronic cams and gearboxes Direct position control for axis and groups Up to 8 parallel, Cartesian, and serial robot control
Ordering information		P072 Sysmac Catalog

— Lineup for Omron Robotic Automation

SOFTWARE

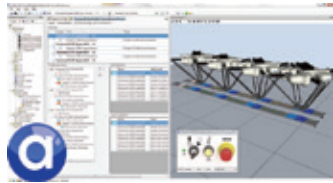

Model	Automation Control Environment (ACE)	Sysmac Studio Standard Edition Ver.1.□□	Sysmac Library
	<p>The ACE is a PC-based software package that helps you quickly and easily set up your robot system. The software makes it easy to configure single and multi-robot systems.</p> <p>ACE PackXpert is the intelligent software choice designed to manage packaging systems from integration to deployment</p> <ul style="list-style-type: none"> • ACE PackXpert provides the underlying robot programming based on the system configuration • Built-in customization allows for any line configuration and advanced load balancing • Wizard-based user-friendly interface to calibrate and teach the robots • Tightly-integrated vision option (ACE Sight) enables vision-guided conveyor-tracking 	<p>The Sysmac Studio is the software that provides an integrated environment for setting, programming, debugging and maintenance of machine automation controllers including the NJ/NX CPU Units, NY Industrial PC, EtherCAT Slave, and the HMI.</p> <ul style="list-style-type: none"> • One software for motion, logic sequencing, safety, drives, vision and HMI • Fully compliant with open standard IEC 61131-3 • Supports Ladder, Structured Text and Function Block programming with a rich instruction set • CAM editor for easy programming of complex motion profiles • One simulation tool for sequence and motion in a 3D environment • Advanced security function with 32 digit security password • IEC standard and PLCopen Function Blocks for Motion Control and Safety <p>Robot Additional Option* Sysmac Studio Robot Additional Option is a license to enable the Vision & Robot integrated simulation.</p>	<p>The Sysmac Library is a collection of software functional components that can be used in programs for the NJ/NX Machine Automation Controllers or Industrial PC Platform NY IPC Machine Controller. Packed with Omron's rich technical know-how on control programs, the Sysmac Library makes advanced control easy. Install the Sysmac Library to use it in the Sysmac Studio.</p> <ul style="list-style-type: none"> • For a wide range of applications • Available to download from OMRON's website • High quality product with reliable global support <p>SYSMAC-XR009 Adept Robot Control Library The Adept Robot Control Library allows parallel, SCARA, and articulated robots manufactured by Omron Adept Technologies Inc. to be controlled directly from the NJ/NX Machine Automation Controller or Industrial PC Platform NY IPC Machine Controller by using the same instructions and programming method as the controller.</p>
Ordering information	I822 Industrial Robots Datasheets	P072 Sysmac Catalog	

* This product is a license only. You need the Sysmac Studio Standard Edition DVD media to install it.

VISION SENSORS







Series		FH
Product name		Vision System
Hardware features		Flexible configuration of cameras and controller to suit your applications
Software FEATURE		Flexible setting with flowchart
Processing items		Processing items covering general applications
Processing resolution	300,000 pixels	640 (H) x 480 (V)
	2 million pixels	2040 (H) x 1088 (V)
	4 million pixels	2040 (H) x 2048 (V)
	12 million pixels	4084(H)x3072(V)
Communications interfaces		EtherCAT, Ethernet, parallel I/O, encoder input
Ordering information		P072 Sysmac Catalog

PROGRAMMABLE TERMINALS



Model	NA5-15W	NA5-12W	NA5-9W	NA5-7W
Display device	TFT LCD	TFT LCD	TFT LCD	TFT LCD
Screen size	15.4-inch widescreen	12.1-inch widescreen	9.0-inch widescreen	7.0-inch widescreen
Resolution	1280 x 800 dots (horizontal x vertical)	1280 x 800 dots (horizontal x vertical)	800 x 480 dots (horizontal x vertical)	800 x 480 dots (horizontal x vertical)
Colors	16,770,000 colors (24 bit full colors)	16,770,000 colors (24 bit full colors)	16,770,000 colors (24 bit full colors)	16,770,000 colors (24 bit full colors)
Operation	<ul style="list-style-type: none"> • Touch panel: analog resistance membrane (pressure sensitive) • Function keys: 3 inputs (capacitance inputs) 	<ul style="list-style-type: none"> • Touch panel: analog resistance membrane (pressure sensitive) • Function keys: 3 inputs (capacitance inputs) 	<ul style="list-style-type: none"> • Touch panel: analog resistance membrane (pressure sensitive) • Function keys: 3 inputs (capacitance inputs) 	<ul style="list-style-type: none"> • Touch panel: analog resistance membrane (pressure sensitive) • Function keys: 3 inputs (capacitance inputs)
Built-in ports	<ul style="list-style-type: none"> • 2 Ethernet ports • 2 USB host ports • 1 USB slave port 	<ul style="list-style-type: none"> • 2 Ethernet ports • 2 USB host ports • 1 USB slave port 	<ul style="list-style-type: none"> • 2 Ethernet ports • 2 USB host ports • 1 USB slave port 	<ul style="list-style-type: none"> • 2 Ethernet ports • 2 USB host ports • 1 USB slave port
Allowable power supply voltage range	19.2 to 28.8VDC	19.2 to 28.8VDC	19.2 to 28.8VDC	19.2 to 28.8VDC
Programming software	Sysmac Studio	Sysmac Studio	Sysmac Studio	Sysmac Studio
Degree of protection	Front-panel controls: IP65 oil-proof type	Front-panel controls: IP65 oil-proof type	Front-panel controls: IP65 oil-proof type	Front-panel controls: IP65 oil-proof type
Memory card	SD/SDHC memory card	SD/SDHC memory card	SD/SDHC memory card	SD/SDHC memory card
Features	<ul style="list-style-type: none"> • Sharing NJ controller variables in the NA project • Increased security with password protection • Visual Basic programming • Testing NA with the NJ control program via Simulator in Sysmac Studio 	<ul style="list-style-type: none"> • Sharing NJ controller variables in the NA project • Increased security with password protection • Visual Basic programming • Testing NA with the NJ control program via Simulator in Sysmac Studio 	<ul style="list-style-type: none"> • Sharing NJ controller variables in the NA project • Increased security with password protection • Visual Basic programming • Testing NA with the NJ control program via Simulator in Sysmac Studio 	<ul style="list-style-type: none"> • Sharing NJ controller variables in the NA project • Increased security with password protection • Visual Basic programming • Testing NA with the NJ control program via Simulator in Sysmac Studio
Frame colors	Black, silver	Black, silver	Black, silver	Black, silver
Ordering information	P072 Sysmac Catalog			

I/O			
			
Series	NX		GX
Type	Modular I/O		Block I/O
Communications interface	EtherCAT		EtherCAT
Number of connectable units	<ul style="list-style-type: none"> 63 units max. Input: 1,024 bytes max., output: 1,024 bytes max. 		One expansion unit can be connected with one digital I/O terminal (16 inputs + 16 outputs)
I/O types	<ul style="list-style-type: none"> Digital I/O Pulse output 	<ul style="list-style-type: none"> Analog I/O Temperature input 	<ul style="list-style-type: none"> Encoder input Safety
Features	<ul style="list-style-type: none"> Over 100 models of I/O units including position interface, temperature inputs and integrated safety High-speed I/O units synchronized with the EtherCAT cycle NsynX technology provides deterministic I/O response with nanosecond resolution Detachable front connector with push-in type screw-less terminals in all NX I/O units Up to 32 digital inputs or outputs 		<ul style="list-style-type: none"> Wide variety of lineup: digital I/O, analog I/O, and encoder input units Easy maintenance: removable I/O terminal Easy set-up: automatic and manual address setting
Mounting	DIN track		DIN track
Ordering information	P072 Sysmac Catalog		

SAFETY			
			
Product name	NX Safety CPU Unit	NX Safety Input Unit	NX Safety Output Unit
Network	FSoE – Safety over EtherCAT	FSoE – Safety over EtherCAT	FSoE – Safety over EtherCAT
Applicable Standards	EN ISO 13849-1, 2 (PLe/Safety Category 4), IEC 61508 (SIL3), EN 62061 (SIL CL3), EN 61131-2	EN ISO 13849-1, 2 (PLe/Safety Category 4), IEC 61508 (SIL3), EN 62061 (SIL CL3), EN 61131-2	EN ISO 13849-1, 2 (PLe/Safety Category 4), IEC 61508 (SIL3), EN 62061 (SIL CL3), EN 61131-2
Programming	<ul style="list-style-type: none"> IEC 61131-3 standard PLCopen Function Blocks for Safety 	---	---
Number of safety master connections	32/128	---	---
Number of safety input/output points	---	<ul style="list-style-type: none"> 4 points 8 points 	<ul style="list-style-type: none"> 2 points 4 points
Number of test output points	---	2 points	---
Terminal block	---	Screwless clamping terminal block	Screwless clamping terminal block
Features	<ul style="list-style-type: none"> Freely mixing with standard NX I/O Reusable certified programs NX variables sharing in the NJ controller project 	<ul style="list-style-type: none"> Freely mixing with standard NX I/O The 4-point unit can be directly connected with OMRON non-contact switches and singlebeam sensors I/O data monitoring in the NJ controller project 	<ul style="list-style-type: none"> Freely mixing with standard NX I/O The 2-point unit is characterized by large output breaking current of 2.0 A I/O data monitoring in the NJ controller project
Mounting	DIN track	DIN track	DIN track
Ordering information	P072 Sysmac Catalog		

SERVOMOTORS/LINEAR MOTORS/DRIVES



Product name	G5 Servo Drives	1S Servo Drives
Type	Built-in EtherCAT Communications	Built-in EtherCAT Communications
Linear Type	Yes (Refer to the G5 Series Catalog (Cat.No.I815) for details.)	No
100 VAC Applicable motor capacity/force	50 to 400 W	100 to 400W
200 VAC Applicable motor capacity/force	50 W to 15 kW	100 to 3kW
400 VAC Applicable motor capacity/force	400 W to 15 kW	600 to 3kW
Applicable servomotor	G5 rotary servomotor	1S servomotor
Control mode	Position, speed and torque control	Position, speed and torque control
Safety approvals	<ul style="list-style-type: none"> ISO13849-1 (PL-c,d) EN61508 (SIL2) EN62061 (SIL2) IEC61800-5-2 (STO) 	<ul style="list-style-type: none"> ISO13849-1 (PL-e/PL-d) EN61508 (SIL3/SIL2) EN62061 (SIL3/SIL2) IEC61800-5-2 (STO)
Full closed loop	Built-in	No
Ordering information	P072 Sysmac Catalog	





Product name	G5 Servomotors		1S Servomotors	
Rated rotation speed	3,000 r/min	2,000 r/min	3,000 r/min	2,000 r/min
Momentary maximum rotation speed	4,500 to 6,000 r/min	3,000 r/min	5000 to 6000 r/min	3000 r/min
Rated torque	0.16 to 15.9 Nm	1.91 to 23.9 Nm	0.318 to 9.55N-m	4.77 to 14.3 N-m
Capacity	50 W to 5 kW	400 W to 5 kW	100W to 3 kW	400W to 3kW
Applicable servo drive	G5 Servo Drive (for rotary servomotor)		1S Servo Drive	
Encoder resolution	20-bit incremental/ 17-bit absolute	20-bit incremental/ 17-bit absolute	23-bit absolute	23-bit absolute
Protective structure	IP67	IP67	IP67	IP67
Ordering information	P072 Sysmac Catalog			







Product name	G5 Servomotors		1S Servomotors	
Rated rotation speed	1,500 r/min	1,000 r/min	1,000 r/min	
Momentary maximum rotation speed	2,000 to 3,000 r/min	2,000 r/min	2000 r/min	
Rated torque	47.8 to 95.5 Nm	8.59 to 57.3 Nm	8.59 to 28.7 N-m	
Capacity	7.5 to 15 kW	900 W to 6 kW	900 W to 3kW	
Applicable servo drive	G5 Servo Drive (for rotary servomotor)		1S Servo Drive	
Encoder resolution	17-bit absolute	20-bit incremental/ 17-bit absolute	23-bit absolute	
Protective structure	IP67	IP67	IP67	
Ordering information	P072 Sysmac Catalog			

INVERTERS

		
Series	RX-V1	MX2-V1
Three-phase 400 V	0.4 to 132 kW	0.4 to 15 kW
Three-phase 200 V	0.4 to 55 kW	0.1 to 15 kW
Single-phase 200 V	---	0.1 to 2.2 kW
Control methods	<ul style="list-style-type: none"> V/F control Sensorless vector control Vector control with a PG 	<ul style="list-style-type: none"> V/F control Sensorless vector control
Starting torque	<ul style="list-style-type: none"> 200% at 0.3 Hz in open loop Full torque at 0 Hz in closed loop 	200% at 0.5 Hz
Communications	Optional EtherCAT communication unit	Optional EtherCAT communication unit
PLC functionality (Drive Programming)	Provided as standard	Provided as standard
Ordering information	P072 Sysmac Catalog	

DISPLACEMENT/FIBER/LASER/CONTACT/PROXIMITY SENSORS

				
Series	ZW-7000	ZW	Fiber/Laser/Contact Sensors N-Smart	Fiber/Laser/Proximity Sensors E3X/E3C/E2C
Measurement method	White light confocal principle	White light confocal principle	---	---
Applications	Height, thickness	Height, thickness	---	---
Measuring range	Min: 10±0.5 mm, Max: 30±2 mm	Min: 7 ± 0.3 mm, Max: 40 ± 6 mm	---	---
Static resolution	0.004 to 0.016 μm	0.01 to 0.08 μm	---	---
Linearity	±0.45 to 2.0 μm	±0.8 to 9.3 μm	---	---
Features	<ul style="list-style-type: none"> Measuring shiny objects with an inclination of ±25° ±0.5 μm or less linearity for various materials Ultra-compact, Lightweight sensor Synchronous control and setting of multiple sensors via Ethernet Wide variety of interfaces (EtherCAT/Ethernet/RS-232C/Analog voltage and current) 	<ul style="list-style-type: none"> Ultra-compact sensing head Easy to install and high resolution Synchronous control and setting of multiple sensors via Ethernet Wide variety of interfaces (EtherCAT/Ethernet/RS-232C/Analog voltage and current) 	Connect fiber, laser and contact sensors to EtherCAT at low initial cost	Easily connect fiber, laser photoelectric and proximity sensors to EtherCAT
Network specification	---	---	EtherCAT communication unit	EtherCAT communication unit
Maximum connectable sensors	---	---	30	30
Connectable sensor amplifier units	---	---	<ul style="list-style-type: none"> E3NX-FAO E3NX-CAO E3NC-LAO E3NC-SAO E9NC-TAO 	<ul style="list-style-type: none"> E3X-HDO E3X-MDAO E3C-LDAO E2C-EDAO
Mounting	DIN track (controller)	DIN track (controller)	DIN track	DIN track
Ordering information	P072 Sysmac Catalog			

OMRON Corporation Industrial Automation Company
Kyoto, JAPAN

Contact: www.ia.omron.com

Regional Headquarters

OMRON EUROPE B.V.

Wegalaan 67-69, 2132 JD Hoofddorp
The Netherlands
Tel: (31)2356-81-300/Fax: (31)2356-81-388

OMRON ASIA PACIFIC PTE. LTD.

No. 438A Alexandra Road # 05-05/08 (Lobby 2),
Alexandra Technopark,
Singapore 119967
Tel: (65) 6835-3011/Fax: (65) 6835-2711

OMRON ELECTRONICS LLC

2895 Greenspoint Parkway, Suite 200
Hoffman Estates, IL 60169 U.S.A.
Tel: (1) 847-843-7900/Fax: (1) 847-843-7787

OMRON (CHINA) CO., LTD.

Room 2211, Bank of China Tower,
200 Yin Cheng Zhong Road,
PuDong New Area, Shanghai, 200120, China
Tel: (86) 21-5037-2222/Fax: (86) 21-5037-2200

Authorized Distributor:

© OMRON Corporation 2015-2017 All Rights Reserved.
In the interest of product improvement,
specifications are subject to change without notice.

CSM_4_1_0317

Cat. No.Y127-E1-04

0317(1115)