

# Flexible Safety Unit

# G9SX

CSM\_G9SX\_DS\_E\_7\_3

## Logical AND Function Adds Flexibility to I/O Expansion

- Facilitates partial or complete control system setup.
- Solid-state outputs (excluding Expansion Units).
- Detailed LED indications enable easy diagnosis.
- TÜV SÜD certification for compliance with IEC/EN61508 (SIL3), EN ISO13849-1 (PLe/Safety Category 4).
- Approved by UL and CSA.
- New unit joins the Series with the following two additional features:
  - OFF-delay time of up to 150 seconds can be set.
  - Two logical AND connection inputs

 Be sure to read the "Safety Precautions" on page 47.



# Application Examples

## Parts Processing Machine

- The entire device stops when the emergency stop switch is pressed.
- Only the processing section stops when the Safety Light Curtain is interrupted.

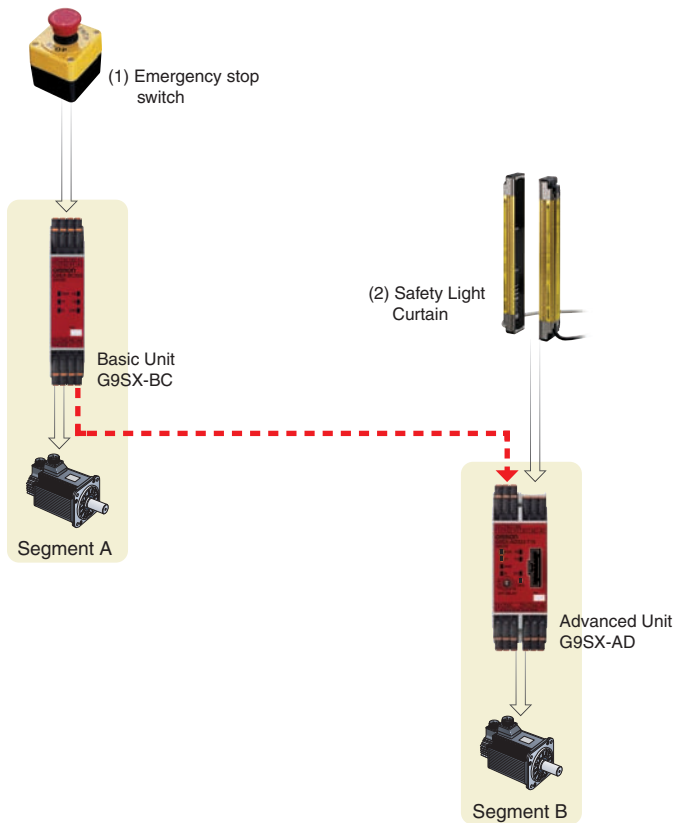
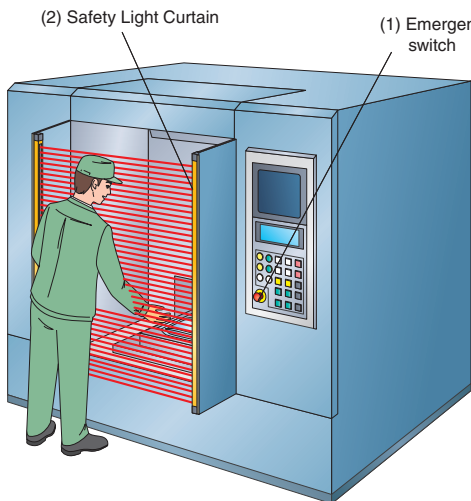

### Operating Example

- (1) The emergency stop switch is pressed.
- (2) Safety Light Curtain is interrupted.



## Machining Center

- When the Emergency Stop Switch is pressed, the entire machine will stop.
- When a door is open, the corresponding part will not be activated.

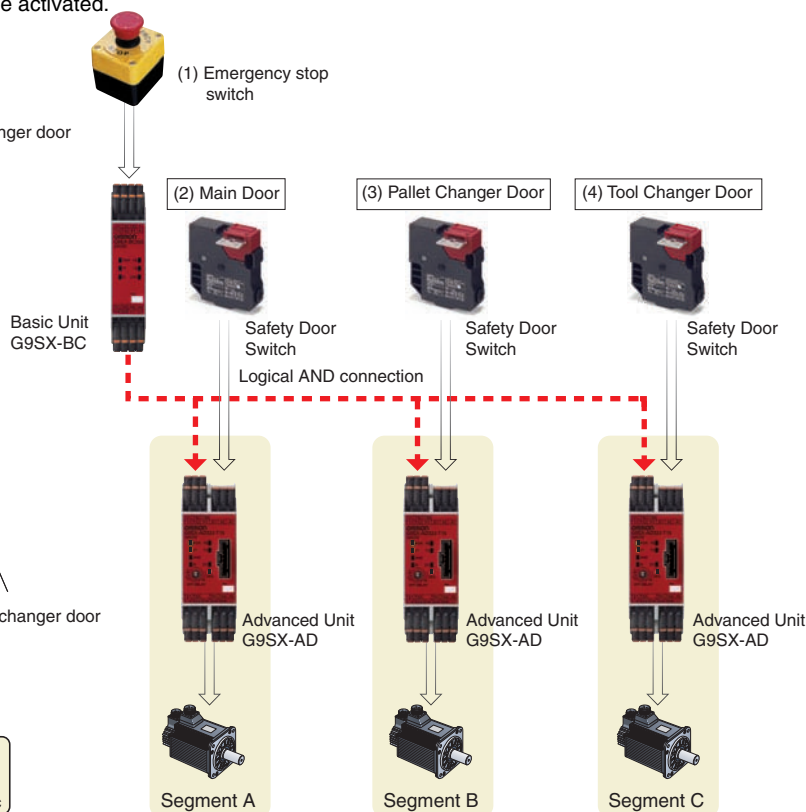
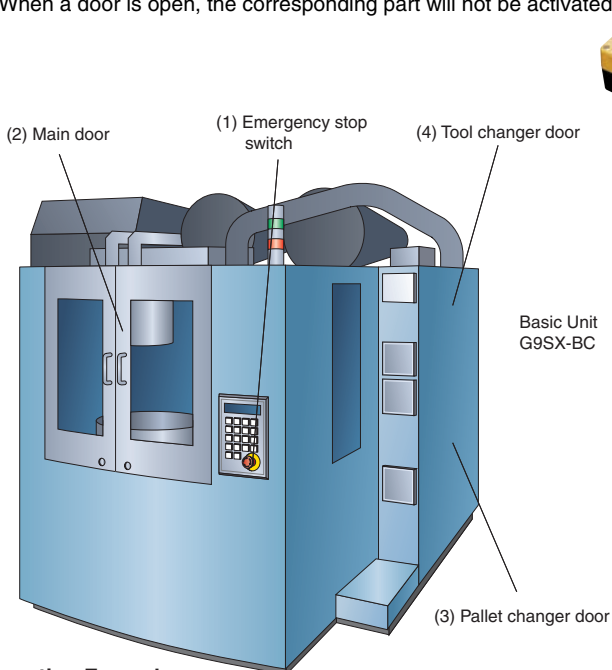

### Operating Example

- (1) The emergency stop switch is pressed.
- (2) The main door is opened.

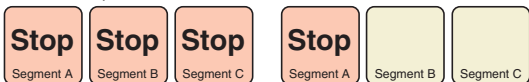

- (3) The pallet changer door is opened.
- (4) The tool changer door is opened.



### Semiconductor Manufacturing Equipment

- All of the equipment stops when the emergency stop switch is pressed.
- The processing section and conveyor section stop when the processing section cover is opened.
- Only the conveyor section stops when the conveyor section cover is opened.

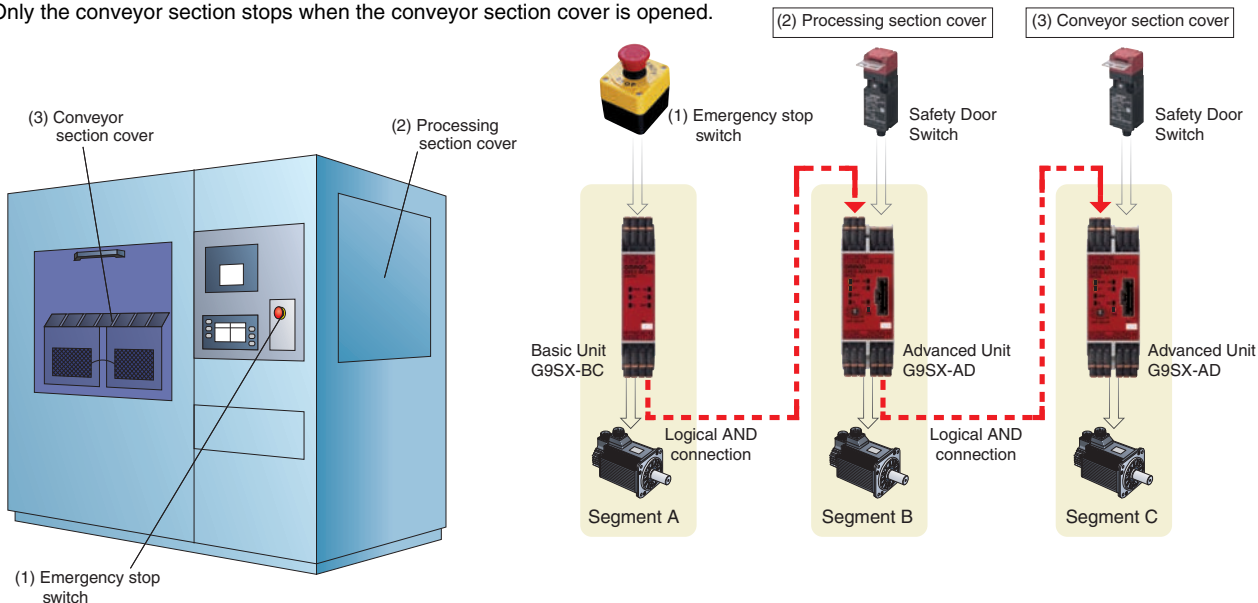

#### Operating Example

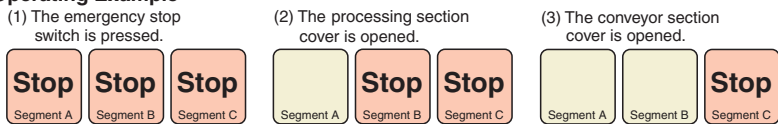

### Machine Tool

- When the Emergency Stop Switch is pressed, the entire machine will stop.
- If the left door is opened, the left drive section and transport section will stop.
- If the right door is opened, the right drive section and transport section will stop.

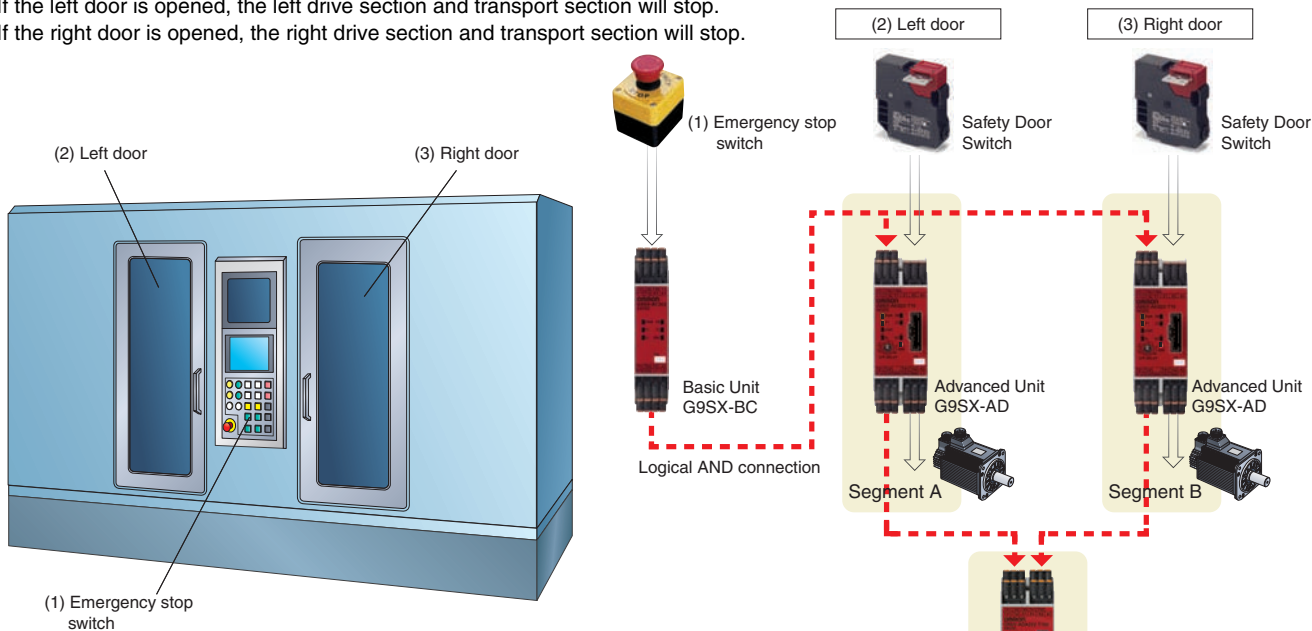

#### Operating Example

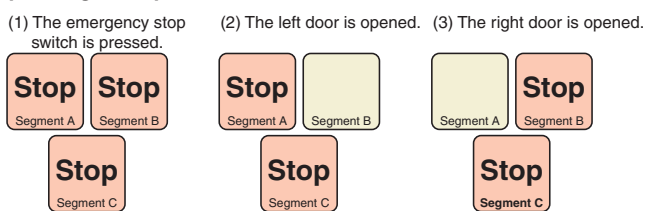

## Model Number Structure

### Model Number Legend

G9SX-□□□□□□-□□□□-□□□

1    2 3 4    5    6

**Note:** Please see "Ordering Information" below for the actual models that can be ordered.

#### 1. Functions

AD/ADA: Advanced Unit  
BC: Basic Unit  
EX: Expansion Unit

#### 2. Output Configuration (Instantaneous Safety Outputs)

0: None  
2: 2 outputs  
3: 3 outputs  
4: 4 outputs

#### 3. Output Configuration (OFF-delayed Safety Outputs)

0: None  
2: 2 outputs  
4: 4 outputs

#### 4. Output Configuration (Auxiliary Outputs)

1: 1 output  
2: 2 outputs

#### 5. Max. OFF-delay Time

Advanced Unit

T15: 15 s  
T150: 150 s

Basic Unit

No indicator: No OFF delay

Expansion Unit

No indicator: No OFF delay

T: OFF delay

#### 6. Terminal Block Type

RT: Screw terminals  
RC: Spring-cage terminals

## Ordering Information

### List of Models

#### Advanced Unit

Safety outputs *3		Auxiliary outputs *4	Logical AND connection		No. of input channels	Max. OFF-delay time *1	Rated voltage	Terminal block type	Model
Instantaneous	OFF-delayed *2		Inputs	Outputs					
3 (Semiconductor)	2 (Semiconductor)	2 (Semiconductor)	1 (Semi-conductor)	1 (Semi-conductor)	1 or 2 channels	15 s	24 VDC	Screw terminals	G9SX-AD322-T15-RT
								Spring-cage terminals	G9SX-AD322-T15-RC
	15 s		Screw terminals	G9SX-AD322-T150-RT					
			Spring-cage terminals	G9SX-AD322-T150-RC					
2 (Semiconductor)	2 (Semiconductor)	2 (Semiconductor)	2 (Semi-conductor)	2 (Semi-conductor)	1 or 2 channels	15 s	24 VDC	Screw terminals	G9SX-ADA222-T15-RT
								Spring-cage terminals	G9SX-ADA222-T15-RC
	150 s		Screw terminals	G9SX-ADA222-T150-RT					
			Spring-cage terminals	G9SX-ADA222-T150-RC					

\*1. The OFF-delay time can be set in 16 steps as follows:

T15: 0/0.2/0.3/0.4/0.5/0.6/0.7/1/1.5/2/3/4/5/7/10/15 s

T150: 0/10/20/30/40/50/60/70/80/90/100/110/120/130/140/150 s

\*2. The OFF-delayed output becomes an instantaneous output by setting the OFF-delay time to 0 s.

\*3. P channel MOS-FET output

\*4. PNP transistor output

#### Basic Unit

Safety outputs *1		Auxiliary outputs *2	No. of input channels	Rated voltage	Terminal block type	Model
Instantaneous	OFF-delayed					
2	---	2 (Semiconductor)	1 or 2 channels	24 VDC	Screw terminals	G9SX-BC202-RT
					Spring-cage terminals	G9SX-BC202-RC

\*1. P channel MOS-FET output

\*2. PNP transistor output

#### Expansion Unit

Safety outputs		Auxiliary outputs *1	OFF-delay time	Rated voltage	Terminal block type	Model	
Instantaneous	OFF-delayed						
4 PST-NO	---	1 (Semiconductor)	---	24 VDC	Screw terminals	G9SX-EX401-RT	
					Spring-cage terminals	G9SX-EX401-RC	
---	4 PST-NO		*2			Screw terminals	G9SX-EX041-T-RT
						Spring-cage terminals	G9SX-EX041-T-RC

\*1. PNP transistor output

\*2. The OFF-delay time is synchronized to the OFF-delay time setting in the connected Advanced Unit (G9SX-AD-□/G9SX-ADA-□).

## Accessories

### Terminal Block

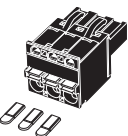
Appearance *	Specifications	Applicable units	Model	Remarks
	Terminal Block with screw terminals (3-pin)	G9SX-AD-□ G9SX-ADA-□	<b>Y9S-03T1B-02A</b>	Two Terminal Blocks (black) with screw terminals, and a set of six code marks to prevent erroneous insertion.
	Terminal Block with screw terminals (4-pin)	G9SX-BC-□ G9SX-EX-□	<b>Y9S-04T1B-02A</b>	Two Terminal Blocks (black) with screw terminals, and a set of six code marks to prevent erroneous insertion.
	Terminal Block with spring-cage terminals (3-pin)	G9SX-AD-□ G9SX-ADA-□	<b>Y9S-03C1B-02A</b>	Two Terminal Blocks (black) with spring-cage terminals, and a set of six code marks to prevent erroneous insertion.
	Terminal Block with spring-cage terminals (4-pin)	G9SX-BC-□ G9SX-EX-□	<b>Y9S-04C1B-02A</b>	Two Terminal Blocks (black) with spring-cage terminals, and a set of six code marks to prevent erroneous insertion.

**Note:** The G9SX main unit comes with a terminal block as standard equipment. The accessories shown here can be ordered as a replacement.

\* The illustrations show 3-pin types

## Specifications

### Ratings

#### Power input

Item	Model	G9SX-AD322-□/ADA222-□	G9SX-BC202-□	G9SX-EX-□
Rated supply voltage		24 VDC		
Operating voltage range		-15% to 10% of rated supply voltage		
Rated power consumption *		4 W max.	3 W max.	2 W max.

\* Power consumption of loads not included.

#### Inputs

Item	Model	G9SX-AD322-□/ADA222-□	G9SX-BC202-□
Safety input		20.4 VDC to 26.4 VDC, internal impedance: approx. 2.8 kΩ *	
Feedback/reset input			

\* Provide a current equal to or higher than that of the minimum applicable load of the connected input control device.

#### Outputs

Item	Model	G9SX-AD322-□/ADA222-□	G9SX-BC202-□
Instantaneous safety output *1 OFF-delayed safety output *1		P channel MOS-FET output Load current: 0.8 A DC max./output *2 *3	P channel MOS-FET output Load current: 0.8 A DC max./output *2 *3
Auxiliary output		PNP transistor output Load current: 100 mA max./output	

\*1. While safety outputs are in the ON state, the following signal sequence is output continuously for diagnosis. When using the safety outputs as input signals to control devices (i.e. Programmable Controllers), consider the OFF pulse shown below.

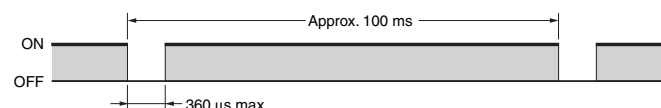

\*2. The following derating is required when Units are mounted side-by-side.

G9SX-AD322-□/G9SX-ADA222-□/G9SX-BC202-□: 0.4 A max. load current/output

\*3. A load current below 1 A DC/output can be used when the following outputs are used.

G9SX-AD322-□/G9SX-ADA222-□: 2 outputs or less

G9SX-BC202-□: 1 output

### Expansion Unit Ratings

Item	Model	G9SX-EX-□
Rated load		250 VAC, 3 A/30 VDC, 3 A (resistive load)
Rated carry current		3 A
Maximum switching voltage		250 VAC, 125 VDC

## Characteristics

Item	Model	G9SX-AD322-□/ADA222-□	G9SX-BC202-□	G9SX-EX-□
Overvoltage category (IEC/EN 60664-1)		II		II (Safety relay outputs 13 to 43 and 14 to 44: III)
Operating time (OFF to ON state) *1		50 ms max. (Safety input: ON) *2 100 ms max. (Logical AND connection input: ON) *3	50 ms max. (Safety input: ON)	30 ms max. *4
Response time (ON to OFF state) *1		15 ms max.		10 ms max. *4
Accuracy of OFF-delay time *5		Within ± 5% of the set value	---	Within ± 5% of the set value
Input	Input current	10 mA min.		---
	ON voltage	11 V min.		---
	OFF voltage	5 V min.		---
	OFF current	1 mA max.		---
	Maximum wiring length	100 m max. (External connection impedance: 100 Ω max. and 10 nF max.)		---
	Reset input time	100 ms min.		---
Output	ON-state residual voltage	3.0 V max. (safety output, auxiliary output)		
	OFF-state leakage current	0.1 mA max. (safety output, auxiliary output)		
Insulation resistance	Between logical AND connection terminals, and power supply input terminals and other input and output terminals connected together	20 MΩ min. (at 100 VDC)	---	---
	Between all terminals connected together and DIN track		20 MΩ min. (at 100 VDC)	100 MΩ min. (at 500 VDC)
Dielectric strength	Between logical AND connection terminals, and power supply input terminals and other input and output terminals connected together	500 VAC for 1 min	---	---
	Between all terminals connected together and DIN track		500 VAC for 1 min	1,200 VAC for 1 min
	Between different poles of outputs	---	---	2,200 VAC for 1 min
	Between safety relay outputs connected together and other terminals connected together	---	---	---
Vibration resistance		Frequency: 10 to 55 to 10 Hz, 0.375-mm single amplitude (0.75-mm double amplitude)		
Shock resistance	Destruction	300 m/s <sup>2</sup>		
	Malfunction	100 m/s <sup>2</sup>		
Durability	Electrical	---	100,000 cycles min. (rated load, switching frequency: 1,800 cycles/hour)	
	Mechanical	---	5,000,000 cycles min. (switching frequency: 7,200 cycles/hour)	
Ambient operating temperature		-10 to 55°C (with no icing or condensation)		
Ambient operating humidity		25% to 85%		
Terminal tightening torque *6		0.5 N·m		
Weight		Approx. 200 g	Approx. 125 g	Approx. 165 g

\*1. When two or more Units are connected by logical AND, the operating time and response time are the sum total of the operating times and response times, respectively, of all the Units connected by logical AND.

\*2. Represents the operating time when the safety input turns ON with all other conditions set.

\*3. Represents the operating time when the logical AND input turns ON with all other conditions set.

\*4. This does not include the operating time or response time of Advanced Units that are connected.

\*5. This does not include the operating time or response time of internal relays in the G9SX-EX-□.

\*6. For the G9SX-□-RT (with screw terminals) only.

## Logical AND Connection

Item	Model	G9SX-AD322-□/ADA222-□	G9SX-BC202-□	G9SX-EX-□
Number of Units connected per logical AND output		4 Units max.		---
Total number of Units connected by logical AND *1		20 Units max.		---
Number of Units connected in series by logical AND		5 Units max.		---
Max. number of Expansion Units connected *2		---		5 Units max.
Maximum cable length for logical AND input		100 m max./output		---

Note: See Logical AND Connection Combinations below for details.

\*1. The number of G9SX-EX401-□ Expansion Units or G9SX-EX041-T-□ Expansion Units (OFF-delayed Model) not included.

\*2. G9SX-EX401-□ Expansion Units and G9SX-EX041-T-□ Expansion Units (OFF-delayed Model) can be mixed.

### Logical AND Connection Combinations

- One logical AND connection output from an Advanced Unit G9SX-AD can be logical AND connected to up to four Advanced Units.

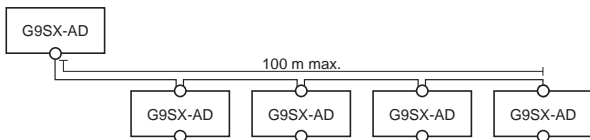

- Two logical AND outputs from a Basic Unit G9SX-BC can be logical AND connected to up to eight Advanced Units.

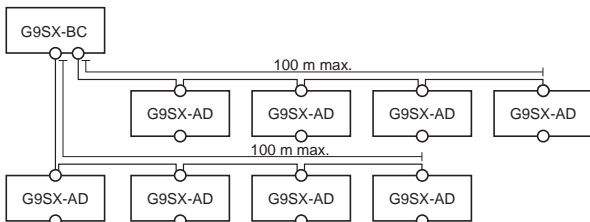

- Two logical AND outputs from an Advanced Unit G9SX-ADA can be logical AND connected to up to eight Advanced Units.

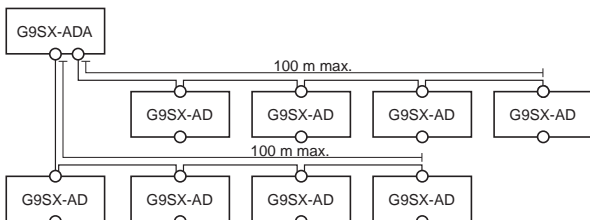

- Any Advanced Unit with logical AND input can be logical AND connected to Advanced Units on up to five tiers.

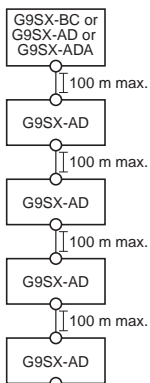

- Two logical AND connection outputs, each from different Advanced/Basic Units, can be logical AND connected to a single G9SX-ADA Unit.

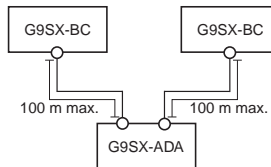

- The largest possible system configuration contains a total of 20 Advanced and Basic Units. In this configuration, each Advanced Unit can have up to five Expansion Units.

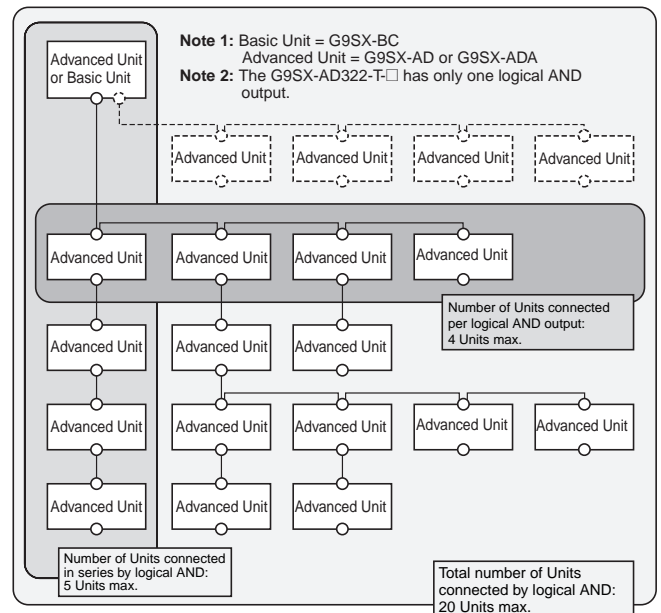



### Response Time and Operating Time

The following table shows the response time for two or more Units that are logical AND connected.

Tier	Item	Block flow diagram	Max. response time *1 (not including Expansion Units)	Max. response time *2 (including Expansion Units)	Max. operating time *3 (not including Expansion Units)	Max. operating time *4 (including Expansion Units)
First tier			15 ms	25 ms	50 ms	80 ms
Second tier			30 ms	40 ms	150 ms	180 ms
Third tier			45 ms	55 ms	250 ms	280 ms
Fourth tier			60 ms	70 ms	350 ms	380 ms
Fifth tier			75 ms	85 ms	450 ms	480 ms

- \*1. The maximum response time (not including Expansion Units) in this block flow diagram is the time it takes the output from the Unit on the lowest tier to switch from ON to OFF after the input to the Unit on the highest tier switches from ON to OFF.
- \*2. The maximum response time (including Expansion Units) in this block flow diagram is the time it takes the output from the Expansion Unit connected to the Unit on the lowest tier to switch from ON to OFF after the input to the Unit on the highest tier switches from ON to OFF.
- \*3. The maximum operating time (not including Expansion Units) in this block flow diagram is the time it takes the output from the Unit on the lowest tier to switch from OFF to ON after the input to the Unit on the highest tier switches from OFF to ON.
- \*4. The maximum operating time (including Expansion Units) in this block flow diagram is the time it takes the output from the Expansion Unit connected to the Unit on the lowest tier to switch from OFF to ON after the input to the Unit on the highest tier switches from OFF to ON.

## Connections

### Internal Connection

#### G9SX-AD322-□ (Advanced Unit)

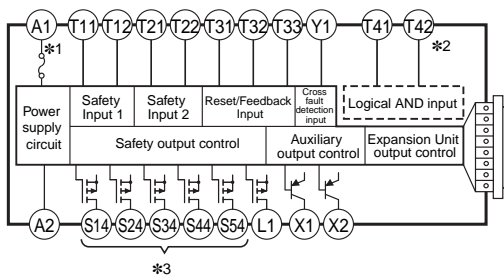

- \*1. Internal power supply circuit is not isolated.
- \*2. Logical AND input is isolated.
- \*3. Outputs S14 to S54 are internally redundant.

#### G9SX-BC202-□ (Basic Unit)

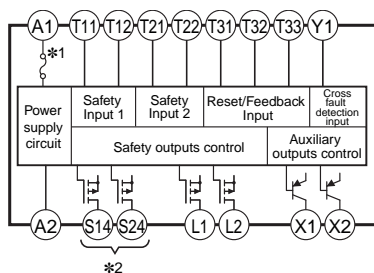

- \*1. Internal power supply circuit is not isolated.
- \*2. Outputs S14 and S24 are internally redundant.

#### G9SX-ADA222-□ (Advanced Unit)

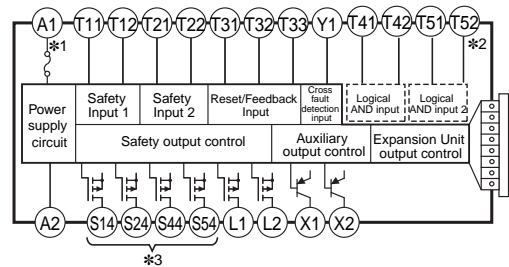

- \*1. Internal power supply circuit is not isolated.
- \*2. Logical AND inputs are isolated.
- \*3. Outputs S14 to S54 are internally redundant.

#### G9SX-EX401-□/G9SX-EX041-T-□ (Expansion Unit / Expansion Unit OFF-delayed model)

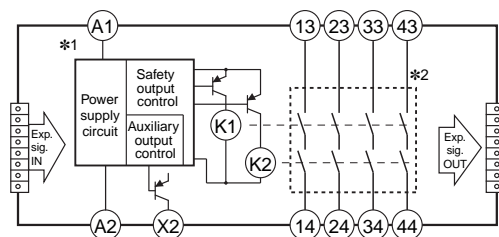

- \*1. Internal power supply circuit is not isolated.
- \*2. Relay outputs are isolated.



## Wiring of Inputs and Outputs

Signal name	Terminal name	Description of operation	Wiring
Power supply input	A1, A2	The input terminals for power supply. Connect the power source to the A1 and A2 terminals.	Connect the power supply plus (24 VDC) to the A1 terminal. Connect the power supply minus (GND) to the A2 terminal.
Safety input 1	T11, T12		Using 1 safety input channel 
Safety input 2	T21, T22	To set the safety outputs in the ON state, the ON state signals must be input to both safety input 1 and safety input 2. Otherwise the safety outputs cannot be in the ON state.	Using 2 safety input channels (cross fault detection OFF) 
			Using 2 safety input channels (cross fault detection ON) 
Feedback/reset input	T31, T32, T33	To set the safety outputs in the ON state, the ON state signal must be input to T33. Otherwise the safety outputs cannot be in the ON state.	Auto reset 
		To set the safety outputs in the ON state, the signal input to T32 must change from the OFF state to the ON state, and then to the OFF state. Otherwise the safety outputs cannot be in the ON state.	Manual reset 
Logical AND connection input	T41, T42, T51, T52	A logical AND connection means that one unit (Unit A) outputs a safety signal "a" to a subsequent unit (Unit B) and Unit B calculates the logical multiplication (AND) (i.e., outputs the AND) of the signal "a" and safety signal "b", which is input to Unit B. Thereby the logic of the safety output of Unit B is "a" AND "b". (An AND of inputs "a" and "b" is output.) To set the safety outputs of the subsequent Unit in the ON state, its logical AND connection preset switch must be set to AND (enable) and the HIGH state signal must be input to T41 of the subsequent unit.	
Cross fault detection input	Y1	Selects the mode for the failure detecting (cross fault detecting) function for the safety inputs of G9SX corresponding to the connection of the cross fault detection input.	Y1 connection varies depending on whether T11 and T21 are used or not. Refer to wiring of the safety input 1 and 2.
Instantaneous safety output	S14, S24, S34	Turns ON/OFF according to the state of the safety inputs, feedback/reset inputs, and logical AND connection inputs. During OFF-delay state, the Instantaneous safety outputs are not able to turn ON.	Keep these outputs open when not used.
OFF-delayed safety output	S44, S54	OFF-delayed safety outputs. The OFF-delay time is set by the OFF-delay preset switch. When the delay time is set to zero, these outputs can be used as instantaneous safety outputs.	Keep these outputs open when not used.
Logical AND connection output	L1, L2	Outputs a signal of the same logic as the instantaneous safety outputs.	Keep these outputs open when not used.
Auxiliary monitor output	X1	Outputs a signal of the same logic as the instantaneous safety outputs	Keep these outputs open when not used.
Auxiliary error output	X2	Outputs when the error indicator is lit or blinking.	Keep these outputs open when not used.

## Connecting Safety Sensors and the G9SX

- When connecting safety sensors to the G9SX, the Y1 terminal must be connected to 24 VDC. The G9SX will detect a connection error, if the Y1 terminal is open.
- In many cases, safety sensor outputs include an OFF-shot pulse for self diagnosis. The following condition of test pulse is applicable as safety inputs for the G9SX.
  - OFF-shot pulse width of the sensor, during the ON-state: 500 μs max.

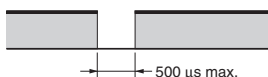

# Operation

## Functions

### Logical AND Connection

#### ● Example with G9SX-AD322-□

The logical AND connection means that the Basic Unit (or Advanced Unit) outputs a safety signal “a” to an Advanced Unit, and the Advanced Unit calculates the logical multiplication (AND) of the safety signal “a” and safety signal “b.” The safety output of an Advanced Unit with the logical AND connection shown in the following diagram is “a” AND “b”.

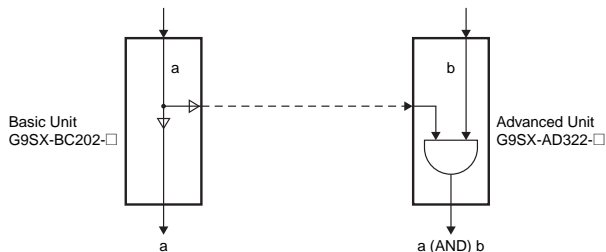

This is illustrated using the application in the following diagram as an example. The equipment here has two hazards identified as Robot 1 and Robot 2, and it is equipped with a safety door switch and an emergency stop switch. You may have overall control where both Robot 1 and Robot 2 are stopped every time the emergency stop switch is pressed. You may also have partial control where only Robot 1, which is closest to the door, is stopped when the door is opened. In that case, Robot 2 will continue to operate. The actual situation using a G9SX for this application is shown in this example.

(Note: The logical AND setting on the Advanced Unit must be set to AND (enabled).)

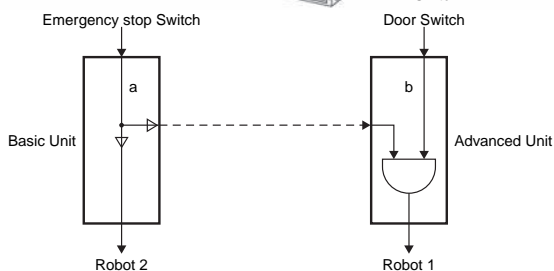
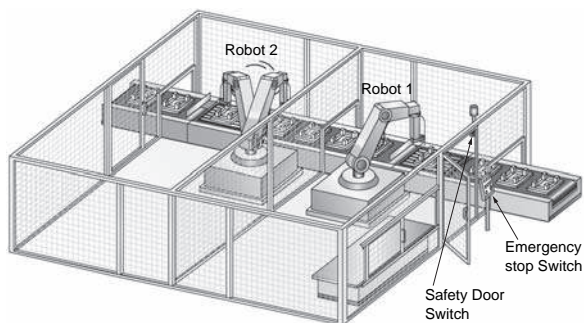

#### ● Example with G9SX-ADA222-□

The Advanced Unit G9SX-ADA222-□ is equipped with two logical AND connection inputs. Therefore, it is capable of receiving two safety signals, each from different Advanced or Basic Units. As shown in the diagram below, the output of Advanced Unit G9SX-ADA222-□ will be “a” AND “b” AND “c”.

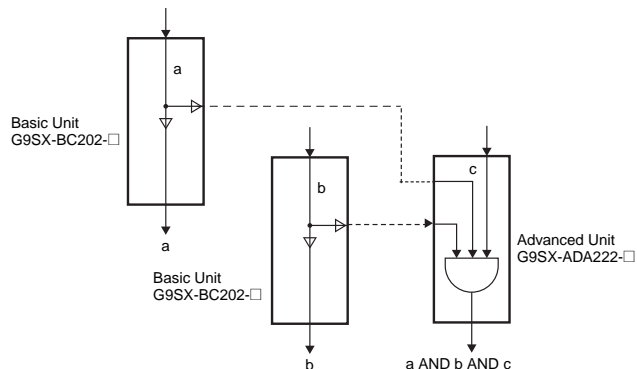

### Connecting Expansion Units

- The G9SX-EX and G9SX-EX-T Expansion Units can be connected to an Advanced Unit (G9SX-AD322-□/G9SX-ADA222-□) to increase the number of safety outputs. (They cannot be connected to a Basic Unit.)
- A maximum of five Expansion Units can be connected to one Advanced Unit. This may be a combination of G9SX-EX Instantaneous types and G9SX-EX-T OFF-delayed types.
- Remove the terminating connector from the receptacle on the Advanced Unit and insert the Expansion Unit cable connector into the receptacle. Insert the terminating connector into the receptacle on the Expansion Unit at the very end (rightmost).
- When Expansion Units are connected to an Advanced Unit, make sure that power is supplied to every Expansion Unit. (Refer to the following diagram for actual Expansion Unit connection.)

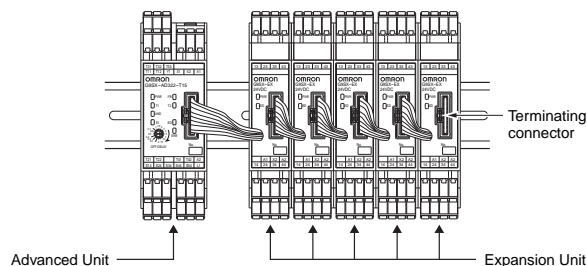

## Setting Procedure

### 1. Cross Fault Detection (Advanced Unit/Basic Unit)

Set the cross fault detection mode for safety inputs by shorting Y1 to 24 V or leaving it open. When cross fault detection is set to ON, short-circuit failures are detected between safety inputs T11-T12 and T21-T22. When a cross fault is detected, the following will occur.

1. The safety outputs and logical AND outputs lock out.
2. The LED error indicator is lit.
3. The error output (auxiliary output) turns ON.

Cross fault detection	Wiring	
OFF	Using 1 safety input channel	
	Using 2 safety input channels	
ON		

### 2. Reset Mode (Advanced Unit/Basic Unit)

Set the reset mode using feedback/reset input terminals T31, T32, and T33.

Auto reset mode is selected when terminal T32 is shorted to 24 V and manual reset mode is selected when terminal T33 is shorted to 24 V.

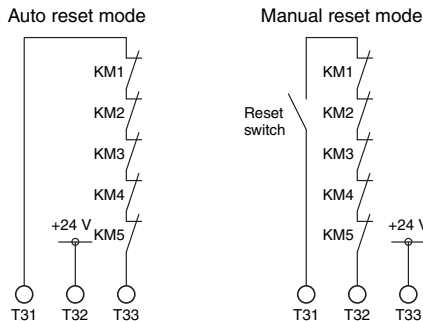

### 3. Setting Logical AND Connection (Advanced Unit)

When connecting two or more Advanced Units (or Basic Units) by logical AND connection, set the logical AND connection preset switch on the Advanced Unit that is on the input side (Advanced Unit G9SX-AD322 in the following diagram) to AND.

The default setting of the logical AND connection preset switch is set to OFF.

#### (1) Using G9SX-AD322 on the Input Side

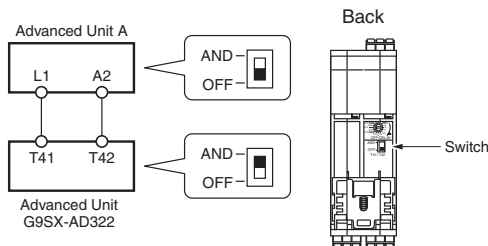

- Note:**
1. A setting error will occur and Advanced Unit G9SX-AD322 will lock out if the logical AND setting switch on the Unit is set to OFF.
  2. Set the logical AND setting switch on Advanced Unit A to OFF or an error will occur.
  3. A logical AND input cannot be sent to a Basic Unit.

#### (2) Using G9SX-ADA222 on the Input Side

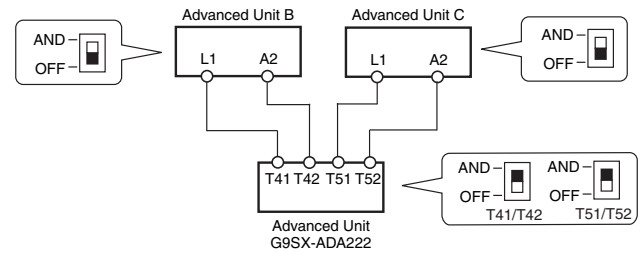

**Note:**

1. When not connecting Advanced Unit B, leave terminals T41 and T42 of the G9SX-ADA222 Advanced Unit open, and set the logical AND setting switch T41/T42 to OFF.
2. When not connecting Advanced Unit C, leave terminals T51 and T52 of the G9SX-ADA222 Advanced Unit open, and set the logical AND setting switch T51/T52 to OFF.

The following table shows the relationship between the logical ON setting switches and the conditions for safety outputs turning ON.

Logical AND connection preset switch		Conditions for safety outputs turning ON		
T41/T42	T51/T52	Safety input	Logic input 1	Logic input 2
OFF	OFF	ON	OFF	OFF
AND	OFF	ON	ON	OFF
OFF	AND	ON	OFF	ON
AND	AND	ON	ON	ON

### 4. Setting the OFF-delay Time (Advanced Unit)

The OFF-delay preset time on an Advanced Unit is set from the OFF-delay time preset switch (1 each on the front and back of the Unit).

Normal operation will only occur if both switches are identically set. An error will occur if the switches are not identically set.

The default setting of the OFF-delay time preset switch is set to 0 s.

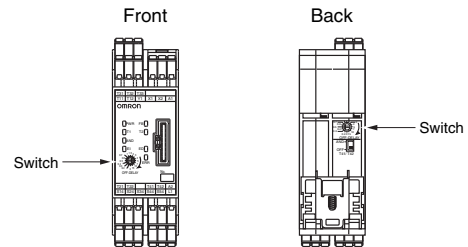

Refer to the following illustration for details on setting switch positions.

#### G9SX-AD322-T15/G9SX-ADA222-T15

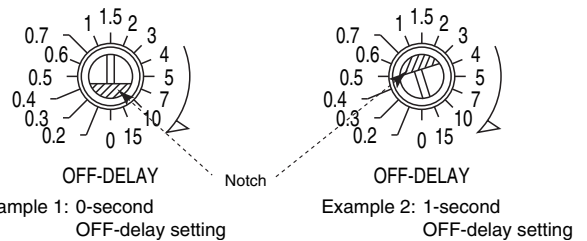

#### G9SX-AD322-T150/G9SX-ADA222-T150

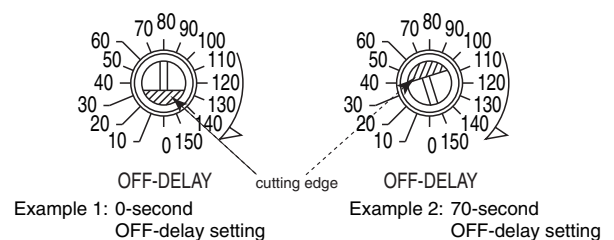

## LED Indicators

Marking	Color	Name	G9SX-AD	G9SX-ADA	G9SX-BC	G9SX-EX	G9SX-EX-T	Function	Reference
PWR	Green	Power supply indicator	○	○	○	○	○	Lights up while power is supplied.	---
T1	Orange	Safety input 1 indicator	○	○	○	---	---	Lights up while a HIGH state signal is input to T12. Blinks when an error relating to safety input 1 occurs.	
T2	Orange	Safety input 2 indicator	○	○	○	---	---	Lights up while a HIGH state signal is input to T22. Blinks when an error relating to safety input 2 occurs.	
FB	Orange	Feedback/reset input indicator	○	○	○	---	---	Lights up in the following cases: <ul style="list-style-type: none"> <li>With automatic reset while a HIGH state signal is input to T33.</li> <li>With manual reset while a HIGH state signal is input to T32.</li> </ul> Blinks when an error relating to feedback/reset input occurs.	
AND	Orange	Logical AND input indicator	○	---	---	---	---	Lights up while a HIGH state signal is input to T41. Blinks when an error relating to logical AND connection input occurs.	
AND1	Orange	Logical AND input indicator	---	○	---	---	---	Lights up while a HIGH state signal is input to T41. Blinks when an error relating to logical AND connection input occurs.	*
AND2	Orange	Logical AND input indicator	---	○	---	---	---	Lights up while a HIGH state signal is input to T51. Blinks when an error relating to logical AND connection input occurs.	
EI	Orange	Safety output indicator	○	○	○	○	---	Lights up while the Instantaneous safety outputs (S14, S24, S34) are in the ON-state. Blinks when an error relating to the instantaneous safety output occurs.	
ED	Orange	OFF-delayed safety output indicator	○	○	---	---	○	Lights up while OFF-delayed safety outputs (S44, S54) are in the ON-state. Blinks when an error relating to OFF-delayed safety output occurs.	
ERR	Red	Error indicator	○	○	○	○	○	Lights up or blinks when an error occurs.	

\* Refer to *Fault Detection* on the next page for details.

## Settings Indication (at Power ON)

Settings for the G9SX can be checked by the orange indicators for approx. 3 seconds after the power is turned ON. During this settings indication period, the ERR indicator will light, however the auxiliary error output will remain OFF









Indicator	Item	Setting position	Indicator status	Setting mode	Setting status
T1	Cross fault detection mode	Y1 terminal	Lit	Cross fault detection mode: ON	Y1 = open
			Not lit	Cross fault detection mode: OFF	Y1 = 24 VDC
FB	Reset mode	T32 or T33 terminal	Lit	Manual reset mode	T33 = 24 VDC
			Not lit	Auto reset mode	T32 = 24 VDC
AND (AND1, AND2)	Logical AND connection input mode	Logical AND connection preset switch	Lit	Enable logical AND input	"AND"
			Not lit	Disable logical AND input	"OFF"

## Fault Detection





When the G9SX detects a fault, the ERR indicator and/or other indicators light up or blink to inform the user about the fault.

Check and take necessary measures referring to the following table, and then re-supply power to the G9SX.

### (Advanced Unit/Basic Unit)

ERR indicator	Other indicator	Fault	Expected causes of the fault	Check points and measures to take			
 Blinks	---	Fault due to electro-magnetic disturbance or of internal circuits.	<ol style="list-style-type: none"> <li>Excessive electro-magnetic disturbance</li> <li>Failure of the internal circuit</li> </ol>	<ol style="list-style-type: none"> <li>Check the disturbance level around the G9SX and the related system.</li> <li>Replace with a new product.</li> </ol>			
 Lights up	 T1 blinks	Fault involved with safety input 1	<ol style="list-style-type: none"> <li>Failure involving the wiring of safety input 1</li> <li>Incorrect setting of cross fault detection input</li> <li>Failure of the circuit of safety input 1</li> </ol>	<ol style="list-style-type: none"> <li>Check the wiring to T11 and T12.</li> <li>Check the wiring to Y1.</li> <li>Replace with a new product.</li> </ol>			
	 T2 blinks	Fault involved with safety input 2	<ol style="list-style-type: none"> <li>Failure involving the wiring of safety input 2</li> <li>Incorrect setting of cross fault detection input</li> <li>Failure of circuits of safety input 2</li> </ol>	<ol style="list-style-type: none"> <li>Check the wiring to T21 and T22.</li> <li>Check the wiring to Y1.</li> <li>Replace with a new product.</li> </ol>			
	 FB blinks	Faults involved with feedback/reset input	<ol style="list-style-type: none"> <li>Failures involving the wiring of feedback/reset input.</li> <li>Failures of the circuit of feedback/reset input</li> </ol>	<ol style="list-style-type: none"> <li>Check the wiring to T31, T32 and T33.</li> <li>Replace with a new product.</li> </ol>			
			Fault in Expansion Unit	<ol style="list-style-type: none"> <li>Improper feedback signals from Expansion Unit</li> <li>Abnormal supply voltage to Expansion Unit</li> <li>Failure of the circuit of safety relay contact outputs</li> </ol>	<ol style="list-style-type: none"> <li>Check the connecting cable of Expansion Unit and the connection of the termination socket.</li> <li>Check the supply voltage to Expansion Unit. <b>Note:</b> Make sure that all Expansion units' PWR indicators are lit.</li> <li>Replace the Expansion Unit with a new one.</li> </ol>		
	 EI blinks	Fault involved with instantaneous safety outputs or logical AND connection outputs or auxiliary monitor output	<ol style="list-style-type: none"> <li>Failure involving the wiring of instantaneous safety outputs</li> <li>Failure of the circuit of Instantaneous safety outputs</li> <li>Failure involving the wiring of the logical AND connection output</li> <li>Failure of the circuit of the logical AND connection output</li> <li>Failure involving the wiring of the auxiliary monitor output</li> <li>Impermissible high ambient temperature</li> </ol>	<ol style="list-style-type: none"> <li>Check the wiring to S14, S24, and S34.</li> <li>Replace with a new product.</li> <li>Check the wiring to L1 and L2.</li> <li>Replace with a new product.</li> <li>Check the wiring to X1.</li> <li>Check the ambient temperature and spacing around the G9SX.</li> </ol>			
			 ED blinks	Fault involved with OFF-delayed safety outputs	<ol style="list-style-type: none"> <li>Failure involving the wiring of OFF-delayed safety relay contact outputs</li> <li>Incorrect set values for OFF-delay time</li> <li>Failure of the circuit of OFF-delayed safety relay contact outputs</li> <li>Impermissible high ambient temperature</li> </ol>	<ol style="list-style-type: none"> <li>Check the wiring to S44 and S54.</li> <li>Confirm the set values of the two OFF-delay time preset switches.</li> <li>Replace with a new product.</li> <li>Check the ambient temperature and spacing around the G9SX.</li> </ol>	
					 AND blinks (AND1, AND2)	Fault involved with logical AND connection input	<ol style="list-style-type: none"> <li>Failure involving the wiring of the logical AND connection input</li> <li>Incorrect setting for the logical AND connection input</li> <li>Failure of the circuit of the logical AND connection input</li> </ol>
 All indicators except PWR blink							Supply voltage outside the rated value

When indicators other than the ERR indicator blink, check and take necessary actions referring to the following table.

ERR indicator	Other indicators	Fault	Expected cause of the fault	Check points and measures to take			
 Off	<table border="1"> <tr> <td>T1</td> <td rowspan="2"></td> </tr> <tr> <td>T2</td> </tr> </table>	T1		T2	Mismatch between input 1 and input 2.	The input status between input 1 and input 2 is different, due to contact failure or a short circuit of safety input device(s) or a wiring fault.	Check the wiring from safety input devices to the G9SX. Or check the input sequence of safety input devices. After removing the fault, turn both safety inputs to the OFF state.
T1							
T2							

### (Expansion Unit)

ERR indicator	Other indicators	Fault	Expected cause of the faults	Check points and measures to take
 Lights	---	Fault involved with safety relay outputs of Expansion Units	<ol style="list-style-type: none"> <li>Welding of relay contacts</li> <li>Failure of the internal circuit</li> </ol>	Replace with a new product.

# Dimensions and Terminal Arrangement

## Advanced Unit

### G9SX-AD322-□

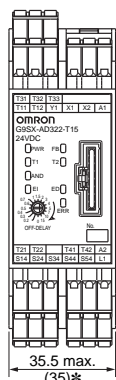
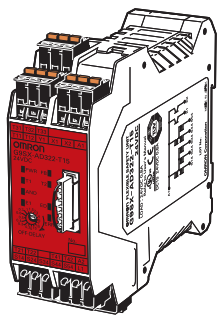

\* Typical dimension (35)\*

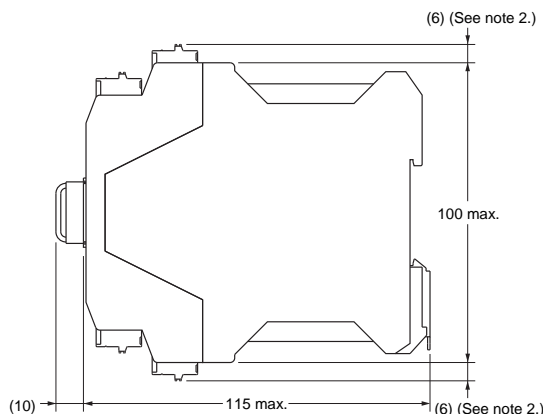

**Note:** 1. Above outline drawing is for -RC terminal type.  
2. For -RC terminal type only.

#### Terminal arrangement

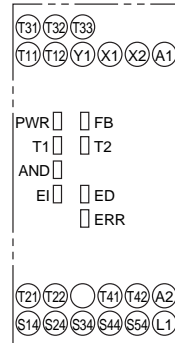

## Advanced Unit

### G9SX-ADA222-□

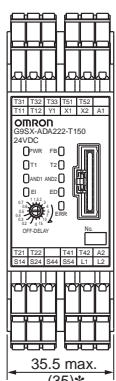
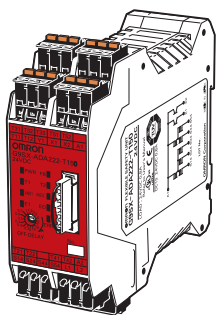

\* Typical dimension (35)\*

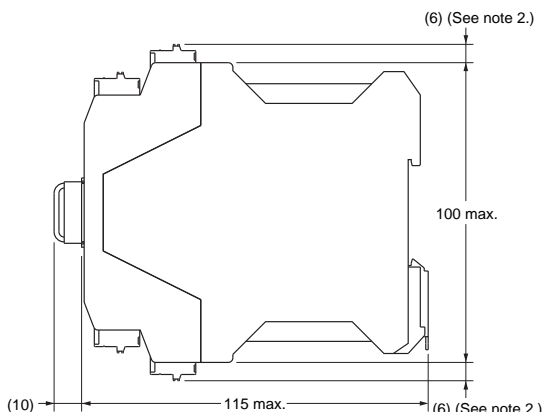

**Note:** 1. Above outline drawing is for -RC terminal type.  
2. For -RC terminal type only.

#### Terminal arrangement

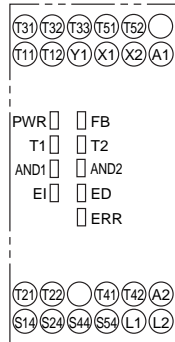

## Basic Unit

### G9SX-BC202-□

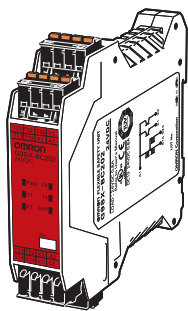

\* Typical dimension (22.5)\*

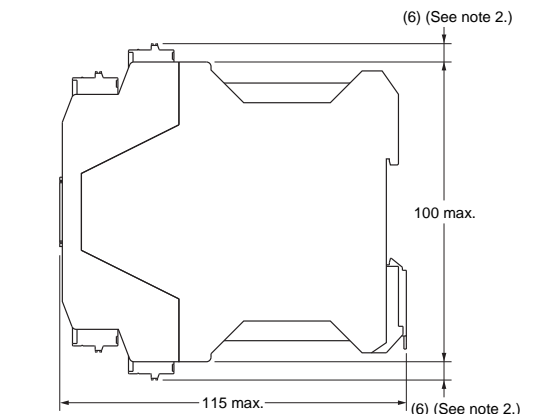

**Note:** 1. Above outline drawing is for -RC terminal type.  
2. For -RC terminal type only.

#### Terminal arrangement

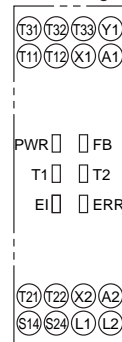





# Application Examples

PL/safety category	Model	Stop category	Reset
PLc/2 equivalent	Emergency Stop Switch A165E/A22E Flexible Safety Unit G9SX-AD322-T15	M1: 0 M2: 1	Manual

**Note:** The above PL is only the evaluation result of the example. The PL must be evaluated in an actual application by the customer after confirming the usage conditions.

## ● Application Overview

- The power supply to the motor M1 is turned OFF immediately when the emergency stop switch is pressed, and stop command is sent to the motor controller for the motor M2.
- The power supply to the motor M2 is turned OFF after OFF-delay time.
- The power supply to the motor M1 and M2 is kept OFF until the reset switch S2 is pressed while the emergency stop switch is released.

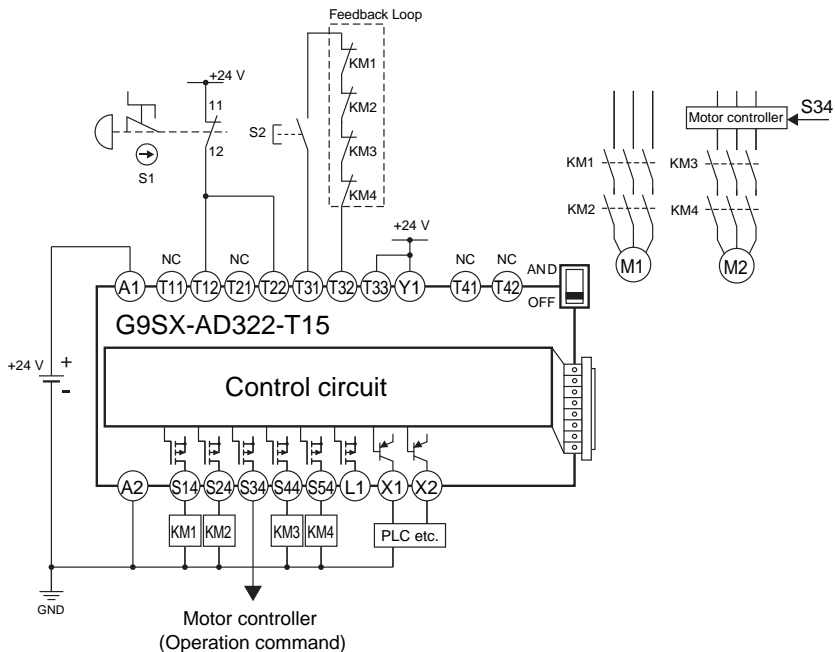

Timing chart

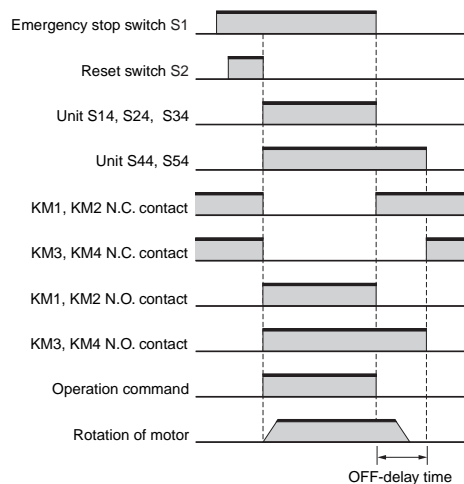

- S1: Emergency Stop Switch
- S2: Reset Switch S2
- KM1 to KM4: Contactor
- M1, M2: 3-phase motor

PL/safety category	Model	Stop category	Reset
PLe/4 equivalent	Safety Light Curtain F3SJ-A□□□□P□□ Flexible Safety Unit G9SX-AD322-T15	M1: 0 M2: 1	Auto

**Note:** The above PL is only the evaluation result of the example. The PL must be evaluated in an actual application by the customer after confirming the usage conditions.

**● Application Overview**

- The power supply to the motor M1 is turned OFF immediately when the beam is blocked, and stop command is sent to the motor controller for the motor M2.
- The power supply to the motor M2 is turned OFF after OFF-delay time.
- The power supply to the motor M1 and M2 is kept OFF until the beam is unblocked.

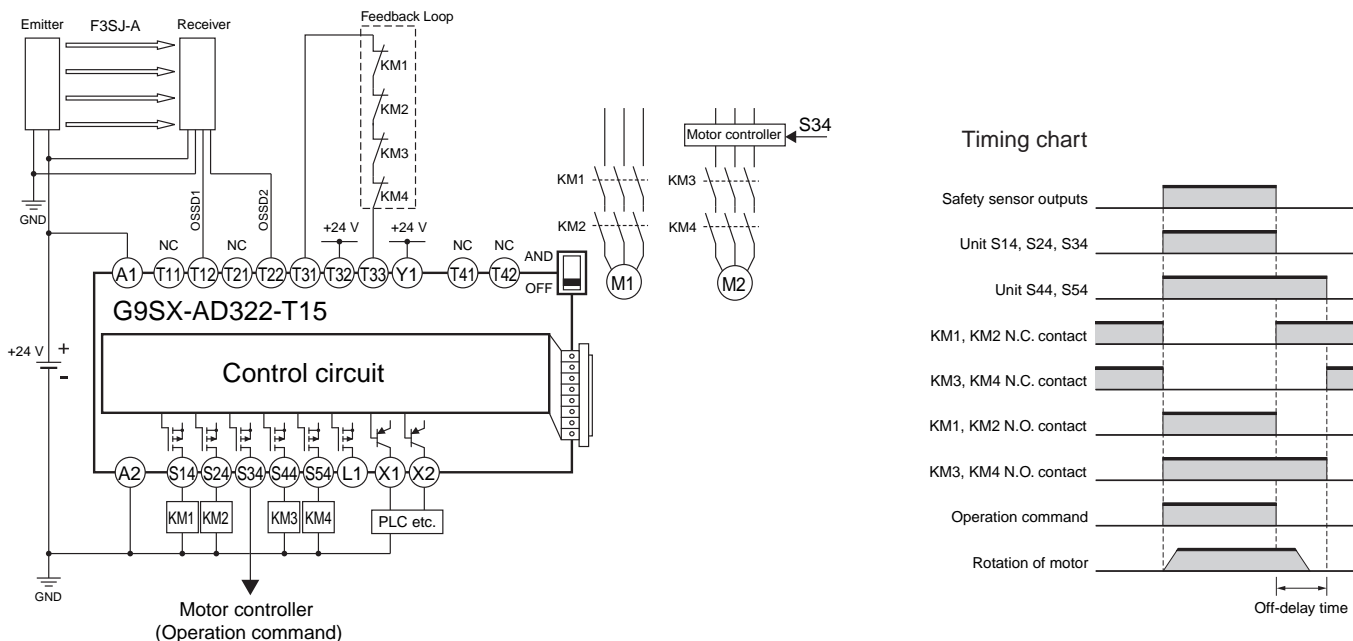

F3SJ-A: Safety sensor  
 KM1 to KM4: Contactor  
 M1, M2: 3-phase motor

- Note:**
1. For further information of settings and wiring, refer to the catalog or instruction manual of the connected sensor.
  2. Use safety sensors with PNP outputs.

PL/safety category	Model	Stop category	Reset
PLe/4 equivalent	Emergency Stop Switch A165E/A22 Flexible Safety Unit G9SX-BC202 Safety Limit Switch D4B-N/D4N/D4F Flexible Safety Unit G9SX-AD322-T15	M1, M2: 0 M3: 1	Emergency Stop: Manual Guard: Auto

**Note:** The above PL is only the evaluation result of the example. The PL must be evaluated in an actual application by the customer after confirming the usage conditions.

**● Application Overview**

- When the emergency stop switch S1 is pressed.
  - The power supply to the motor M1 and M2 is turned OFF immediately when the emergency stop switch S1 is pressed. Stop command is sent to the motor controller for the motor M3, and the power supply to the motor M3 is turned OFF after OFF-delay time.
  - The power supply to the motor M1 is kept OFF until the emergency stop switch S1 is released and the reset switch S2 is pressed.
  - The power supply to the motor M2 and M3 is kept OFF until the guard is closed and the reset switch S2 is pressed while the emergency stop switch S1 is released.
- When the guard is opened (the emergency stop switch S1 is released).
  - The power supply to the motor M2 is turned OFF immediately when the S3 and S4 detect that the guard is opened. Stop command is sent to the motor controller for the motor M3, and the power supply to the motor M3 is turned OFF after OFF-delay time. (The power supply to the motor M1 is kept ON.)
  - The power supply to the motor M2 and M3 is kept OFF until the guard is closed.

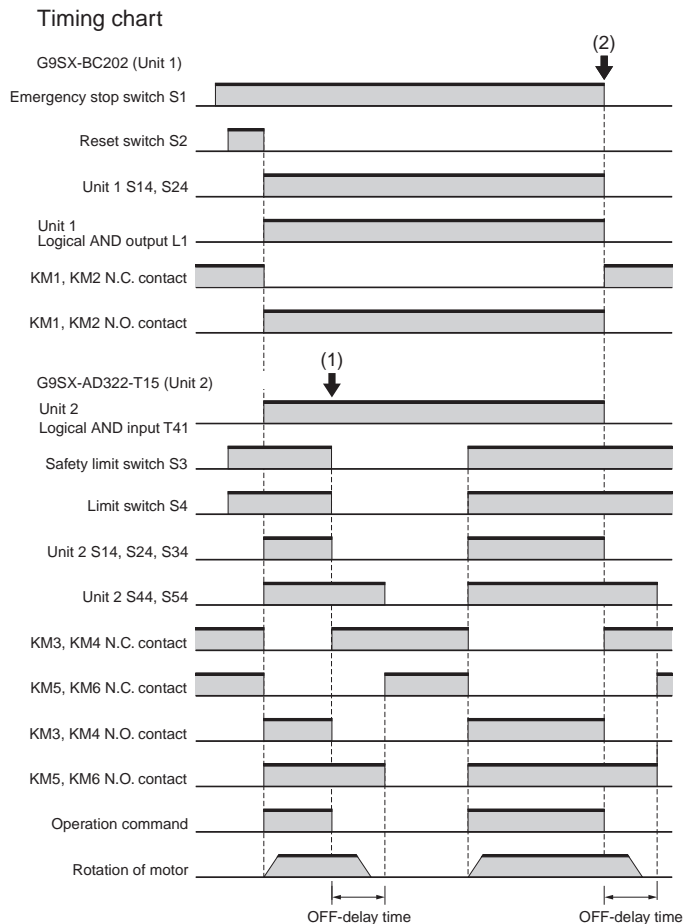
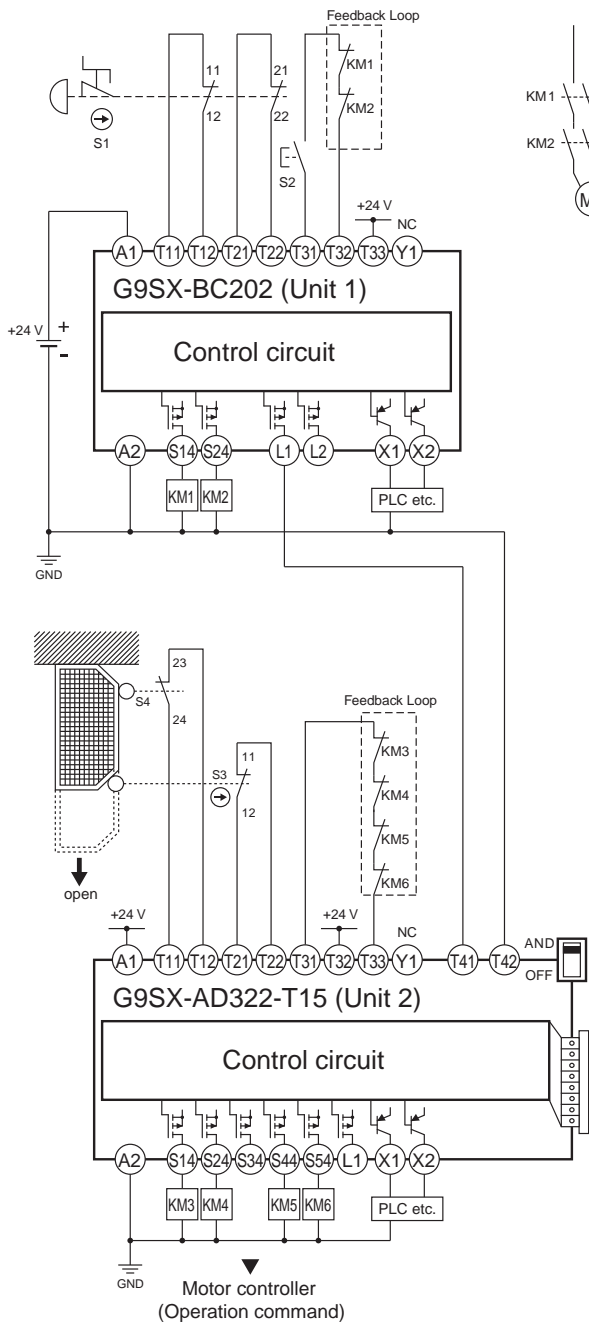

- (1) Guard opened: Only the Unit 2 stops.  
 (2) Emergency stop switch pressed: Both the Unit 1 and 2 stop.

PL/safety category	Model	Stop category	Reset
PLe/4 equivalent	Guard Lock Safety-door Switch D4NL Safety Limit Switch D4B-N/D4N/D4F Flexible Safety Unit G9SX-AD322-T15 + G9SX-EX041-T	M1: 0 M2, M3: 1	Manual

**Note:** The above PL is only the evaluation result of the example. The PL must be evaluated in an actual application by the customer after confirming the usage conditions.

**Application Overview**

- The power supply to the motor M1 is turned OFF immediately when the stop signal is input, and stop command is sent to the motor controller to decelerate the motor M2.
- The power supply to the motor M2 and M3 is turned OFF after OFF-delay time.
- When all the NC contacts of the KM1 to KM6 are closed and the lock release signal is input, the guard can be opened only while the lock release switch S4 is pressed.
- The power supply to the motor M1 to M3 is kept OFF until the reset switch S3 is pressed while the guard is closed and the lock release switch S4 is released.

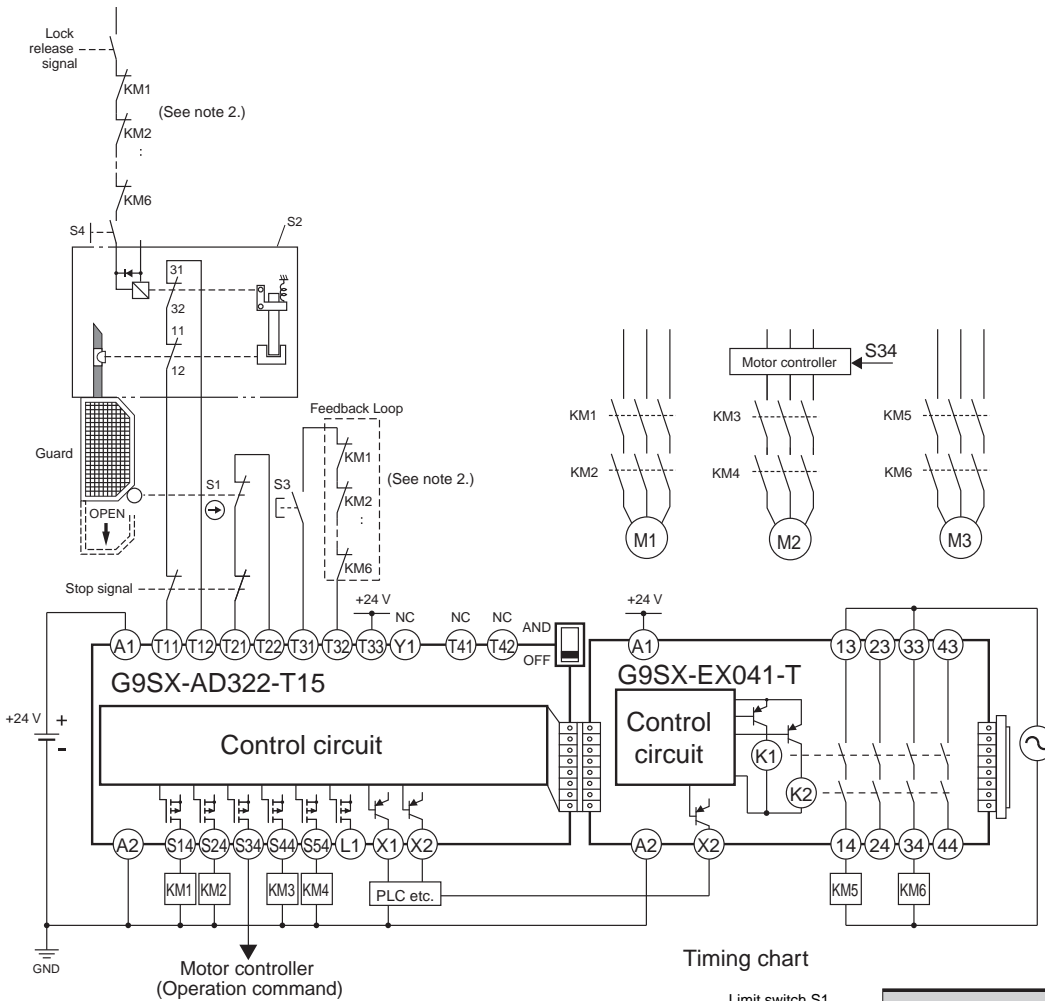

Timing chart

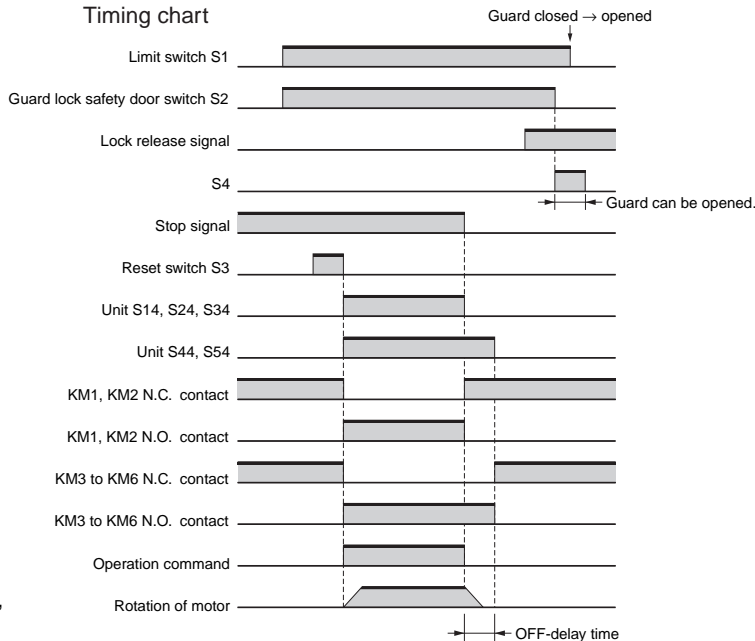

- S1: Safety limit switch
- S2: Guard lock safety door switch (Mechanical Lock)
- S3: Reset switch
- S4: Lock release switch
- KM1 to KM6: Contactor
- M1 to M3: 3-phase motor

**Note:** Connect the N.C. contacts of contactors KM1, KM2, KM3, KM4, KM5, and KM6 in series.

PL/safety category	Model	Stop category	Reset
PLe/4 equivalent	Emergency Stop Switch A165E/A22E Flexible Safety Unit G9SX-BC202 Safety Limit Switch D4B-N/D4N/D4F Flexible Safety Unit G9SX-AD322-T15 Flexible Safety Unit G9SX-ADA222-T150	M1, M2, M3: 0 M4: 1	Emergency Stop : Manual Guard 1, 2, 3: Auto

**Note:** The above PL is only the evaluation result of the example. The PL must be evaluated in an actual application by the customer after confirming the usage conditions.

### ● Application Overview

1. When the emergency stop switch S1 is pressed.
  - The power supply to the motor M1 to M3 is turned OFF immediately when the emergency stop switch S1 is pressed. Stop command is sent to the motor controller for the motor M4, and the power supply to the motor M4 is turned OFF after OFF-delay time.
  - The power supply to the motor M1 is kept OFF until the reset switch S2 is pressed while the emergency stop switch S1 is released.
  - The power supply to the motor M2 is kept OFF until the guard 1 is closed and the reset switch S2 is pressed while the emergency stop switch S1 is released.
  - The power supply to the motor M3 is kept OFF until the guard 2 is closed and the reset switch S2 is pressed while the emergency stop switch S1 is released.
  - The power supply to the motor M4 is kept OFF until the guard 1 to 3 are closed and the reset switch S2 is pressed while the emergency stop switch S1 is released.
2. When the guard 1 is opened (the emergency stop switch S1 is released).
  - The power supply to the motor M2 is turned OFF immediately when the S3 and S4 detect that the guard 1 is opened. Stop command is sent to the motor controller for the motor M4, and the power supply to the motor M4 is turned OFF after OFF-delay time.
  - The power supply to the motor M2 is kept OFF until the guard 1 is closed.
  - The power supply to the motor M4 is kept OFF until the guard 1 to 3 are closed.
3. When the guard 2 is opened (the emergency stop switch S1 is released).
  - The power supply to the motor M3 is turned OFF immediately when the S5 and S6 detect that the guard 2 is opened. Stop command is sent to the motor controller for the motor M4, and the power supply to the motor M4 is turned OFF after OFF-delay time.
  - The power supply to the motor M3 is kept OFF until the guard 2 is closed.
  - The power supply to the motor M4 is kept OFF until the guard 1 to 3 are closed.
4. When the guard 3 is opened (the emergency stop switch S1 is released).
  - When the S7 and S8 detect that the guard 3 is opened, stop command is sent to the motor controller for the motor M4 and the power supply to the motor M4 is turned OFF after OFF-delay time.
  - The power supply to the motor M4 is kept OFF until the guard 1 to 3 are closed.

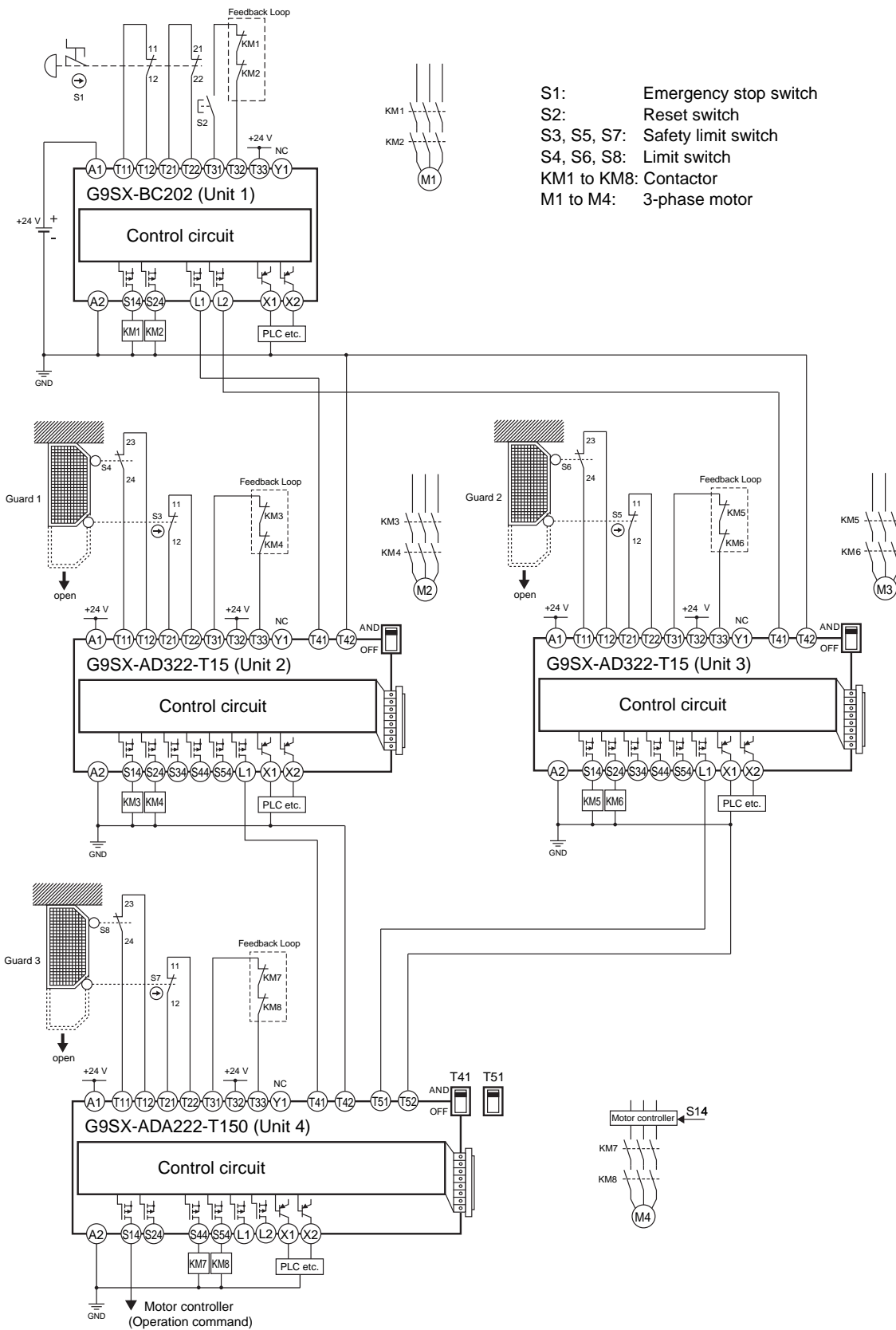

Timing chart

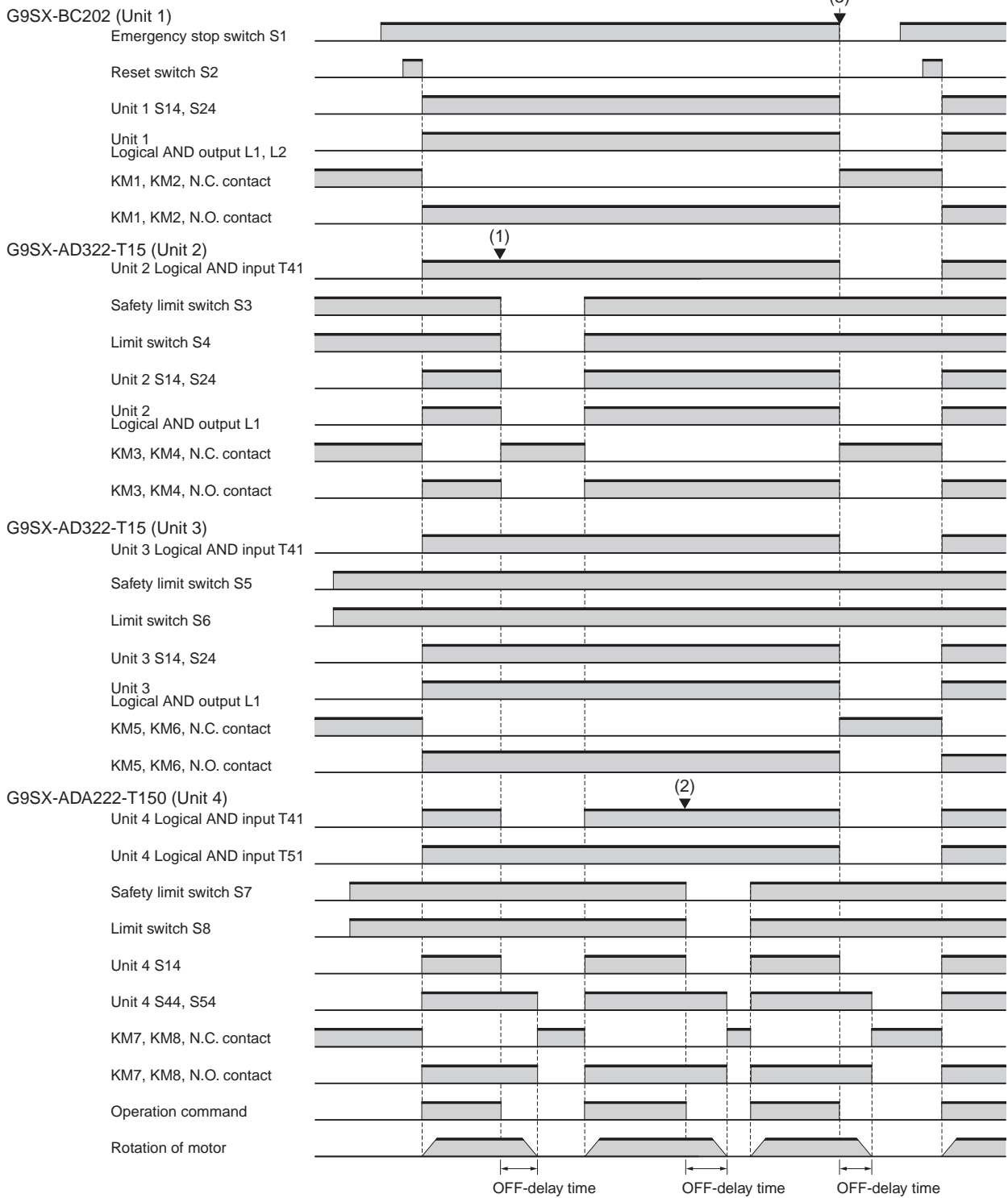

- (1) Guard 1 opened: Unit 2 and Unit 4 stop.
- (2) Guard 3 opened: Unit 4 stops.
- (3) Emergency stop switch pressed: All units stop.



# Safety Guard Switching Unit

# G9SX-GS

## A Safety Measure for Hazardous Operations That Does Not Lower Productivity



- Two functions support two types of application:
  - Auto switching: For applications where operators work together with machines
  - Manual switching: For applications with limited operations
- External indicator outputs enable indicating the switching status of two safety input devices.
- Auxiliary outputs enable monitoring of safety inputs, safety outputs, and errors.
- Detailed LED indications enable easy diagnosis.
- Logical AND connection allows complicated applications in combination with other G9SX-series Units.
- Certification for compliance with IEC/EN 61508 (SIL3), IEC/EN 62061 (SIL3) and EN ISO13849-1 (PLe/Safety Category 4).



 Be sure to read the "Safety Precautions" on page 47.

# Application Examples

## Auto Switching Function

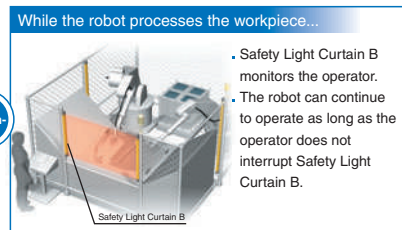
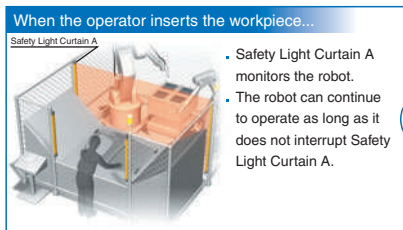

**Note:** If the operator is able to completely enter the zone inside Safety Light Curtain B, a presence detection device, such as a Safety Mat, is necessary as an additional safety measure.

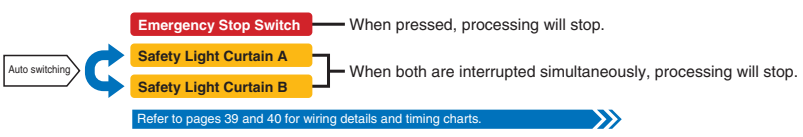
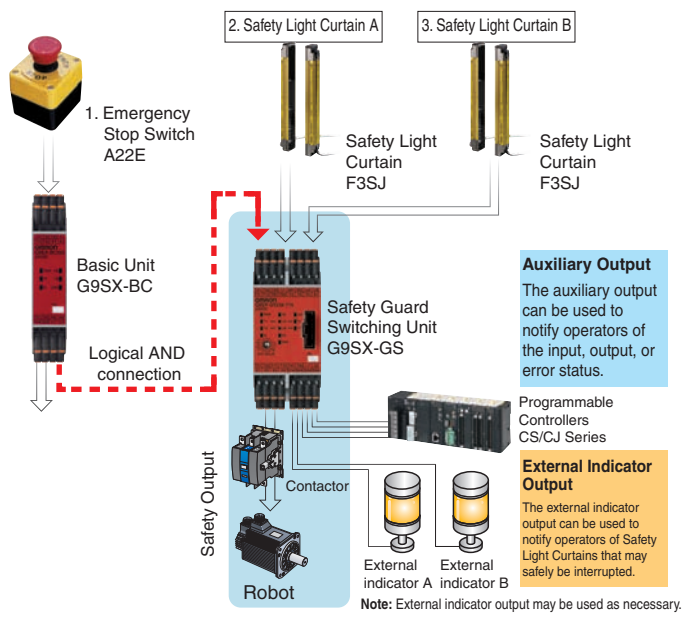
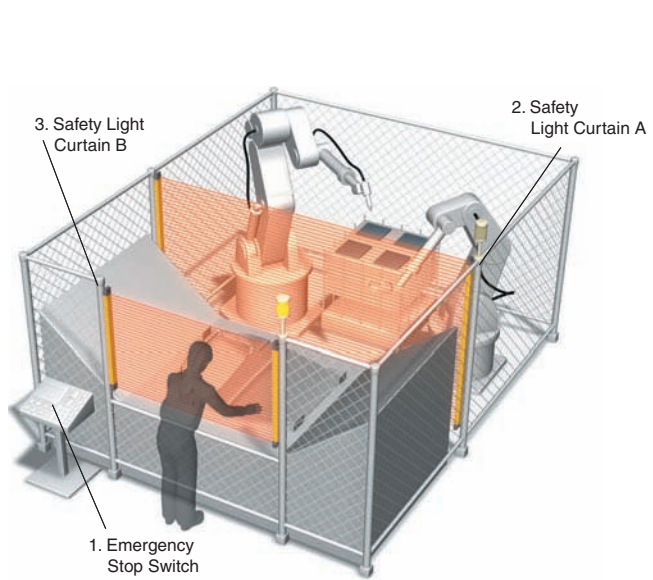

	Working condition	External indicator	G9SX-GS			
			Safety input	Safety output	Monitor output	External indicator
Normal operation	<p>1</p>	  OK to work	Safety input A: ON Safety input B: ON	Safety output: ON	Input A monitor: ON Input B monitor: ON	Indicator A: ON Indicator B: ON
	<p>2</p>	  OK to work	Safety input A: ON Safety input B: OFF	Safety output: ON	Input A monitor: ON Input B monitor: OFF	Indicator A: OFF Indicator B: ON
	<p>3</p>	  Not OK to work	Safety input A: OFF Safety input B: ON	Safety output: ON	Input A monitor: OFF Input B monitor: ON	Indicator A: ON Indicator B: OFF
Hazardous condition	<p>4</p>	  Not OK to work	Safety input A: OFF Safety input B: OFF	Safety output: OFF	Input A monitor: OFF Input B monitor: OFF	Indicator A: OFF Indicator B: OFF

# Manual Switching Function

**During normal operation...**

- The Door Switch monitors the opening and closing of the door during normal operation.
- The machine is able to operate while the door is closed.

Door Switch

**During maintenance...**

- The Limit Switch monitors the conveyor cart position during maintenance.
- The machine is able to operate while the conveyor cart is in a specified area.

Limit Switch

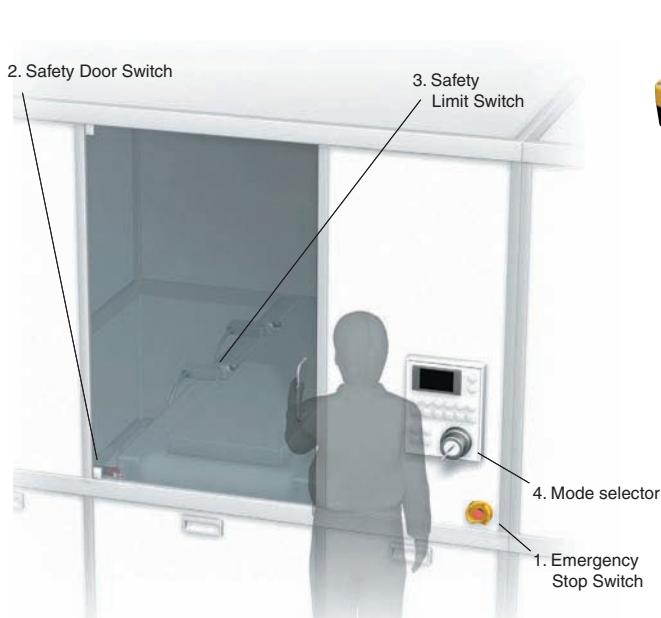

**Auxiliary Output**  
The auxiliary output can be used to notify operators of the input, output, or error status.

**External Indicator Output**  
The external indicator output can be used to notify operators that the cover may be opened.

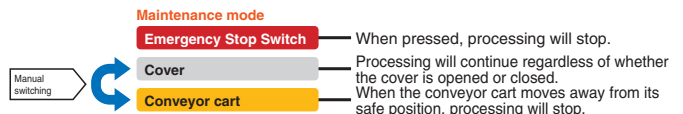
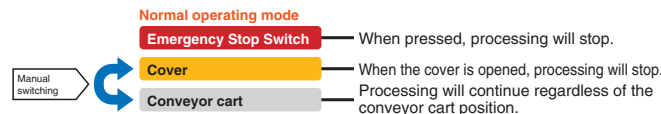

Refer to pages 41 to 43 for wiring details and timing charts.

	Working condition	External indicator	G9SX-GS				
			Safety input	Safety output	Mode selector	Monitor output	External indicator
Normal operation	1	Not OK to open OK to open	Safety input A <b>Dis-abled</b>	<b>ON</b> Safety output	Normal operating mode	<b>OFF</b> Input A monitor <b>ON</b> Input B monitor	Indicator A Indicator B
			Safety input A <b>ON</b>	<b>ON</b> Safety output	Maintenance mode	<b>ON</b> Input A monitor <b>OFF</b> Input B monitor	Indicator A Indicator B
Maintenance	2	Not OK to open OK to open	Safety input A <b>ON</b>	<b>ON</b> Safety output	Maintenance mode	<b>ON</b> Input A monitor <b>OFF</b> Input B monitor	Indicator A Indicator B
			Safety input B <b>Dis-abled</b>	<b>ON</b> Safety output	Maintenance mode	<b>ON</b> Input A monitor <b>OFF</b> Input B monitor	Indicator A Indicator B
Hazardous condition	3	Not OK to open OK to open	Safety input A <b>ON</b>	<b>ON</b> Safety output	Maintenance mode	<b>ON</b> Input A monitor <b>OFF</b> Input B monitor	Indicator A Indicator B
			Safety input B <b>Dis-abled</b>	<b>ON</b> Safety output	Maintenance mode	<b>ON</b> Input A monitor <b>OFF</b> Input B monitor	Indicator A Indicator B
Hazardous condition	4	Not OK to open OK to open	Safety input A <b>OFF</b>	<b>OFF</b> Safety output	Maintenance mode	<b>OFF</b> Input A monitor <b>OFF</b> Input B monitor	Indicator A Indicator B
			Safety input B <b>Dis-abled</b>	<b>OFF</b> Safety output	Maintenance mode	<b>OFF</b> Input A monitor <b>OFF</b> Input B monitor	Indicator A Indicator B

## Model Number Structure

### Model Number Legend

**Note:** Please see "Ordering Information" below for the actual models that can be ordered.

G9SX-□□□□□-□□□□-□□□  
 1 2 3 4 5 6

#### 1. Functions

GS: Safety Guard Switching Unit  
 EX: Expansion Unit

#### 2. Output Configuration (Instantaneous Safety Outputs)

0: None  
 2: 2 outputs  
 4: 4 outputs

#### 3. Output Configuration (OFF-delayed Safety Outputs)

0: None  
 2: 2 outputs  
 4: 4 outputs

#### 4. Output Configuration (Auxiliary Outputs)

1: 1 output  
 6: 6 outputs

#### 5. Max. OFF-delay Time

Safety Guard Switching Unit  
 T15: 15 s  
 Expansion Unit  
 No indicator: No OFF delay  
 T: OFF delay

#### 6. Terminal Block Type

RT: Screw terminals  
 RC: Spring-cage terminals

## Ordering Information

### List of Models

#### Safety Guard Switching Unit

Safety outputs *3		Auxiliary outputs *4	Logical AND connection		Max. OFF-delay time *1	Rated voltage	Terminal block type	Model
Instantaneous	OFF-delayed *2		Inputs	Outputs				
2 (semiconductor)	2 (semiconductor)	6 (semiconductor)	1 (semiconductor)	1 (semiconductor)	15 s	24 VDC	Screw terminals	G9SX-GS226-T15-RT
							Spring-cage terminals	G9SX-GS226-T15-RC

\*1. The OFF-delay time can be set in 16 steps as follows:

T15: 0, 0.2, 0.3, 0.4, 0.5, 0.6, 0.7, 1, 1.5, 2, 3, 4, 5, 7, 10, or 15 s

\*2. The OFF-delayed output becomes an instantaneous output by setting the OFF-delay time to 0 s.

\*3. P channel MOS-FET output

\*4. PNP transistor output (except for the external indicator outputs, which are P channel MOS-FET outputs)

#### Expansion Unit

Safety outputs		Auxiliary outputs *1	OFF-delay time	Rated voltage	Terminal block type	Model
Instantaneous	OFF-delayed					
4 PST-NO (contact)	---	1 (semiconductor)	---	24 VDC	Screw terminals	G9SX-EX401-RT
						Spring-cage terminals
---	4 PST-NO (contact)		*2		Screw terminals	G9SX-EX041-T-RT
					Spring-cage terminals	G9SX-EX041-T-RC

\*1. PNP transistor output

\*2. The OFF-delay time is synchronized to the OFF-delay time setting in the connected Unit (G9SX-GS226-T15-□).

### Accessories

#### Terminal Block

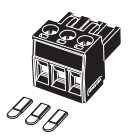
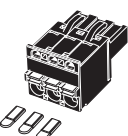
Appearance *	Specifications	Applicable units	Model	Remarks
	Terminal Block with screw terminals (4-pin)	G9SX-GS G9SX-EX-□	Y9S-04T1B-02A	Two Terminal Blocks (black) with screw terminals, and a set of six code marks to prevent erroneous insertion.
	Terminal Block with spring-cage terminals (4-pin)	G9SX-GS G9SX-EX-□	Y9S-04C1B-02A	Two Terminal Blocks (black) with spring-cage terminals, and a set of six code marks to prevent erroneous insertion.

**Note:** The G9SX main unit comes with a terminal block as standard equipment. The accessories shown here can be ordered as a replacement.

\* The illustrations show 3-pin types

## Specifications

### Ratings

#### Power Input

Item	Model	G9SX-GS226-T15-□	G9SX-EX-□
Rated supply voltage		24 VDC	
Operating voltage range		-15% to 10% of rated supply voltage	
Rated power consumption *		5 W max.	2 W max.

\* Power consumption of loads not included.

#### Inputs

Item	Model	G9SX-GS226-T15-□
Safety inputs		Operating voltage: 20.4 VDC to 26.4 VDC, Internal impedance: Approx. 2.8 kΩ *
Mode selector input		
Feedback/reset input		

\* Provide a current equal to or higher than that of the minimum applicable load of the connected input control device.

#### Outputs

Item	Model	G9SX-GS226-T15-□
Instantaneous safety outputs *1 OFF-delayed safety outputs *1		P channel MOS-FET outputs Load current: 0.8 A DC max./output *2
Auxiliary outputs (for input, output, and error monitoring)		PNP transistor outputs Load current: 0.8 A DC max./output *2
External indicator outputs		P channel MOS-FET outputs Connectable indicators <ul style="list-style-type: none"> <li>Incandescent lamp: 24 VDC, 3 to 7 W</li> <li>LED lamp: 10 to 300 mA DC/output</li> </ul>

\*1. While safety outputs are in the ON state, the following signal sequence is output continuously for diagnosis.

When using the safety outputs as input signals to control devices (i.e. Programmable Controllers), consider the OFF pulse shown below.

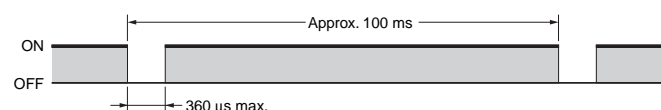

\*2. The following derating is required when Units are mounted side-by-side.

G9SX-GS226-T15-□: 0.4 A max. load current/output

#### Expansion Unit

Item	Model	G9SX-EX-□
Rated load		250 VAC, 3 A / 30 VDC, 3 A (resistive load)
Rated carry current		3 A
Maximum switching voltage		250 VAC, 125 VDC

## Characteristics

Item	Model	G9SX-GS226-T15-□	G9SX-EX-□
Overvoltage category (IEC/EN 60664-1)		II	II (Safety relay outputs 13 to 43 and 14 to 44: III)
Operating time (OFF to ON state) *1		50 ms max. (Safety input: ON) *2 100 ms max. (Logical AND connection input: ON) *3	30 ms max. *4
Response time (ON to OFF state) *1		15 ms max.	10 ms max. *4
Allowable switching time for mode selector input *5 *7		450 ms max.	---
Response time for switching operating modes *6 *7		50 ms max.	---
ON-state residual voltage		3.0 V max. for safety outputs, auxiliary outputs, and external indicator outputs	
OFF-state leakage current		0.1 mA max. for safety outputs and auxiliary outputs, 1 mA max. for external indicator outputs	
Maximum wiring length of safety input and logical AND input		100 m max. (External connection impedance: 100 Ω max. and 10 nF max.)	
Reset input time (Reset button pressing time)		100 ms min.	
Accuracy of OFF-delay time *8		Within ± 5% of the set value	
Insulation resistance	Between logical AND connection terminals, and power supply input terminals and other input and output terminals connected together	20 MΩ min. (at 100 VDC)	---
	Between all terminals connected together and DIN track		100 MΩ min. (at 500 VDC)
Dielectric strength	Between logical AND connection terminals, and power supply input terminals and other input and output terminals connected together	500 VAC for 1 min	---
	Between all terminals connected together and DIN track		1,200 VAC for 1 min
	Between different poles of outputs	---	2,200 VAC for 1 min
	Between safety relay outputs connected together and other terminals connected together		
Vibration resistance		Frequency: 10 to 55 to 10 Hz, 0.375-mm single amplitude (0.75-mm double amplitude)	
Shock resistance	Destruction	300 m/s <sup>2</sup>	
	Malfunction	100 m/s <sup>2</sup>	
Durability	Electrical	---	100,000 cycles min. (rated load, switching frequency: 1,800 cycles/hour)
	Mechanical	---	5,000,000 cycles min. (switching frequency: 7,200 cycles/hour)
Ambient operating temperature		-10 to 55°C (with no icing or condensation)	
Ambient operating humidity		25% to 85%	
Terminal tightening torque *9		0.5 N·m	
Weight		Approx. 240 g	Approx. 165 g

\*1. When two or more Units are connected by logical AND, the operating time and response time are the sum total of the operating times and response times, respectively, of all the Units connected by logical AND.

\*2. Represents the operating time when the safety input turns ON with all other conditions set.

\*3. Represents the operating time when the logical AND input turns ON with all other conditions set.

\*4. This does not include the operating time or response time of Safety Guard Switching Units that are connected.

\*5. This is the allowable switching time for the operating mode selector. If switching takes more than 450 ms, the G9SX-GS□ will detect an error.

\*6. This is the time required for the safety input to actually switch to an activated condition after the mode selector input is switched.

(When M2 turns ON after M1 turns OFF)

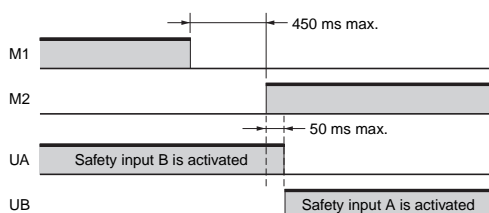

(When M1 turns OFF after M2 turns ON)

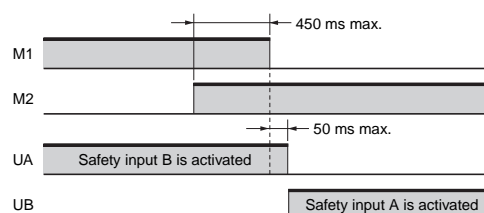

\*7. Only when the G9SX-GS□ is used with manual switching.

\*8. This does not include the operation time or response time of internal relays in the G9SX-EX-□.

\*9. For the G9SX-□-RT (with screw terminals) only.



**Logical AND Connection**

**Note:** Please see “Ordering Information” below for the actual models that can be ordered.

Item	Model	G9SX-GS226-T15-□	G9SX-EX-□
Number of Units connected per logical AND output		4 Units max.	---
Total number of Units connected by logical AND *1		20 Units max.	---
Number of Units connected in series by logical AND		5 Units max.	---
Max. number of Expansion Units connected *2		---	5 Units max.
Maximum cable length for logical AND input		100 m max.	---

\*1. The number of G9SX-EX401-□ Expansion Units or G9SX-EX041-T-□ Expansion Units (OFF-delayed Model) not included.

\*2. G9SX-EX401-□ Expansion Units and G9SX-EX041-T-□ Expansion Units (OFF-delayed Model) can be mixed.

**Connections**

**Internal Connection**

**G9SX-GS226-T15□ (Safety Guard Switching Unit)**

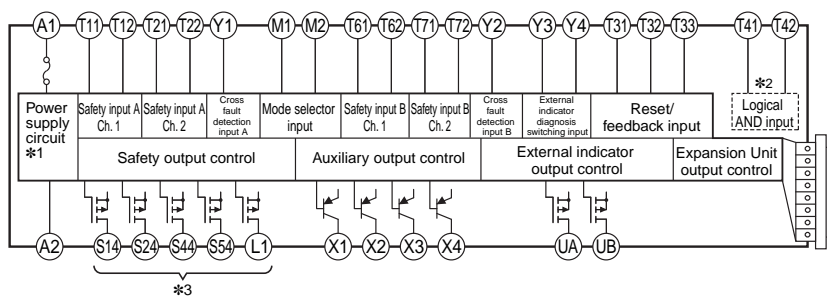

\*1. Internal power supply circuit is not isolated.

\*2. Logical AND input is isolated.

\*3. Outputs S14 to S54 and L1 are internally redundant.

**G9SX-EX401-□/G9SX-EX041-T-□**

**(Expansion Unit/Expansion Unit with OFF Delay)**

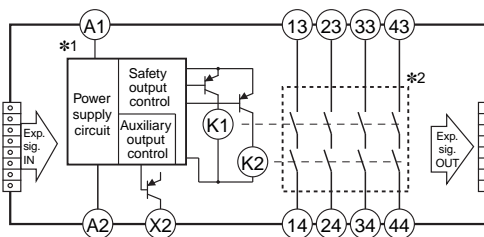

\*1. Internal power supply circuit is not isolated.

\*2. Relay outputs are isolated.



## Wiring of Inputs and Outputs

Signal name	Terminal name	Description of operation	Wiring
Power supply input	A1, A2	The power supply input terminals for the G9SX-GS□. Connect the power source to the A1 and A2 terminals.	Connect the power supply plus (24 VDC) to the A1 terminal. Connect the power supply minus (GND) to the A2 terminal.
Safety input A, channel 1	T11, T12	Using Auto Switching: For the safety output to go to the ON state, both channels 1 and 2 of safety input A must be in the ON state, channels 1 and 2 of safety input B must be in the ON state.	Using 1 safety input channel 
Safety input A, channel 2	T21, T22		Using 2 safety input channels (cross fault detection OFF) 
Safety input B, channel 1	T61, T62	Using Manual Switching: For the safety output to go to the ON state when safety input A is activated, both channels 1 and 2 of safety input A must be in the ON state (for maintenance mode). For the safety output to go to the ON state when safety input B is activated, both channels 1 and 2 of safety input B must be in the ON state (for normal operating mode).	Using 2 safety input channels (cross fault detection ON) 
Safety input B, channel 2	T71, T72		Using 1 safety input channel 
Feedback/reset input	T31, T32, T33	For the safety output to go to the ON state, the ON state signal must be input to T33. Otherwise the safety outputs cannot be in the ON state.	Auto reset 
		For the safety output to go to the ON state, the signal input to T32 must change from the OFF state to the ON state, and then to the OFF state. Otherwise the safety outputs cannot be in the ON state.	Manual reset 
Logical AND connection input	T41, T42	A logical AND connection means that one Unit (Unit A) outputs a safety signal "a" to a subsequent Unit (Unit B) and Unit B calculates the logical AND of "a" and safety signal "b." In the example shown at the right, the logical AND connection results in a safety output of "a AND b" for Unit B. Connect L1 of Unit A and T41 of Unit B to the power supply negative terminal (GND) of Unit A and T42 of Unit B. For the safety output to go to the ON state in the subsequent Unit, its logical AND connection preset switch must be set to AND (enabled) and the HIGH state signal must be input to T41 of the subsequent Unit.	
Mode selector input	M1, M2	When manual switching is selected, the SPST-NO/SPST-NC input enables the input of either safety input A or safety input B. The relationship of the safety input enable state and the mode selector input is as follows: M1 = ON, M2 = OFF: Safety input B is enabled (normal operating mode) M1 = OFF, M2 = ON: Safety input A is enabled (maintenance mode)	
Cross fault detection inputs	Y1, Y2	Selects the mode for the failure detecting (cross fault detecting) function for the safety inputs of G9SX-GS□ corresponding to the connection of the cross fault detection input.	Keep Y1 open when using T11 and T21 (wiring to enable cross fault detection). Keep Y2 open when using T61 and T71 (wiring to enable cross fault detection). Connect Y1 to 24 VDC when not using T11 and T21 (wiring to disable cross fault detection, or when connecting safety sensors). Connect Y2 to 24 VDC when not using T61 and T71 (wiring to disable cross fault detection, or when connecting safety sensors).
External indicator diagnosis switching inputs	Y3, Y4	Enables or disables error detection for the external indicator outputs of the G9SX-GS□.	Keep Y3 open when detecting errors for UA. Keep Y4 open when detecting errors for UB. Connect Y3 to 24 VDC when not detecting errors for UA. Connect Y4 to 24 VDC when not detecting errors for UB.

Signal name	Terminal name	Description of operation	Wiring
Instantaneous safety outputs	S14, S24	Turns ON/OFF according to the state of the safety inputs, feedback/reset input, and logical AND connection input. During OFF-delay state, the instantaneous safety outputs cannot turn ON.	Keep these outputs open when not used.
OFF-delayed safety outputs	S44, S54	OFF-delayed safety outputs. The OFF-delay time is set by the OFF-delay preset switch. When the delay time is set to zero, these outputs can be used as instantaneous safety outputs.	Keep these outputs open when not used.
Logical AND connection output	L1	Outputs a signal of the same logic as the instantaneous safety outputs.	Keep this output open when not used.
Auxiliary monitor output	X1	Outputs a signal of the same logic as the instantaneous safety outputs	Keep this output open when not used.
Auxiliary error output	X2	Outputs when the error indicator is lit or blinking.	Keep this output open when not used.
Auxiliary monitor outputs	X3, X4	X3 outputs a signal that is synchronized with and has the same logic as the input state of safety input A. X4 outputs a signal that is synchronized with and has the same logic as the input state of safety input B.	Keep these outputs open when not used.
External indicator outputs	UA, UB	Outputs the disabled state of the safety input. UA outputs a signal that is synchronized and has the same logic as the disabled state of safety input A. UB outputs a signal that is synchronized and has the same logic as the disabled state of safety input B.	Keep these outputs open when not used.

## Connecting Safety Sensors and G9SX-GS□

- To input the control output from safety sensors to the G9SX-GS□, the Y1 terminal must be connected to 24 VDC when the control output is connected to channel A. Likewise, the Y2 terminal must be connected to 24 VDC when the control output is connected to channel B. The G9SX-GS□ will detect a connection error if these terminals are not connected to 24 VDC.
- In many cases, safety sensor outputs include an OFF-shot pulse for self diagnosis.

The following condition of test pulse is applicable as safety inputs for the G9SX.

- OFF-shot pulse width of the sensor, during the ON-state: 500 μs max.

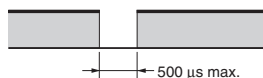

## Operation

### Functions

#### Auto Switching Function

The following table shows the relationship between the safety inputs and safety outputs of the G9SX-GS□ when auto switching is selected.

<b>Safety input A</b>	ON	ON	OFF	OFF
<b>Safety input B</b>	ON	OFF	ON	OFF
<b>Safety output</b>	ON	ON	ON	OFF

- Note:**
1. If the logical AND connection input is enabled, it must be ON as a necessary condition for the above table.
  2. Select either auto reset or manual reset for the reset mode, depending on the operation of the application.

#### Manual Switching Function

As shown in the following table, the relationship between the safety inputs and safety outputs of the G9SX-GS□ depends on the setting of the connected mode selector when manual switching is selected.

##### Mode Selector = Normal Operating Mode (M1 = ON, M2 = OFF)

<b>Safety input A</b>	ON	ON	OFF	OFF
<b>Safety input B</b>	ON	OFF	ON	OFF
<b>Safety output</b>	ON	OFF	ON	OFF

##### Mode Selector = Maintenance Mode (M1 = OFF, M2 = ON)

<b>Safety input A</b>	ON	ON	OFF	OFF
<b>Safety input B</b>	ON	OFF	ON	OFF
<b>Safety output</b>	ON	ON	OFF	OFF

- Note:**
1. If the logical AND connection input is enabled, it must be ON as a necessary condition for the above table.
  2. Select either auto reset or manual reset for the reset mode, depending on the operation of the application.

#### Logical AND Connection

The logical AND connection means that one Unit (Unit A) outputs a safety signal "a" to a subsequent Unit (Unit B) and Unit B calculates the logical AND between safety signal "a" and safety signal "b." In the example shown below, the logical AND connection results in a safety output of "a AND b" for Unit B.

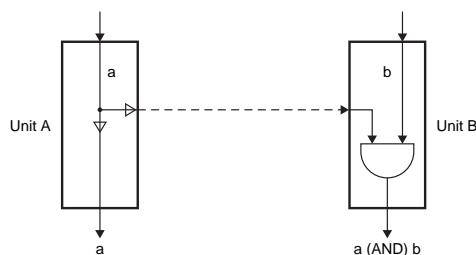

#### External Indicator Outputs

The operator can be notified of two safety input states (enabled/disabled) by connecting external indicator outputs UA and UB to indicators. External indicator outputs UA and UB turn ON when safety inputs A and B, respectively, are disabled, and turn OFF when safety inputs A and B, respectively, are enabled.

If error monitor output X2 turns ON, UA and UB will both turn OFF.

##### Auto Switching Selected

External indicator output	Description of operation	Output ON condition
<b>UA</b>	Safety input A is disabled.	Safety input B is ON.
<b>UB</b>	Safety input B is disabled.	Safety input A is ON.

##### Manual Switching Selected

External indicator output	Description of operation	Output ON condition
<b>UA</b>	Safety input A is disabled.	Mode selector switch must be set to normal operating mode.
<b>UB</b>	Safety input B is disabled.	Mode selector switch must be set to maintenance mode.

**Note:** Fault of external indicators can be detected. (Refer to page 34.)

#### Auxiliary Outputs

Auxiliary outputs X1 to X4 can be used to notify the operator of input, output, and error states, as shown in the following table.

Terminal name	Signal name	Output ON condition
<b>X1</b>	<b>Auxiliary monitor output</b>	X1 is ON when the instantaneous safety output is ON.
<b>X2</b>	<b>Auxiliary error output</b>	X2 is ON when the error LED is lit or flashing.
<b>X3</b>	<b>Input A monitor</b>	X3 is ON when safety input A is ON.
<b>X4</b>	<b>Input B monitor</b>	X4 is ON when safety input B is ON.

#### Connecting Expansion Units

- The G9SX-EX and G9SX-EX-T Expansion Units can be connected to the G9SX-GS226-T15-□ to increase the number of safety outputs.
- A maximum of five Expansion Units can be connected to one G9SX-GS226-T15-□. This may be a combination of the G9SX-EX Instantaneous Expansion Unit and the G9SX-EX-T OFF-delayed Expansion Unit.
- Remove the terminating connector from the receptacle on the G9SX-GS226-T15-□ and insert the Expansion Unit cable connector into the receptacle. Insert the terminating connector into the receptacle on the Expansion Unit at the very end (rightmost).
- When Expansion Units are connected to the G9SX-GS226-T15-□, make sure that power is supplied to every Expansion Unit. (Refer to the following diagram for actual Expansion Unit connections.)

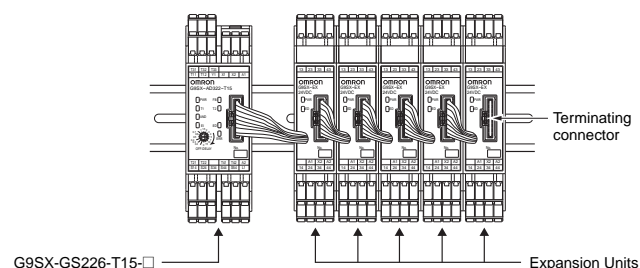

### Setting Procedure

#### 1. Switching Function

Auto or manual switching is set by using the Switching Function setting switch on the bottom of the G9SX-GS. Set the switch to *Auto* for auto switching and *Manual* for manual switching.

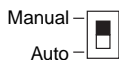

For manual switching, connect the mode selector as shown in the following table.

Switching function	Mode selector connection
Auto switching	
Manual switching	<p>M1 ON, M2 OFF: Normal operating mode M1 OFF, M2 ON: Maintenance mode</p>

#### 2. Reset Mode

Set the reset mode using feedback/reset input terminals T31, T32, and T33.

Auto reset mode is selected when terminal T32 is shorted to 24 V and manual reset mode is selected when terminal T33 is shorted to 24 V.

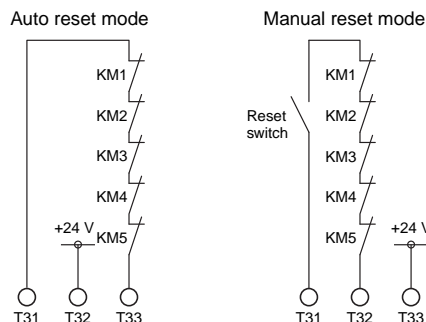

#### 3. Cross Fault Detection

When connecting a Door Switch or other safety input device, you can use Y1 or Y2 to switch the cross fault detection setting.

When Y1 is open, short-circuit failures are detected between safety inputs T11-T12 and T21-T22. When Y2 is open, short-circuit failures are detected between safety inputs T61-T62 and T71-T72. When a cross fault is detected, the following will occur.

1. The safety outputs and logical AND output will be locked out.
2. The LED error indicator will light.
3. The error output (auxiliary output) will turn ON.

When a safety sensor, such as a Safety Light Curtain, is connected to safety input A, connect Y1 to 24 V. When a safety sensor is connected to safety input B, connect Y2 to 24 V. If they are not connected to 24 V, the G9SX-GS will detect an error.

Cross fault detection	Equivalent safety category	Safety input A	Safety input B
OFF	Using 1 safety input channel		
	Using 2 safety input channels		
ON			

#### 4. Diagnostic Checks of External Indicators

Diagnostic checks of external indicators connected to external indicator outputs UA and UB can be switched with Y3 and Y4, respectively. Enabling the diagnostic check makes it possible to detect indicator burnout or wiring errors.

If there is no indicator connected to external indicator output UA, connect Y3 to 24 V. If there is no indicator connected to external indicator output UB, connect Y4 to 24 V. If they are not connected to 24 V, the G9SX-GS will detect an error.

External indicator output	Diagnostic check enabled	Diagnostic check disabled
UA		
UB		

**Note:** Diagnostic checks cannot be made for LED indicators. Disable the diagnostic check if using LED indicators.

#### 5. Setting Logical AND Connection

When connecting two or more Units using a logical AND connection, set the logical AND connection preset switch on the Unit that is on the input side to AND.

The default setting of the logical AND connection preset switch is set to OFF.

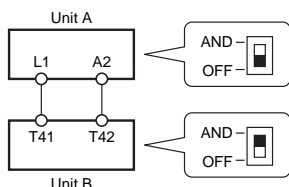

- Note:**
1. A setting error will occur and Unit B will lock out if the logical AND setting switch on Unit B is set to OFF.
  2. Set the logical AND setting switch on Unit A to OFF, otherwise the Unit A output will not turn ON.

#### 6. Setting the OFF-delay Time

The OFF-delay preset time is set from the OFF-delay time preset switch (1 each on the front and back of the Unit).

Normal operation will only occur if both switches are identically set. An error will occur if the switches are not identically set.

The default setting of the OFF-delay time preset switch is set to 0 s.

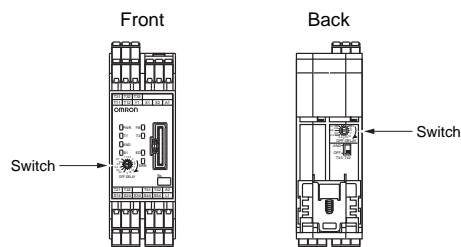

Refer to the following illustration for details on setting switch positions.  
G9SX-GS226-T15

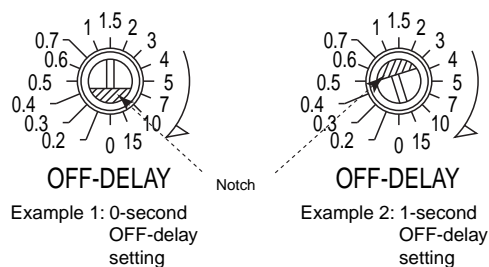

## LED Indicators

Marking	Color	Name	G9SX-GS	G9SX-EX	G9SX-EX-T	Function	Reference
PWR	Green	Power supply indicator	○	○	○	Lit while power is supplied.	
T1	Orange	Safety input A, channel 1 indicator	○	---	---	Lit while a HIGH state signal is input to T12. Blinks when an error relating to safety input A channel 1 occurs.	
T2	Orange	Safety input A, channel 2 indicator	○	---	---	Lit while a HIGH state signal is input to T22. Blinks when an error relating to safety input A channel 2 occurs.	
T6	Orange	Safety input B, channel 1 indicator	○	---	---	Lit while a HIGH state signal is input to T62. Blinks when an error relating to safety input B channel 1 occurs.	
T7	Orange	Safety input B, channel 2 indicator	○	---	---	Lit while a HIGH state signal is input to T72. Blinks when an error relating to safety input B channel 2 occurs.	
FB	Orange	Feedback/reset input indicator	○	---	---	Lit in the following cases: <ul style="list-style-type: none"> <li>With automatic reset while a HIGH state signal is input to T33.</li> <li>With manual reset while a HIGH state signal is input to T32.</li> </ul> Blinks when an error relating to feedback/reset input occurs.	*
AND	Orange	Logical AND input indicator	○	---	---	Lit while a HIGH state signal is input to T41. Blinks when an error relating to logical AND connection input occurs.	
EI	Orange	Safety output indicator	○	○	---	Lit while the Instantaneous safety outputs (S14, S24) are in the ON-state. Blinks when an error relating to the instantaneous safety output occurs.	
ED	Orange	OFF-delayed safety output indicator	○	---	○	Lit while OFF-delayed safety outputs (S44, S54) are in the ON-state. Blinks when an error relating to OFF-delayed safety output occurs.	
UA	Orange	Safety input A disabled state indicator	○	---	---	Lit while the input of safety input A (T12, T22) is disabled. Blinks when an error relating to the external indicator (UA) occurs.	
UB	Orange	Safety input B disabled state indicator	○	---	---	Lit while the input of safety input B (T62, T72) is disabled. Blinks when an error relating to the external indicator (UB) occurs.	
ERR	Red	Error indicator	○	○	○	Lights or blinks when an error occurs.	

\* Refer to "Fault Detection" on the next page for details.

## Settings Indication (at Power ON)









Settings for the G9SX-GS□ can be checked by the orange indicators for approx. 3 seconds after the power is turned ON. During this settings indication period, the ERR indicator will light, however the auxiliary error output will remain OFF

Indicator	Item	Setting position	Indicator status	Setting mode	Setting status
T1	Cross fault detection mode for safety input A	Y1 terminal	Lit	Enabled	Y1 = open
			Not lit	Disabled	Y1 = 24 VDC
T6	Cross fault detection mode for safety input B	Y2 terminal	Lit	Enabled	Y2 = open
			Not lit	Disabled	Y2 = 24 VDC
FB	Reset mode	T33 or T32 terminal	Lit	Manual reset mode	T33 = 24 VDC
			Not lit	Auto reset mode	T32 = 24 VDC
AND	Logical AND connection input mode	Logical AND connection preset switch	Lit	Enabled	"AND"
			Not lit	Disabled	"OFF"
UA, UB	Switching Function	Switching Function setting switch	Lit	Manual switching	"Manual"
			Not lit	Auto switching	"Auto"





## Fault Detection

When the G9SX-GS□ detects a fault, the ERR indicator and/or other indicators light or blink to inform the user about the fault. Check and take necessary measures referring to the following table, and then re-supply power to the G9SX-GS□.

### Safety Guard Switching Unit

ERR indicator	Other indicator	Fault	Expected causes of the fault	Check points and measures to take	
 Blinks	---	Fault due to electro-magnetic disturbance or of internal circuits.	<ol style="list-style-type: none"> <li>Excessive electromagnetic disturbance</li> <li>Failure of the internal circuit</li> </ol>	<ol style="list-style-type: none"> <li>Check the disturbance level around the G9SX-GS□ and the related system.</li> <li>Replace with a new product.</li> </ol>	
 Lights	 T1 blinks	Fault involved with safety input A, channel 1	<ol style="list-style-type: none"> <li>Failure involving the wiring of safety input A channel 1</li> <li>Incorrect setting of cross fault detection input</li> <li>Failure of the circuit of safety input A channel 1</li> </ol>	<ol style="list-style-type: none"> <li>Check the wiring to T11 and T12.</li> <li>Check the wiring to Y1.</li> <li>Replace with a new product.</li> </ol>	
	 T2 blinks	Fault involved with safety input A, channel 2	<ol style="list-style-type: none"> <li>Failure involving the wiring of safety input A channel 2</li> <li>Incorrect setting of cross fault detection input</li> <li>Failure of the circuit of safety input A channel 2</li> </ol>	<ol style="list-style-type: none"> <li>Check the wiring to T21 and T22.</li> <li>Check the wiring to Y1.</li> <li>Replace with a new product.</li> </ol>	
	 T6 blinks	Fault involved with safety input B, channel 1	<ol style="list-style-type: none"> <li>Failure involving the wiring of safety input B channel 1</li> <li>Incorrect setting of cross fault detection input</li> <li>Failure of the circuit of safety input B channel 1</li> </ol>	<ol style="list-style-type: none"> <li>Check the wiring to T61 and T62.</li> <li>Check the wiring to Y2.</li> <li>Replace with a new product.</li> </ol>	
	 T7 blinks	Fault involved with safety input B, channel 2	<ol style="list-style-type: none"> <li>Failure involving the wiring of safety input B channel 2</li> <li>Incorrect setting of cross fault detection input</li> <li>Failure of the circuit of safety input B channel 2</li> </ol>	<ol style="list-style-type: none"> <li>Check the wiring to T71 and T72.</li> <li>Check the wiring to Y2.</li> <li>Replace with a new product.</li> </ol>	
	 FB blinks		Faults involved with feedback/reset input	<ol style="list-style-type: none"> <li>Failures involving the wiring of feedback/reset input.</li> <li>Failures of the circuit of feedback/reset input</li> </ol>	<ol style="list-style-type: none"> <li>Check the wiring to T31, T32 and T33.</li> <li>Replace with a new product.</li> </ol>
			Fault in Expansion Unit	<ol style="list-style-type: none"> <li>Improper feedback signals from Expansion Unit</li> <li>Abnormal supply voltage to Expansion Unit</li> <li>Failure of the circuit of safety relay contact outputs</li> </ol>	<ol style="list-style-type: none"> <li>Check the connecting cable of Expansion Unit and the connection of the terminating connector</li> <li>Check the supply voltage to Expansion Unit. <b>Note:</b> Make sure that all Expansion units' PWR indicators are lit.</li> <li>Replace the Expansion Unit with a new one.</li> </ol>
	 EI blinks		Fault involved with instantaneous safety outputs or logical AND connection outputs	<ol style="list-style-type: none"> <li>Failure involving the wiring of instantaneous safety outputs</li> <li>Failure of the circuit of Instantaneous safety outputs</li> <li>Failure involving the wiring of the logical AND connection output</li> <li>Failure of the circuit of the logical AND connection output</li> <li>Impermissible high ambient temperature</li> </ol>	<ol style="list-style-type: none"> <li>Check the wiring to S14 and S24.</li> <li>Replace with a new product.</li> <li>Check the wiring to L1.</li> <li>Replace with a new product.</li> <li>Check the ambient temperature and spacing around the G9SX-GS□.</li> </ol>
	 ED blinks		Fault involved with OFF-delayed safety outputs	<ol style="list-style-type: none"> <li>Failure involving the wiring of OFF-delayed safety relay contact outputs</li> <li>Incorrect set values for OFF-delay time</li> <li>Failure of the circuit of OFF-delayed safety relay contact outputs</li> <li>Impermissible high ambient temperature</li> </ol>	<ol style="list-style-type: none"> <li>Check the wiring to S44 and S54.</li> <li>Confirm the set values of the OFF-delay time preset switches on the front and back of the Unit.</li> <li>Replace with a new product.</li> <li>Check the ambient temperature and spacing around the G9SX-GS□.</li> </ol>



ERR indicator	Other indicator	Fault	Expected causes of the fault	Check points and measures to take
● Lights	 AND blinks	Fault involved with logical AND connection input	1) Failure involving the wiring of the logical AND connection input 2) Incorrect setting for the logical AND connection input 3) Failure of the circuit of the logical AND connection input	1) Check the wiring to T41 and T42. <b>Note:</b> Make sure that the wiring length for the T41, T42 terminal is less than 100 meters. <b>Note:</b> Make sure that the logical AND connection signal is branched for less than 4 units. 2) Confirm the set value of the logical AND connection preset switch. 3) Replace with a new product.
	 UA blinks	Fault involved with the external indicator output (UA)	1) Failure involving the wiring of the external indicator output 2) Failure involving the wiring of the external indicator diagnosis switching input 3) Failure of the circuit of the external indicator output 4) Failure of the external indicator	1) Check the wiring to UA. 2) Check the wiring to Y3. <b>Note:</b> When no indicator is connected, or an LED indicator is connected, connect Y3 to 24 V. 3) Replace with a new product. 4) Replace the connected external indicator.
	 UB blinks	Fault involved with the external indicator output (UB)	1) Failure involving the wiring of the external indicator output 2) Failure involving the wiring of the external indicator diagnosis switching input 3) Failure of the circuit of the external indicator output 4) Failure of the external indicator	1) Check the wiring to UB. 2) Check the wiring to Y4. <b>Note:</b> When no indicator is connected, or an LED indicator is connected, connect Y4 to 24 V. 3) Replace with a new product. 4) Replace the connected external indicator.
	 UA and UB alternately blink	Fault involved with the Switching Function	1) Failure involving the setting of the Switching Function setting switch 2) Failure involving the wiring of the mode selector input 3) Failure involving the circuit of the mode selector input 4) Failure involving the mode selector switching time	1) Check the setting of the Switching Function setting switch. 2) Check the wiring to M1 and M2. 3) Replace with a new product. 4) Check the signal switching time of the mode selector input (M1, M2).
	 All indicators except PWR blink	Supply voltage outside the rated value	1) Supply voltage outside the rated value	1) Check the supply voltage to the Units.

When indicators other than the ERR indicator blink, check and take necessary actions referring to the following table.

ERR indicator	Other indicators	Fault	Expected cause of the fault	Check points and measures to take
○ Off	T1	Safety input A mismatch	The input status between safety input A channel 1 and safety input A channel 2 is different, due to contact failure or a short circuit of safety input device(s) or a wiring fault.	Check the wiring from safety input devices to the G9SX-GS□. Or check the input sequence of safety input devices. After removing the fault, turn both safety input A channels 1 and 2 to the OFF state.
	T2			
	T6	Safety input B mismatch	The input status between safety input B channel 1 and safety input B channel 2 is different, due to contact failure or a short circuit of safety input device(s) or a wiring fault.	Check the wiring from safety input devices to the G9SX-GS□. Or check the input sequence of safety input devices. After removing the fault, turn both safety input B channels 1 and 2 to the OFF state.
	T7			

#### (Expansion Unit)

ERR indicator	Other indicators	Fault	Expected cause of the faults	Check points and measures to take
● Lights	---	Fault involved with safety relay outputs of Expansion Units	1) Welding of relay contacts 2) Failure of the internal circuit	Replace with a new product.

# Dimensions and Terminal Arrangement

## Safety Guard Switching Unit

G9SX-GS226-T15-□

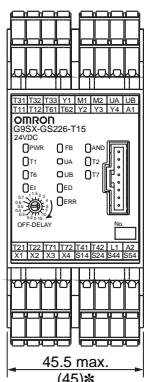
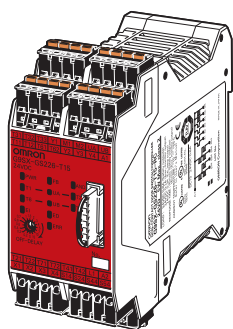

\* Typical dimension

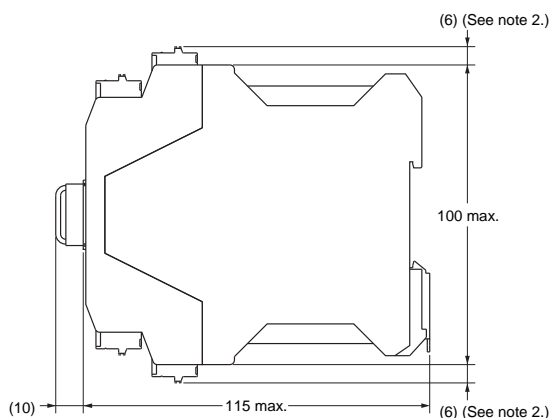

Terminal arrangement

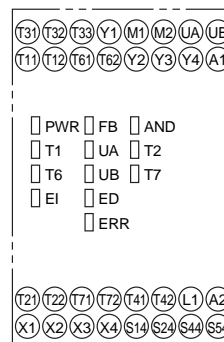

**Note: 1.** Above outline drawing is for -RC terminal type.  
**2.** For -RC terminal type only.

## Expansion Unit

G9SX-EX401-□

### Expansion Unit (OFF-delayed Model)

G9SX-EX041-T-□

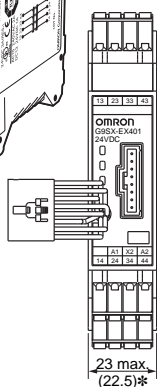
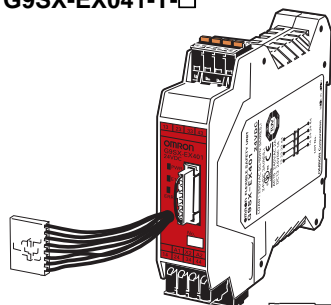

\* Typical dimension

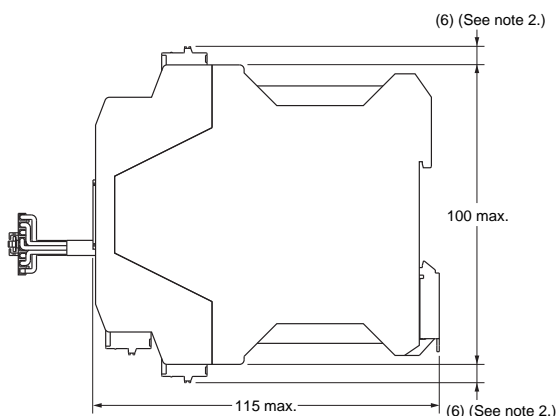

Terminal arrangement

G9SX-EX401-□  
(Expansion Unit)

G9SX-EX041-T-□  
(Expansion Unit with OFF Delay)

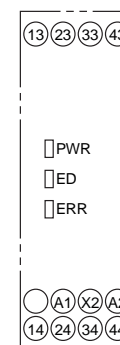
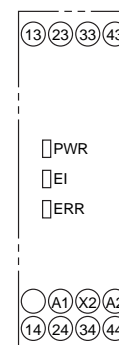

**Note: 1.** Above outline drawing is for -RC terminal type.  
**2.** For -RC terminal type only.

# Application Examples

PL/safety category	Model	Stop category	Reset
PLe/4 equivalent	Emergency Stop Switch A165E/A22E Flexible Safety Unit G9SX-BC202 Safety Light Curtain F3SJ-B/F3SJ-E/F3SJ-A Flexible Safety Unit G9SX-GS226-T15	M1, M2: 0	Emergency Stop: Manual Safety sensor: Auto

**Note:** The above PL is only the evaluation result of the example. The PL must be evaluated in an actual application by the customer after confirming the usage conditions.

## ● Application Overview

- When the emergency stop switch S1 is pressed.
  - The power supply to the motor M1 and M2 is turned OFF immediately when the emergency stop switch S1 is pressed.
  - The power supply to the motor M1 is kept OFF until the reset switch S2 is pressed while the emergency stop switch S1 is released.
  - The power supply to the motor M2 is kept OFF until one of the safety sensors 1 and 2 is unblocked and the reset switch S2 is pressed while the emergency stop switch S1 is released.
- When the operator and robot block the beams at the same time.
  - The power supply to the motor M2 is turned OFF immediately when both beams are blocked. (The power supply to the motor M1 is kept ON.)
  - The power supply to the motor M2 is kept OFF until one of the safety sensors 1 and 2 is unblocked.

- Note:**
- Diagnostic checks of the external indicators connected to external indicator outputs UA and UB can be switched with Y3 and Y4, respectively.
  - Use safety sensors with PNP outputs.

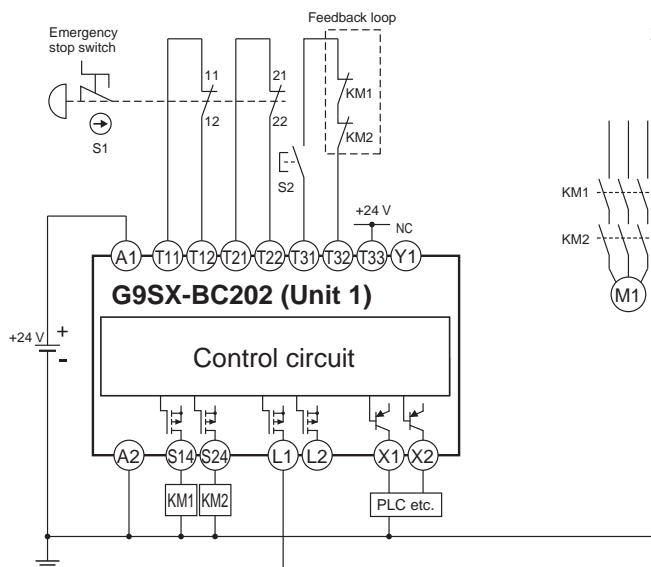

## Application Examples

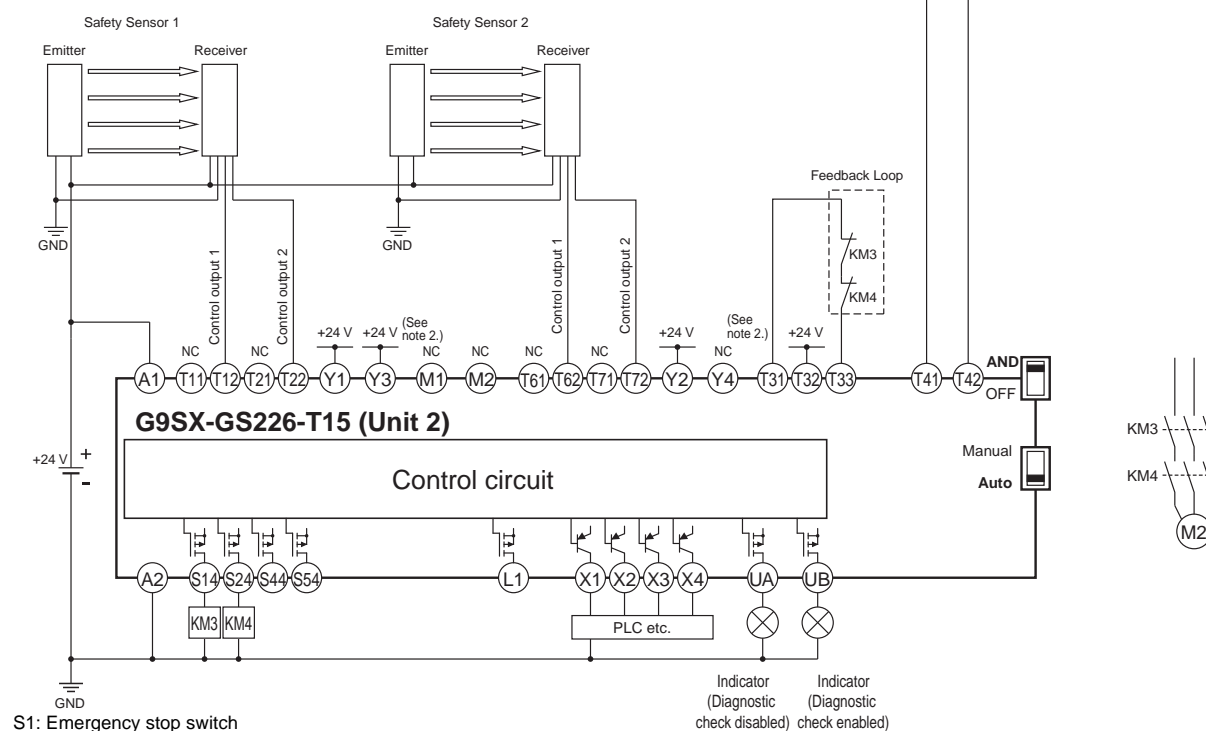
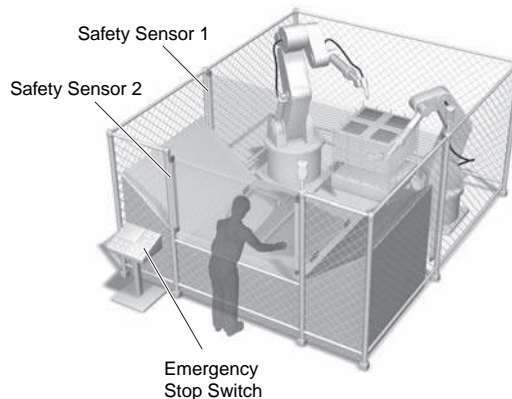

- S1: Emergency stop switch
- S2: Reset switch
- KM1 to KM4: Contactors
- M1 and M2: 3-phase motors

**Timing Chart 1**

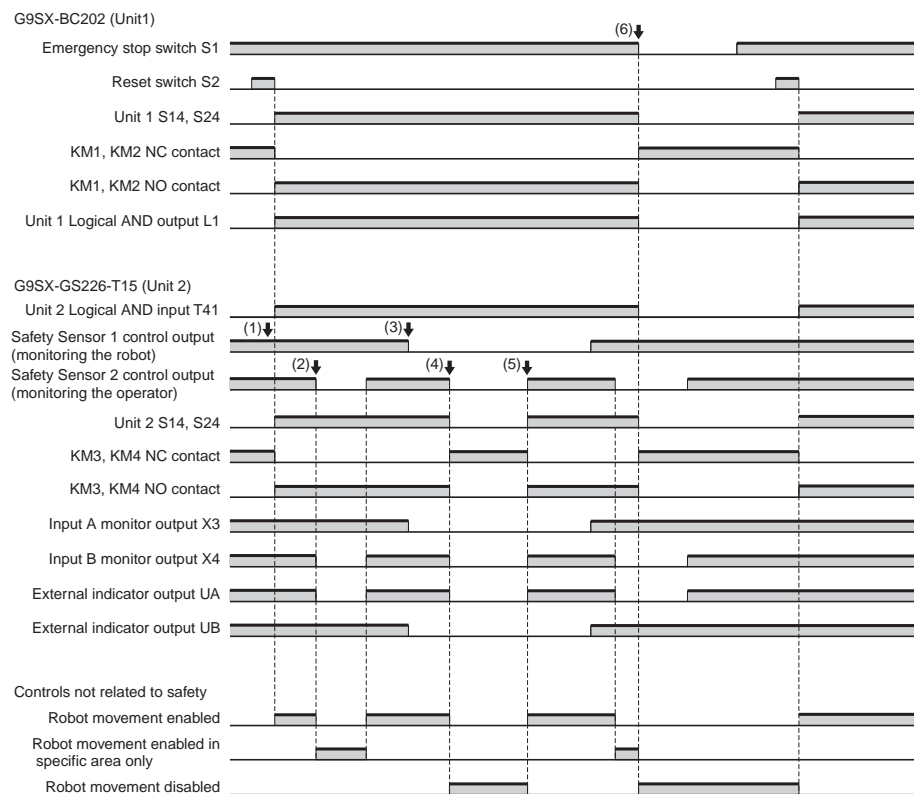

- (1) Prior to operation start
- (2) Operator inserts workpiece
- (3) Robot processes workpiece
- (4) Both operator and robot enter the coordinated area: Only the G9SX-GS stops.
- (5) The G9SX-GS restarts.
- (6) Emergency stop switch pressed: All units stop.

PL/safety category	Model	Stop category	Reset
PLe/4 equivalent	Emergency Stop Switch A165E/A22E Flexible Safety Unit G9SX-BC202 Safety Limit Switch D4B-N/D4N/D4F Guard Lock Safety-door Switch D4NS/D4GS-N/D4BS Safety Key Selector Switch A22TK Flexible Safety Unit G9SX-GS226-T15	M1, M2: 0	Manual

**Note:** The above PL is only the evaluation result of the example. The PL must be evaluated in an actual application by the customer after confirming the usage conditions.

## ● Application Overview

### 1. Normal operating mode

- The safety limit switch S3 and S4 to detect the conveyor cart position are disabled in normal operating mode.

#### 1-1. When the emergency stop switch S1 is pressed.

- The power supply to the motor M1 and M2 is turned OFF immediately when the emergency stop switch S1 is pressed.
- The power supply to the motor M1 is kept OFF until the reset switch S2 is pressed while the emergency stop switch S1 is released.
- The power supply to the motor M2 is kept OFF until the guard is closed and the reset switch S2 and S7 are pressed while the emergency stop switch S1 is released.

#### 1-2. When the guard is opened (the emergency stop switch S1 is released).

- The power supply to the motor M2 is turned OFF immediately when the S5 detects that the guard is opened. (The power supply to the motor M1 is kept ON.)
- The power supply to the motor M2 is kept OFF until the guard is closed and the reset switch S7 is pressed.

### 2. Maintenance mode

- The S5 to detect the opening and closing of the guard is disabled in maintenance mode.

#### 2-1. When the emergency stop switch S1 is pressed.

- The power supply to the motor M1 and M2 is turned OFF immediately when the emergency stop switch S1 is pressed.
- The power supply to the motor M1 is kept OFF until the reset switch S2 is pressed while the emergency stop switch S1 is released.
- The power supply to the motor M2 is kept OFF until the safety limit switch S3 and S4 are turned ON and the reset switch S2 and S7 are pressed while the emergency stop switch S1 is released.

#### 2-2. When the conveyor cart moves away from its safe position (the emergency stop switch S1 is released).

- The S3 and S4 detect the conveyor cart position, and the power supply to the motor M2 is turned OFF. (The power supply to the motor M1 is kept ON.)
- The power supply to the motor M2 is kept OFF until the reset switch S7 is pressed while the safety limit switch S3 and S4 are turned ON.

**Note:** Diagnostic checks for the external indicators connected to external indicator outputs UA and UB can be switched with Y3 and Y4, respectively.

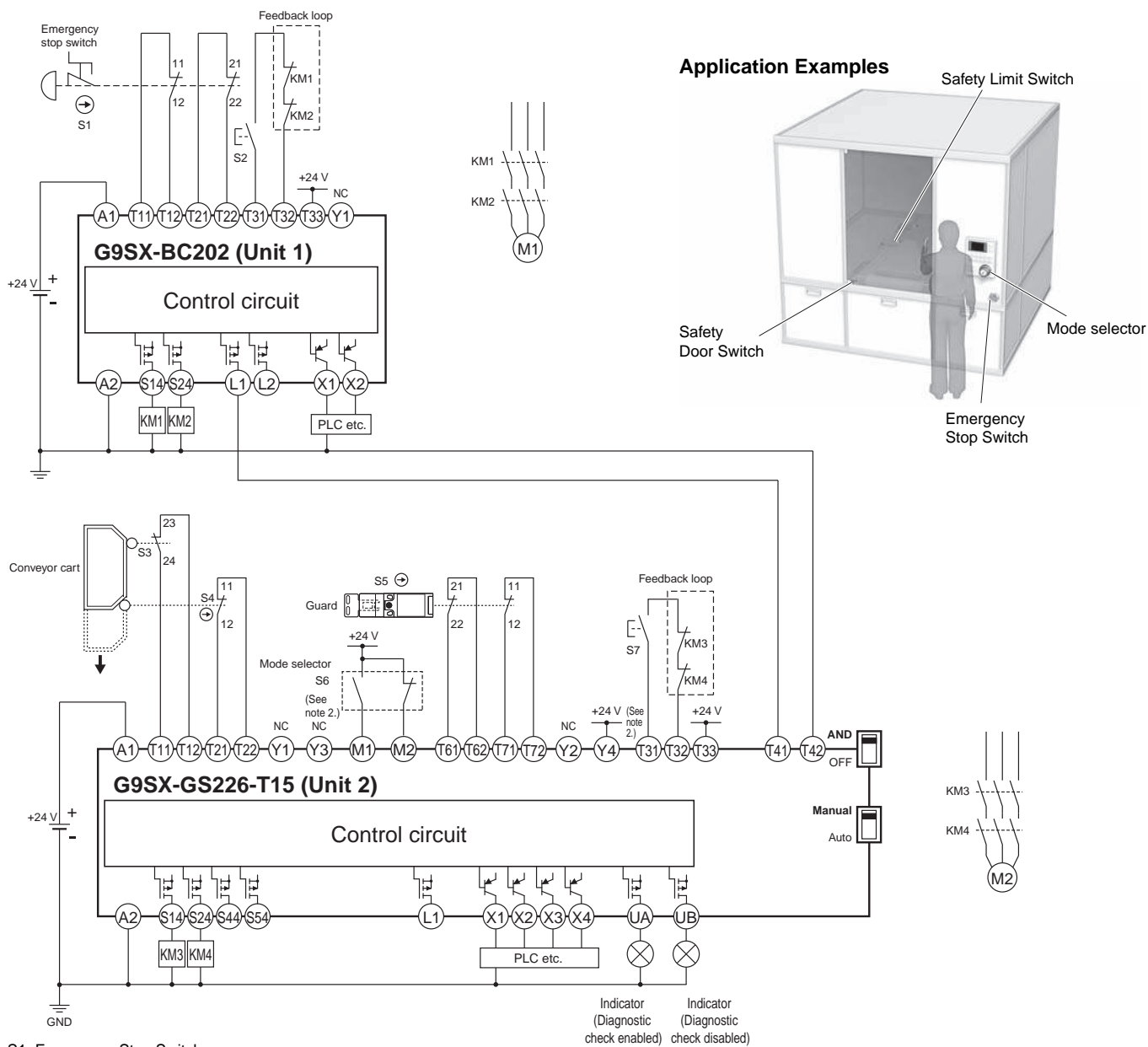

- S1: Emergency Stop Switch
- S2, S7: Reset Switches
- S3, S4: Safety Limit Switches
- S5: Safety Door Switch
- S6: Selector Switch
- KM1 to KM4: Contactors
- M1 and M2: 3-phase motors

Timing Chart 2

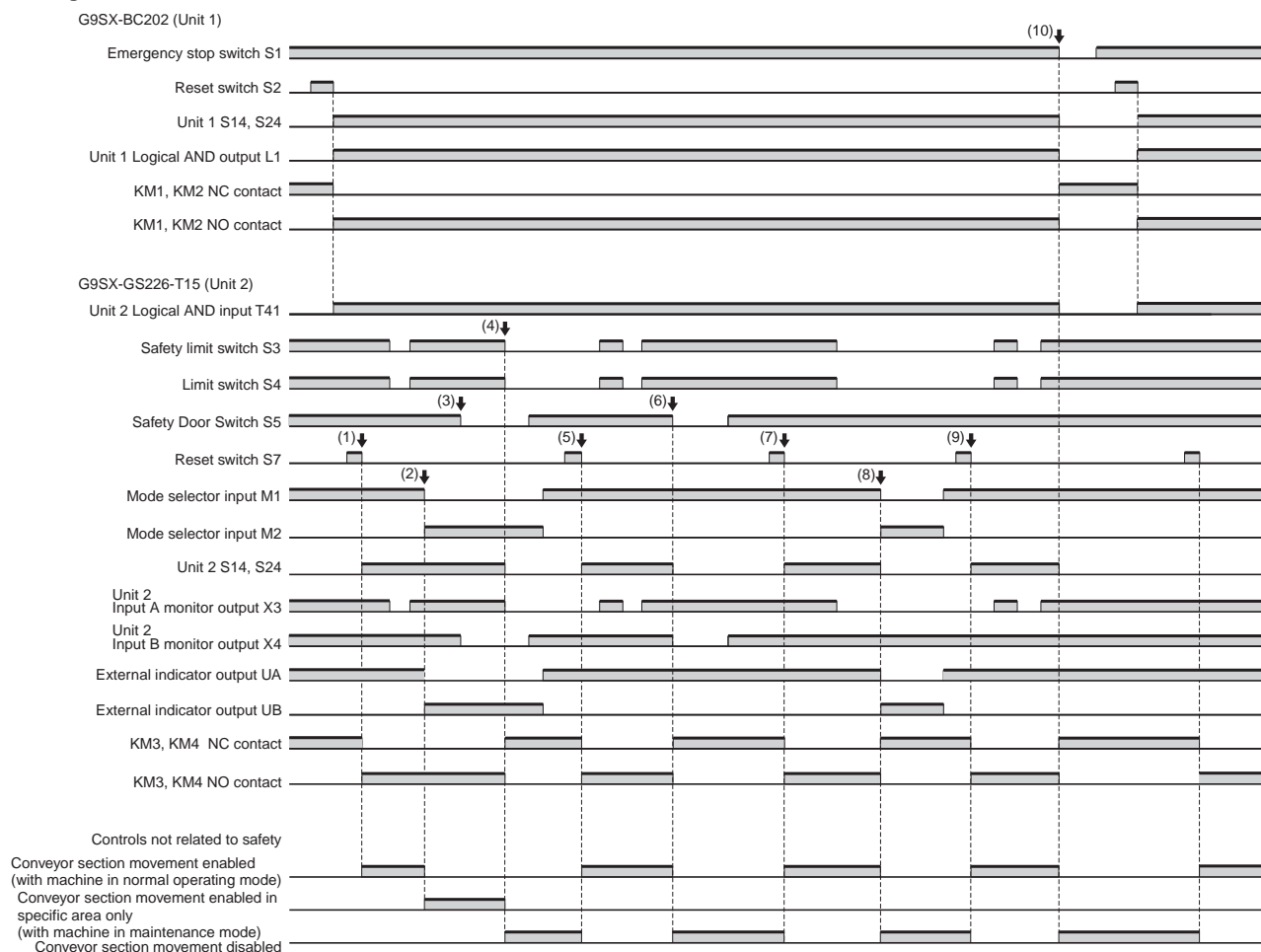

- (1) Start the G9SX-GS in normal operating mode.
- (2) Switch to maintenance mode.
- (3) The operator opens the guard and performs maintenance.
- (4) When Safety Limit Switch S3 and Limit Switch S4 are turned OFF in maintenance mode, the G9SX-GS stops.
- (5) After the guard is closed and the operating mode is switched to normal operating mode, restart the G9SX-GS.
- (6) When the guard is opened during normal operating mode, the G9SX-GS stops.
- (7) Close the guard and restart the G9SX-GS.
- (8) When the operating mode is switched to maintenance mode while Safety Limit Switch S3 and Limit Switch S4 are turned OFF, the G9SX-GS stops.
- (9) Switch to normal operating mode, and when the guard is closed, restart the G9SX-GS.
- (10) Emergency stop switch pressed: All units stop.

**Note: 1.** In this example, press reset switch S2, confirm that the G9SX-BC has started operating, then press reset switch S7.  
**2.** To use the set value of the mode selector for control, use external indicator output UA for control and external indicator output UB for the operator's indication. In this case, disable the diagnostic check of the external indicator output UA.

PL/safety category	Model	Stop category	Reset
PLe/4 equivalent	Emergency Stop Switch A165E/A22E Flexible Safety Unit G9SX-BC202 Safety Limit Switch D4B-N/D4N/D4F Guard Lock Safety-door Switch D4NS/D4GS-N/D4BS Safety Key Selector Switch A22TK Flexible Safety Unit G9SX-GS226-T15 Flexible Safety Unit G9SX-AD322-T15	M1, M2, M3: 0	Manual

**Note:** The above PL is only the evaluation result of the example. The PL must be evaluated in an actual application by the customer after confirming the usage conditions.

### ● Application Overview

1. When the emergency stop switch S1 is pressed.

- The power supply to the motor M1, M2, and M3 is turned OFF immediately when the emergency stop switch S1 is pressed.
- The power supply to the motor M1 is kept OFF until the reset switch S2 is pressed while the emergency stop switch S1 is released.
- The power supply to the motor M2 is kept OFF until the guard 1 is closed and the reset switch S2 and S7 are pressed while the emergency stop switch S1 is released.
- The power supply to the motor M3 is kept OFF until the guard 2 is closed and the reset switch S2 and S9 are pressed while the emergency stop switch S1 is released.

2. When the guard 2 is opened (the emergency stop switch S1 is released).

- The power supply to the motor M3 is turned OFF immediately when the S8 detects that the guard 2 is opened. (The power supply to the motor M1 and M2 is kept ON.)
- The power supply to the motor M3 is kept OFF until the guard 2 is closed and the reset switch S9 is pressed.

3-1. Normal operating mode (When the mode M1 of the G9SX-GS is turned ON.)

The safety limit switch S3 and S4 to detect the conveyor cart position are disabled in normal operating mode.

- The power supply to the motor M2 is turned OFF immediately when the S5 detects that the guard 1 is opened. (The power supply to the motor M1 and M3 is kept ON.)
- The power supply to the motor M2 is kept OFF until the guard 1 is closed and the reset switch S7 is pressed.

3-2. Maintenance mode (When the mode M2 of the G9SX-GS is turned ON.)

The S5 to detect the opening and closing of the guard is disabled in maintenance mode.

- The S3 and S4 detect the conveyor cart position, and the power supply to the motor M2 is turned OFF. (The power supply to the motor M1 and M3 is kept ON.)
- The power supply to the motor M2 is kept OFF until the reset switch S7 is pressed while the safety limit switch S3 and S4 are turned ON.



**Note:** Diagnostic checks for the external indicators connected to external indicator outputs UA and UB can be switched with Y3 and Y4 respectively.

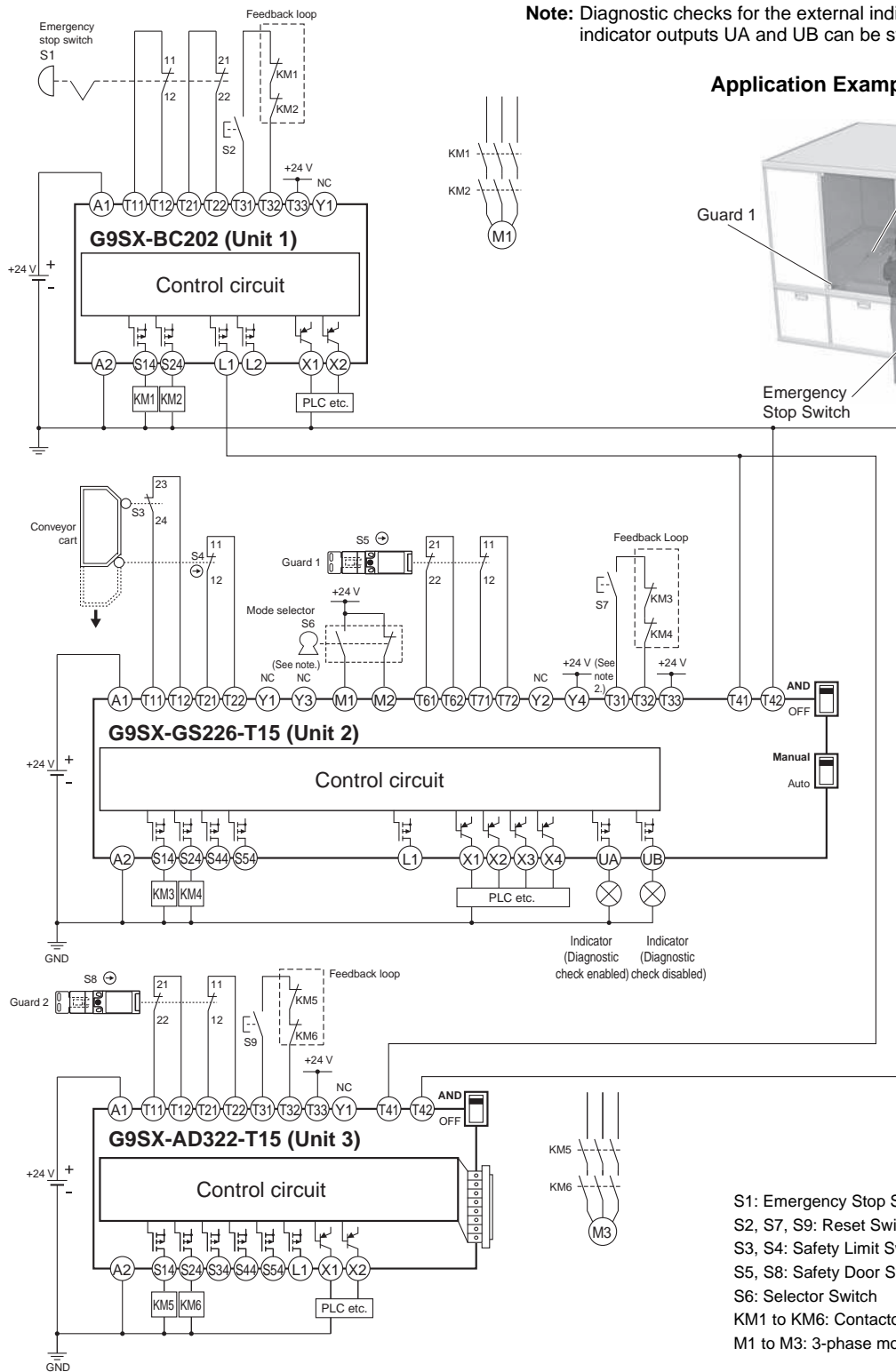

**Application Examples**

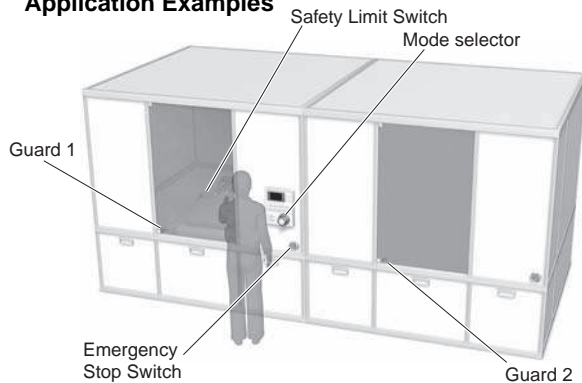

- S1: Emergency Stop Switch
- S2, S7, S9: Reset Switches
- S3, S4: Safety Limit Switches
- S5, S8: Safety Door Switches
- S6: Selector Switch
- KM1 to KM6: Contactors
- M1 to M3: 3-phase motors

Timing Chart 3

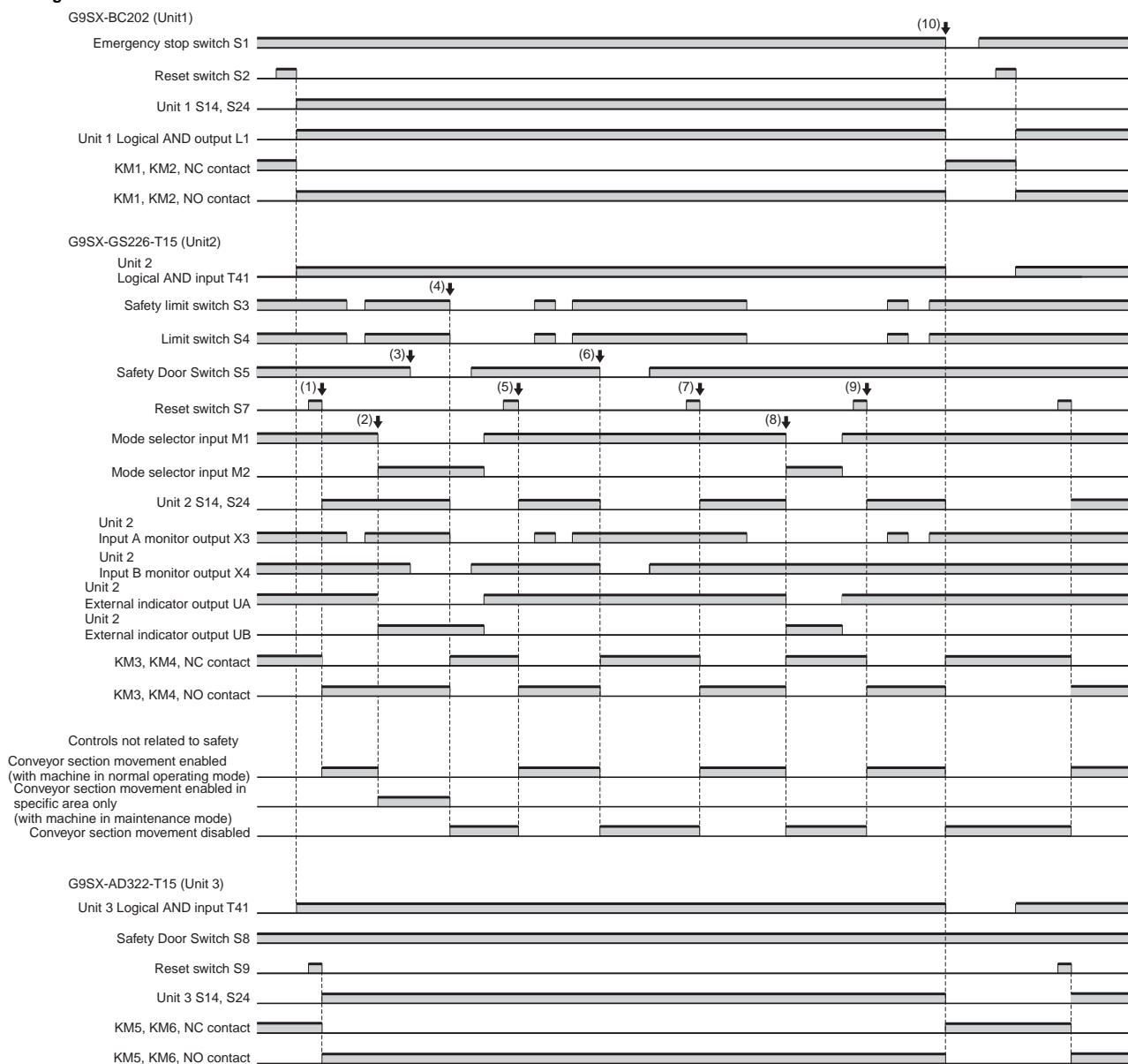

- (1) Start the G9SX-GS in normal operating mode
- (2) Switch to maintenance mode.
- (3) The operator opens the guard 1 and performs maintenance.
- (4) When Safety Limit Switch S3 and Limit Switch S4 are turned OFF in maintenance mode, the G9SX-GS stops.
- (5) After the guard 1 is closed and the operating mode is switched to normal operating mode, restart the G9SX-GS.
- (6) When the guard 1 is opened during normal operating mode, the G9SX-GS stops.
- (7) Close the guard 1 and restart the G9SX-GS.
- (8) When the operating mode is switched to maintenance mode while Safety Limit Switch S3 and Limit Switch S4 are turned OFF, the G9SX-GS stops.
- (9) Switch to normal operating mode, and when the guard 1 is closed, restart the G9SX-GS.
- (10) Emergency stop switch pressed: All units stop.

**Note: 1.** In this example, press reset switch S2, confirm that the G9SX-BC has started operating, then press reset switch S7 and S9.  
**2.** To use the set value of the mode selector for control, use external indicator output UA for control and external indicator output UB for the operator's indication. In this case, disable the diagnostic check of the external indicator output UA.

# Safety Precautions

Refer to “*Precautions for All Relays*” and *Precautions for “Precautions for All Relays with Forcibly Guided Contacts”* for more detailed information.

## Indication and Meaning for Safe Use

<b>⚠ WARNING</b>	Indicates a potentially hazardous situation which, if not avoided, will result in minor or moderate injury, or may result in serious injury or death. Additionally there may be significant property damage.
<b>Precautions for Safe Use</b>	Supplementary comments on what to do or avoid doing, to use the product safely.
<b>Precautions for Correct Use</b>	Supplementary comments on what to do or avoid doing, to prevent failure to operate, or undesirable effect on product performance.

### ⚠ WARNING

#### <Precautions for All G9SX Models>

- Serious injury may possibly occur due to breakdown of safety outputs.  
Do not connect loads beyond the rated value to the safety outputs.
- Serious injury may possibly occur due to loss of required safety functions.  
Wire the G9SX properly so that the safety outputs do not short-circuit with the Unit power supply or load power supply.
- Serious injury may possibly occur due to malfunction of safety outputs.  
Add a circuit to protect against back electromotive force when connecting inductive loads to safety outputs.
- Serious injury may possibly occur due to loss of safety functions. Use appropriate devices as given in the following table.

Control Devices	Requirements
Door interlocking switches or Safety limit switches	Use approved devices with Direct Opening Mechanism complying with IEC/EN 60947-5-1 and capable of switching micro loads of 24 VDC, 5 mA.
Safety sensors	Use approved devices complying with the relevant product standards, regulations and rules in the country where it is used. Consult a certification body to assess that the entire system satisfies the required safety category level.
Relays with forcibly guided contacts	Use approved devices with forcibly guided contacts complying with EN 50205. For feedback purpose use devices with contacts capable of switching micro loads of 24 VDC, 5 mA.
Contactors	Use approved devices complying with IEC/EN 60947-4-1 auxiliary contact linked with power contact (mirror contact). For feedback purpose use devices with contacts capable of switching micro loads of 24 VDC, 5 mA.
Emergency stop switches	Use approved devices with Direct Opening Mechanism complying with IEC/EN 60947-5-1 Do not connect an emergency stop switch to the G9SX-GS□.
Other devices	Evaluate whether devices used are appropriate to satisfy the requirements of safety category level.

#### <G9SX-GS□>

Serious injury may possibly occur due to loss of safety functions. Construct an appropriate safety system as shown in the following table.

Switching function	Auto switching
Safety system configuration example	
Safety precautions	<ol style="list-style-type: none"> <li>Select Safety Sensors that satisfy the following condition: Diameter of the smallest detectable object &lt; Diameter of the object to be detected</li> <li>Install the Safety Sensors so that they satisfy the following conditions: (1) Use Safety Sensor A to detect the entry of the machine into area A, and Safety Sensor B to detect the entry of a person into area A. (2) Make sure that the machine can reach area A only by passing through Safety Sensor A, and that a person can reach area A only by passing through Safety Sensor B.</li> <li>Provide a protective structure to prevent a person from passing completely through Safety Sensor B and stepping into area A. If this is not possible, install a sensor that will detect the presence of a person inside area A and prevent the machine from being restarted while the person is inside area A.</li> <li>Provide a sufficient safety distance (S1) considering the entry speed of a person and a sufficient safety distance (S2) considering the entry speed of the machine. For details, refer to “<i>Safety Distance</i>” on page 48.</li> </ol>
Switching function	Manual switching
Safety system configuration example	
Safety precautions	<ol style="list-style-type: none"> <li>Select Safety Sensors that satisfy the following condition: Diameter of the smallest detectable object &lt; Diameter of the object to be detected</li> <li>Install the Safety Sensors so that they satisfy the following conditions: (1) Use the Safety Sensor to detect the entry of the machine into area A. (2) Make sure that the machine can reach area A only by passing through the Safety Sensor.</li> <li>Provide a protective structure to prevent a person from stepping into area A when the door is opened. If this is not possible, install a sensor that will detect the presence of a person inside area A and prevent the machine from being restarted while the person is inside area A.</li> <li>Provide a sufficient safety distance (S2) considering the entry speed of the machine. For details, refer to “<i>Safety Distance</i>” on page 48.</li> <li>Position the mode selector in a location where it cannot be operated from inside area A.</li> </ol>

## Safety Distance

The safety distance is the minimum distance that must be provided between the safety input device and a machine's hazardous part to stop the hazardous part before a person or object reaches it. The safety distance varies according to the standards of each country and the specifications of each machine. In addition, the calculation of the safety distance differs if the direction of approach is not perpendicular to the detection zone of the safety input device. Always refer to the relevant standards.

### Safety Distance Concepts

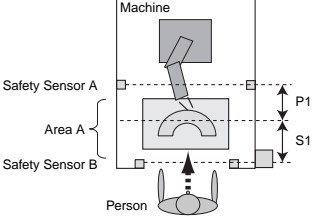
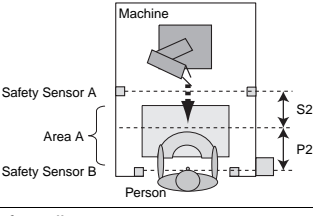
<p><b>When a person approaches a hazard (machine)</b></p>	 <ul style="list-style-type: none"> <li>• S1: Safety distance 1</li> <li>• P1: The closest that a machine can come to a person while operating (the boundary of the machine's operating area)</li> </ul>
<p><b>When a hazard (machine) approaches a person</b></p>	 <ul style="list-style-type: none"> <li>• S2: Safety distance 2</li> <li>• P2: The closest that a part of a person can come to a machine.</li> </ul>

### Safety Distance Calculation Examples (Reference)

<p><b>Calculating the safety distance specified by international standard ISO 13855-2002 (European standard EN 999-1999)</b></p>	<p>If a person approaches the detection zone perpendicularly, calculate the safety distance as shown below.</p> $S1 = K1 \times T + C$ $S2 = K2 \times T + C$ <p>S1: Safety distance 1 S2: Safety distance 2 K1: Approach speed of a person to the detection zone (area A) K2: Maximum approach speed of a machine to the detection zone (area A) T: Total response time of the machine and G9SX system C: Additional distance calculated by the detection capability (the diameter of the smallest detectable object) of the Safety Sensor.</p>
<p><b>Calculating the safety distance specified by American standard ANSI B11.19</b></p>	<p>If a person approaches the detection zone perpendicularly, calculate the safety distance as shown below.</p> $S1 = K1 \times (Ts + Tc + Tr + Tbm) + Dpf$ $S2 = K2 \times (Ts + Tc + Tr + Tbm) + Dpf$ <p>S1: Safety distance 1 S2: Safety distance 2 K1: Approach speed of a person to the detection zone (area A) K2: Maximum approach speed of a machine to the detection zone (area A) Ts: Machine's stop time (s) Tr: Response time of the G9SX system from ON to OFF (s) Tc: Machine control circuit's maximum response time required to activate its brake (s) Tbm: Additional time (s) Dpf: Additional distance</p>

1. To determine the approach speed K1, consider all factors, including the operator's physical abilities.
2. To determine the maximum approach speed K2, consult with a notified body or other authoritative institutes.
3. The response time of a machine is the time from when the machine receives a stop signal to the time when the machine's hazardous part stops. Measure the response time on the actual system. Also, periodically check that the machine's response time has not changed.
4. For information on the response time of the G9SX system, refer to item 10 of "Precautions for Correct Use" on page 49.

## Precautions for Safe Use

### <Precautions for All G9SX Models>

1. Use G9SX within an enclosure with IP54 protection or higher of IEC60529.
2. Incorrect wiring may lead to loss of safety function. Wire conductors correctly and verify the operation of G9SX before commissioning the system in which G9SX is incorporated.
3. Do not apply DC voltages exceeding the rated voltages, or any AC voltages to the G9SX power supply input.
4. Use DC supply satisfying requirements below to prevent electric shock.
  - DC power supply with double or reinforced insulation, for example, according to IEC/EN60950 or EN50178 or a transformer according to IEC/EN61558.
  - DC supply satisfies the requirement for class 2 circuits or limited voltage/current circuit stated in UL 508.
5. Apply properly specified voltages to G9SX inputs. Applying inappropriate voltages cause G9SX to fail to perform its specified function, which leads to the loss of safety functions, damages to G9SX, or burning.
6. Auxiliary error outputs and auxiliary monitoring outputs are NOT safety outputs. Do not use auxiliary outputs as any safety output. Such incorrect use causes loss of safety function of G9SX and its relevant system. Also Logical AND connection outputs can only be used for logical AND connections between G9SXs.
7. After installation of G9SX, qualified personnel should confirm the installation, and should conduct test operations and maintenance. The qualified personnel should be qualified and authorized to secure the safety on each phases of design, installation, running, maintenance and disposal of system.
8. A person in charge, who is familiar to the machine in which G9SX is to be installed, should conduct and verify the installation.
9. Inspect the G9SX daily and every six months. Incorrect system operation may result in serious injury.
10. Do not dismantle, repair, or modify G9SX. It may lead to loss of its safety functions, creating a dangerous situation.
11. Use only appropriate components or devices complying with relevant safety standards corresponding to the required level of safety categories. Conformity to requirements of safety category is determined as an entire system. It is recommended to consult a certification body regarding assessment of conformity to the required safety level.
12. OMRON shall not be responsible for conformity with any safety standards regarding to customer's entire system.
13. Disconnect G9SX from power supply when wiring, to prevent electric shock or unexpected operation.
14. Be cautious not to have your fingers caught when attaching terminal sockets to the plugs on G9SX.
15. Do not use in combustible gases or explosive gases.

## &lt;G9SX-GS□&gt;

1. Be sure to correctly connect safety input devices to safety input A and safety input B to ensure proper operation of the safety functions.
2. When setting the Switching Function, be sure to consider safety control requirements, safety level and safety category of the entire system.
3. A qualified personnel who has a thorough understanding of the installed machine must switch the mode selector input. For example, a Switching Unit with Key must be used for the mode selector, and the key must be managed and used in such a way that the machine cannot be operated by unauthorized persons.

## &lt;G9SX-EX□&gt;

1. The durability of relays depend greatly on the switching condition. Confirm the actual conditions of operation in which the relay will be used in order to make sure of the permissible number of switching operations.

<b>Precautions for Correct Use</b>
------------------------------------

## &lt;Precautions for All G9SX Models&gt;

1. Handle with care  
Do not drop G9SX to the ground or expose to excessive vibration or mechanical shocks. G9SX may be damaged and may not function properly.
2. Conditions of storage  
G9SX may be damaged and may not function properly. Do not store in such conditions stated below.
  1. In direct sunlight
  2. At ambient temperatures out of the range of  $-10$  to  $55^{\circ}\text{C}$ .
  3. At relative humidity out of the range of 25% to 85% or under such temperature change that causes condensation.
  4. In corrosive or combustible gases
  5. With vibration or mechanical shocks out of the rated values.
  6. Under splashing of water, oil, chemicals
  7. In the atmosphere containing dust, saline or metal powder.
3. Mounting  
Mount G9SX to DIN track with attachments (PFP-M, not incorporated to this product), not to drop off the track by vibration or other force especially when the length of DIN track is short compared to the widths of G9SX.
4. Following spacing around G9SX should be available to apply rated current to outputs of G9SX and for enough ventilation and wiring:
  1. At least 25 mm beside side faces of the G9SX.
  2. At least 50 mm above top face of G9SX and below bottom face of G9SX.

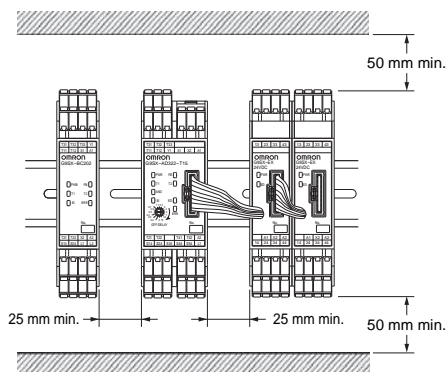

## 5. Wiring

## (1) G9SX

- Wire the G9SX as described below.

<b>Solid wire</b>	0.2 to 2.5 mm <sup>2</sup> (AWG24 to AWG12)
<b>Stranded wire</b>	0.2 to 2.5 mm <sup>2</sup> (AWG24 to AWG12)

- Strip no more than 7 mm of insulation from the end of the wire.
- (2) G9SX-□-RT (with Screw Terminals)
    - Tighten each screw to 0.5 to 0.6 N·m or the G9SX-□-RT may malfunction or generate heat.
  - (3) Wiring for a Logical AND Connection
    - Use a 2-conductor cable or shielded cable to wire a logical AND connection between Units.
6. Connecting Expansion Units (G9SX-EX□-□):  
(Only G9SX-AD□/-ADA□/-NSA□/-GS□)
    - (1) Remove the termination connector from the G9SX, and insert the connector of the Expansion Unit into the G9SX to connect it.
    - (2) Insert the termination connector into the last Expansion Unit as viewed from the G9SX. When the G9SX is used without any Expansion Units, do not remove the termination connector from the G9SX.
    - (3) Do not remove the termination connector while the system is operating.
    - (4) Before applying the power supply voltage, confirm that the connecting sockets and plugs are locked.
    - (5) Make sure that all connected Expansion Units are supplied with power within 10 s after the power to the G9SX is turned ON. Otherwise, the G9SX will detect a power supply error for the Expansion Units.
  7. Use cables with a length of 100 m maximum to connect the safety inputs, feedback/reset input, logical AND connection input, logical AND connection output, or mode selector inputs.
  8. Set the time duration of OFF-delay to an appropriate value that does not cause the loss of safety function of system.
  9. Logical AND connection between Units
    1. When using Logical AND connection inputs, set the Logical AND connection preset switch to 'AND' position for the units which the logical AND connection signal are input to.
    2. Connect Logical AND connection outputs appropriately to Logical AND connection inputs of the relevant unit. Verify the operation of G9SX before commissioning the system.
    3. Give careful consideration to the response time delay during logical AND connection in order to prevent any reduction in the safety of the safety control system.
    4. Use two-conductor cable or shielded cable for wiring the logical AND connections between Units.
  10. To determine the safety distance to hazards, take into account the delay of safety outputs caused by the following times:
    - (1) Response time of safety inputs
    - (2) Response time of logical AND connection input  
(Also consider the precaution in "\*" below)
    - (3) Preset OFF-delay time
    - (4) Accuracy of OFF-delay time
- \* When connecting multiple Units with logical AND connections, the operating time and response time after logical AND connection inputs will be the sum of the operating times and response times of the Units that are connected in series by logical AND connections.



11. Start entire system after more than 5 s have passed since applying supply voltage to all G9SXs in the system.
12. Power Supply
  - (1) The G9SX may malfunction due to electromagnetic disturbances. Be sure to connect terminal A2 to ground.
  - (2) When sharing a power supply with a Safety Light Curtain, use a power supply that will not fail for a momentary power interruption of 20 ms or less.
13. Devices connected to G9SX may operate unexpectedly. When replacing G9SX, disconnect it from power supply.
14. Adhesion of solvent such as alcohol, thinner, trichloroethane or gasoline on the product should be avoided. Such solvents make the marking on G9SX illegible and cause deterioration of parts.
15. Do NOT mix AC load and DC load to be switched in one G9SX-EX□-□. When switching of both AC load and DC load is necessary, connect more than two G9SX-EX□-□ and use each unit for AC load and DC load exclusively.
16. Operate the reset input more than 0.4 seconds immediately after the safety outputs are OFF.  
G9SX does not accept the reset input from when the outputs are turned ON and until 0.4 seconds passes after the outputs are turned OFF.

#### <G9SX-GS>

1. Use a mode selector that has an SPST-NO + SPST-NC contact form (e.g., OMRON's A22K□-11).

#### Safety Category (EN ISO 13849-1)

In the condition shown in *Application Examples*, G9SX can be used for the corresponding categories up to Safety category 4 per EN ISO13849-1.

This does NOT mean that G9SX can always be used for required category under all the similar conditions and situations.

Conformity to the categories must be assessed as a whole system. When using G9SX for safety categories, be sure to confirm the conformity as a whole system.

#### Applicable Safety Category 4 (EN ISO13849-1)

1. Input signals to both safety inputs (T11-T12, T21-T22, T61-T62, and T71-T72).
2. Input signals to the safety inputs (T11-T12, T21-T22, T61-T62, and T71-T72) through switches equipped with a direct opening mechanism.  
When using limit switches, at least one of them must have a direct opening mechanism.
3. When connecting a Safety Sensor to the G9SX, use a TYPE 4 Safety Sensor.
4. Input the signal through a NC contact of the contactor to Feedback/Reset input (T31-T32 for manual reset or T31-T33 for auto reset).
5. Keep the cross fault detection mode input (Y1 and Y2) open.  
However, when connecting devices that have a self-diagnosis function, such as Safety Sensors, apply 24 VDC to Y1 or Y2.
6. Be sure to connect A2 to ground.
7. When using a G9SX-EX□-□ Expansion Unit, connect fuses with a current rating of 3.15 A maximum to the safety relay outputs to prevent the contacts from welding.

## Compliance with International Standards

Item	Model	G9SX-AD G9SX-ADA	G9SX-BC	G9SX-GS	G9SX-EX
Approved by TÜV SÜD	EN60204-1	Approved	Approved	Approved	Approved
	EN ISO13849-1 PLe/Safety Category 4	Approved	Approved	Approved	Approved
	EN61508 SIL3	Approved	Approved	Approved	Approved
	EN62061 SIL3	Not approved	Not approved	Approved	Not approved
	IEC/EN60947-5-2	Not approved	Not approved	Not approved	Not approved
	IEC/EN60947-5-3 PDF-M	Not approved	Not approved	Not approved	Not approved
Approved by UL	UL508	Approved	Approved	Approved	Approved
	UL1998	Approved	Approved	Approved	Approved
	CAN/CSA C22.2 No.142	Approved	Approved	Approved	Approved
Approved by KOSHA		Approved	Approved	Approved	Approved

## Terms and Conditions Agreement

### Read and understand this catalog.

Please read and understand this catalog before purchasing the products. Please consult your OMRON representative if you have any questions or comments.

### Warranties.

(a) Exclusive Warranty. Omron's exclusive warranty is that the Products will be free from defects in materials and workmanship for a period of twelve months from the date of sale by Omron (or such other period expressed in writing by Omron). Omron disclaims all other warranties, express or implied.

(b) Limitations. OMRON MAKES NO WARRANTY OR REPRESENTATION, EXPRESS OR IMPLIED, ABOUT NON-INFRINGEMENT, MERCHANTABILITY OR FITNESS FOR A PARTICULAR PURPOSE OF THE PRODUCTS. BUYER ACKNOWLEDGES THAT IT ALONE HAS DETERMINED THAT THE PRODUCTS WILL SUITABLY MEET THE REQUIREMENTS OF THEIR INTENDED USE.

Omron further disclaims all warranties and responsibility of any type for claims or expenses based on infringement by the Products or otherwise of any intellectual property right. (c) Buyer Remedy. Omron's sole obligation hereunder shall be, at Omron's election, to (i) replace (in the form originally shipped with Buyer responsible for labor charges for removal or replacement thereof) the non-complying Product, (ii) repair the non-complying Product, or (iii) repay or credit Buyer an amount equal to the purchase price of the non-complying Product; provided that in no event shall Omron be responsible for warranty, repair, indemnity or any other claims or expenses regarding the Products unless Omron's analysis confirms that the Products were properly handled, stored, installed and maintained and not subject to contamination, abuse, misuse or inappropriate modification. Return of any Products by Buyer must be approved in writing by Omron before shipment. Omron Companies shall not be liable for the suitability or unsuitability or the results from the use of Products in combination with any electrical or electronic components, circuits, system assemblies or any other materials or substances or environments. Any advice, recommendations or information given orally or in writing, are not to be construed as an amendment or addition to the above warranty.

See <http://www.omron.com/global/> or contact your Omron representative for published information.

### Limitation on Liability; Etc.

OMRON COMPANIES SHALL NOT BE LIABLE FOR SPECIAL, INDIRECT, INCIDENTAL, OR CONSEQUENTIAL DAMAGES, LOSS OF PROFITS OR PRODUCTION OR COMMERCIAL LOSS IN ANY WAY CONNECTED WITH THE PRODUCTS, WHETHER SUCH CLAIM IS BASED IN CONTRACT, WARRANTY, NEGLIGENCE OR STRICT LIABILITY.

Further, in no event shall liability of Omron Companies exceed the individual price of the Product on which liability is asserted.

### Suitability of Use.

Omron Companies shall not be responsible for conformity with any standards, codes or regulations which apply to the combination of the Product in the Buyer's application or use of the Product. At Buyer's request, Omron will provide applicable third party certification documents identifying ratings and limitations of use which apply to the Product. This information by itself is not sufficient for a complete determination of the suitability of the Product in combination with the end product, machine, system, or other application or use. Buyer shall be solely responsible for determining appropriateness of the particular Product with respect to Buyer's application, product or system. Buyer shall take application responsibility in all cases.

NEVER USE THE PRODUCT FOR AN APPLICATION INVOLVING SERIOUS RISK TO LIFE OR PROPERTY OR IN LARGE QUANTITIES WITHOUT ENSURING THAT THE SYSTEM AS A WHOLE HAS BEEN DESIGNED TO ADDRESS THE RISKS, AND THAT THE OMRON PRODUCT(S) IS PROPERLY RATED AND INSTALLED FOR THE INTENDED USE WITHIN THE OVERALL EQUIPMENT OR SYSTEM.

### Programmable Products.

Omron Companies shall not be responsible for the user's programming of a programmable Product, or any consequence thereof.

### Performance Data.

Data presented in Omron Company websites, catalogs and other materials is provided as a guide for the user in determining suitability and does not constitute a warranty. It may represent the result of Omron's test conditions, and the user must correlate it to actual application requirements. Actual performance is subject to the Omron's Warranty and Limitations of Liability.

### Change in Specifications.

Product specifications and accessories may be changed at any time based on improvements and other reasons. It is our practice to change part numbers when published ratings or features are changed, or when significant construction changes are made. However, some specifications of the Product may be changed without any notice. When in doubt, special part numbers may be assigned to fix or establish key specifications for your application. Please consult with your Omron's representative at any time to confirm actual specifications of purchased Product.

### Errors and Omissions.

Information presented by Omron Companies has been checked and is believed to be accurate; however, no responsibility is assumed for clerical, typographical or proofreading errors or omissions.

2017.6

In the interest of product improvement, specifications are subject to change without notice.

**OMRON Corporation**  
Industrial Automation Company

<http://www.ia.omron.com/>

(c)Copyright OMRON Corporation 2017 All Right Reserved.