

## Compact Body, High-visibility Indicators, and Ideal for Picking Systems for Small Parts.

- A variety of part sizes can be handled: F3W-D sensing width: 100 mm, F3W-E sensing width: 50 mm.
- Low-profile Sensor with thickness of 8 mm and enlargeable work opening.
- Models with connectors are also available. Support for XS5 Smartclick Connectors reduces work and simplifies wiring.

 Be sure to read *Safety Precautions* on page 7.



## Features

### Subminiature Size: 70-mm Length, 8-mm Depth

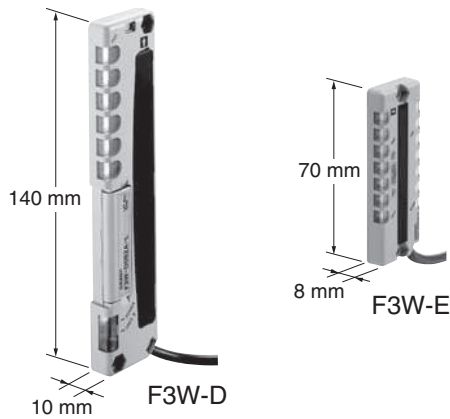

### High-visibility Indicators Arranged in Two Directions



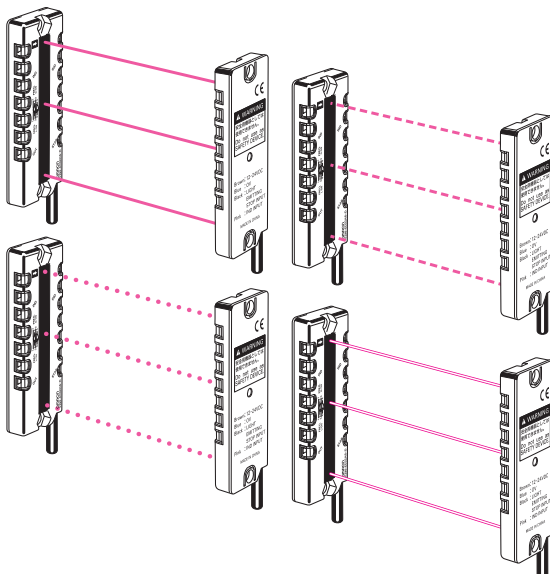

### Mutual Interference Prevention with Four Frequencies



## Ordering Information



### Sensors

 Infrared LED

Sensing method	Appearance	Connection method (cable length)	Sensing distance		Beams		Sensing width (mm)	Output type	Model
					Gap	Qty			
Through-beam		Pre-wired (2 m)		300 mm	25 mm	3	50	NPN open collector	F3W-E032A6
		Pre-wired connector (0.3 m)						PNP open collector	F3W-E032A8
								NPN open collector	F3W-E032B6
								PNP open collector	F3W-E032B8

### Accessories (Order Separately)

#### Mounting Brackets

Appearance	Model	Qty	Remarks
	F39-LE2	2	L-shaped Mounting Bracket
	F39-LE1	2	Flat Mounting Bracket

#### Protective Bracket

Appearance	Model	Qty
	F39-LE3	2

# F3W-E

## Ratings and Specifications

Sensing method		Through-beam	
		F3W-E032A6/A8	F3W-E032B6/B8
Item	Model		
Sensing distance		30 to 300 mm	
Beam gap		25 mm	
Number of beams		3	
Sensing width		50 mm	
Standard sensing object		Opaque, 28-mm dia. min.	
Light source (emission wavelength)		Infrared LED (860 nm)	
Power supply voltage		12 to 24 VDC $\pm$ 10% (ripple (p-p): 10% max.)	
Current consumption		Emitter: 40 mA max., Receiver: 40 mA max.	
Control output		NPN or PNP open collector output Load power supply: 30 VDC, Load current: 100 mA max. (Residual voltage: 1.8 V max.) Dark-ON or Light-ON (selectable)	
Picking instruction indicator input		Relay or open collector input NPN input Indicator ON: Input voltage of 0 to 2 V Indicator OFF: Open (with leakage current of 0.1 mA max.) PNP input Indicator ON: Input voltage: (+DC – 2 V) to +DC * Indicator OFF: Open (with leakage current of 0.1 mA max.)	
Emission stop input		Relay or open collector input NPN input Emission stop input voltage: 0 to 2 V Emission input voltage: Open (with leakage current of 0.1 mA max.) PNP input Emission stop input voltage: (+DC – 2 V) to +DC * Emission input voltage: Open (with leakage current of 0.1 mA max.)	
Protection circuits		Reverse-connection protection, output short protection, and mutual interference prevention function (set with frequency switch)	
Response time		Operate/Reset: 100 ms max.	
Indicators	Receiver	Operation indicator (orange), stability indicator (green), and picking indicators (orange)	
	Emitter	Power indicator (green), emission stop indicator (orange), and picking indicators (orange)	
Ambient temperature		Operating: –10 to 55°C, Storage: –25 to 70°C (with no icing or condensation)	
Ambient humidity		Operating/storage: 35% to 85% (with no condensation)	
Ambient illumination		Sunlight: 10,000 lx at light-receiving surface, Incandescent light: 3,000 lx at light-receiving surface	
Insulation resistance		20 M $\Omega$ min. (at 500 VDC)	
Dielectric strength		1,000 VAC, 50/60 Hz for 1 min	
Vibration resistance (destruction)		10 to 50 Hz, 1.5-mm double-amplitude for 2 hours each in X, Y, and Z directions	
Shock resistance (destruction)		500 m/s <sup>2</sup> , 3 times in X, Y, and Z directions	
Degree of protection		IP62 (IEC60529)	
Connection method		Pre-wired Standard cable length: 2 m	Pre-wired connector Standard cable length: 0.3 m (M12, 4-pin connector)
Weight (packed state)		Approx. 125 g	Approx. 85 g
Materials	Case	ABS resin	
	Lens	Acrylic resin	
	Cable	Oil-resistant PVC	
Accessories		Instruction manual	

\*+DC is the power supply voltage.

# Engineering Data (Typical)

## Parallel Operating Range

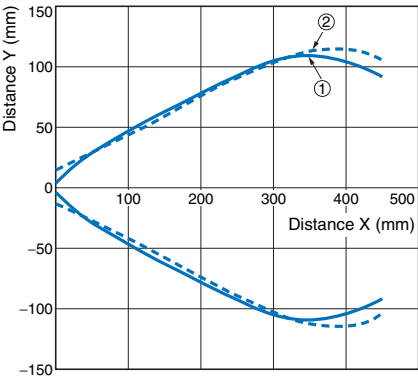

1. Horizontal Movement Characteristics 2. Vertical Movement Characteristics

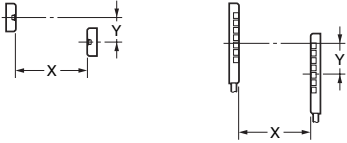

## Angle Characteristic

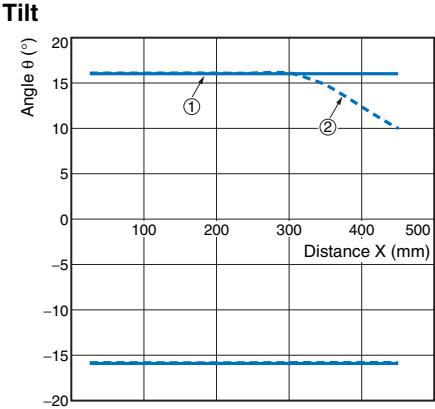

1. Emitter Angle Characteristics

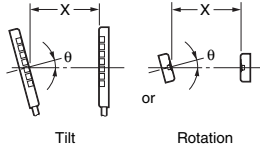

2. Receiver Angle Characteristics

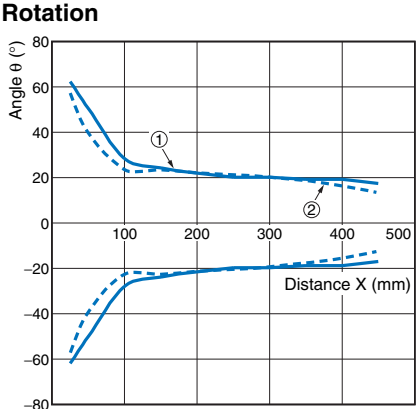
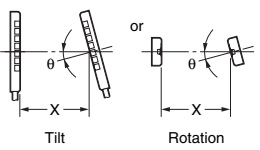

# F3W-E

## I/O Circuits

### NPN Open-collector Outputs

Model	Operation mode	Timing chart	Mode selector switch	Output circuit
F3W -E032A6 F3W -E032B6	Dark-ON mode  ON: One beam or more is interrupted OFF: No beam is interrupted	<p><b>Note:</b> The control output will turn ON if the emission stop input is received.</p>	D-ON (DARK ON)	<p>The following figure gives the relation between the picking instruction input and the picking indicators.</p>
	Light-ON mode  ON: No beam is interrupted OFF: One beam or more is interrupted	<p><b>Note:</b> The control output will turn OFF if the emission stop input is received.</p>	L-ON (LIGHT ON)	

Note: The emission stop input cannot be used with pre-wired connector models.

### PNP Open-collector Outputs

Model	Operation mode	Timing chart	Mode selector switch	Output circuit
F3W -E032A8 F3W -E032B8	Dark-ON mode  ON: One beam or more is interrupted OFF: No beam is interrupted	<p><b>Note:</b> The control output will turn ON if the emission stop input is received.</p>	D-ON (DARK ON)	<p>The following figure gives the relation between the picking instruction input and the picking indicators.</p>
	Light-ON mode  ON: No beam is interrupted OFF: One beam or more is interrupted	<p><b>Note:</b> The control output will turn OFF if the emission stop input is received.</p>	L-ON (LIGHT ON)	

Note: The emission stop input cannot be used with pre-wired connector models.

### Connector Pin Arrangement

#### NPN/PNP Open Collector Outputs

#### F3W-E032B6/B8



Receiver	
Pin number	Specification
1	+V
2	Picking instruction input
3	0 V
4	Control output

Emitter	
Pin number	Specification
1	+V
2	Picking instruction input
3	0 V
4	Open

Setting Method

NPN/PNP Open Collector Outputs

Mode Selector

The operation modes (i.e., Dark-ON or Light-ON) can be selected using the receiver selector switch. Also, the operating frequencies used between pairs of emitters can be selected from four frequencies to prevent mutual interference.

Selector Switch Settings

Operation mode	Light-ON		Dark-ON	
	Emitter	Receiver	Emitter	Receiver
1				
2				
3				
4				

Note: Always turn OFF the power supply before setting the selector switch.

Nomenclature

NPN/PNP Open Collector Outputs

Emitter

F3W-E032A6/A8-L  
F3W-E032B6/B8-L

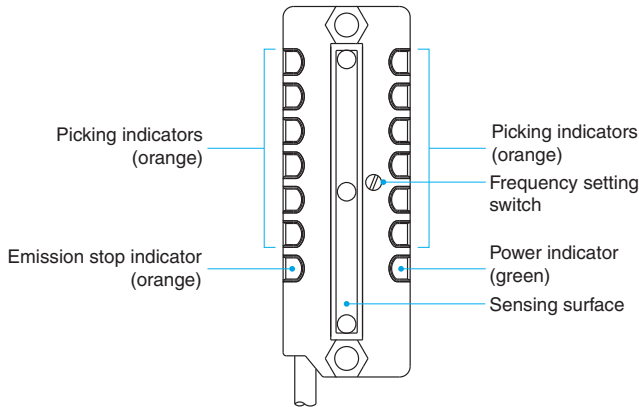

Receiver

F3W-E032A6/A8-D  
F3W-E032B6/B8-D

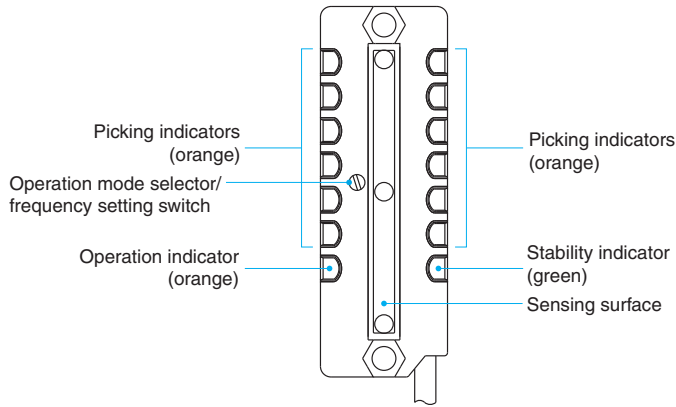

Indicators	Indication details
Power indicator	Lit when the power is supplied.
Picking indicators	Lit when a picking instruction input is received.
Operation indicator	Lit when the control output is ON.
Stability indicator	Lit when stable light is received. Flashing when light is unstable and OFF when dark.
Emission stop indicator	Lit when emission is OFF due to the emission stop input.

# F3W-E

## Safety Precautions

Refer to *Warranty and Limitations of Liability*.

### ⚠ WARNING

**Do not apply the F3W-E as safety mechanisms used in pressing machines or any other safety mechanisms for protecting the human body from danger.**



- (1) Do not apply the F3W-E as safety mechanisms used in pressing machines, shears, rolling machines, spinning machines, cotton mill machines, or robots for the protection of an operator's hands and body.
- (2) The F3W-E is designed for detection of the human body or moving objects in the detection area but not for protection against danger.
- (3) The F3W-E or any product incorporating the F3W-E may be exported to any country. Should the F3W-E cause any problem conflicting with local laws or related to product liability locally, however, OMRON shall, without exception, assume no responsibility for it.

### ⚠ CAUTION

Before using more than one F3W-E Sensor in parallel or series, take necessary countermeasures against mutual interference so that the Sensors will not malfunction. Refer to *Mutual Interference Prevention Function* on the right.

### Precautions for Safe Use

#### ● Operating Environment

- Do not use the Sensor in an environment containing flammable or volatile gases.
- Do not use the Sensor underwater.
- Do not disassemble, repair, or modify the Sensor.
- Always turn OFF the system power before installing or replacing the Sensor.

### Precautions for Correct Use

Do not use the product in atmospheres or environments that exceed product ratings.

#### ● System Design

##### Mutual Interference Prevention Function

#### 1. Mutual Interference Prevention with Sets of Two to Four Sensors

Set these Sensors to different frequencies with the frequency selector. Refer to *Setting Method* on page 6.

If the mutual interference prevention function is not used, and there are two Sensors with the same frequency setting, a beam from the Emitter of one Sensor may hit the Receiver of the other Sensor, resulting in malfunction.

This function cannot prevent mutual interference between the F3W-E Sensor and a Photoelectric Sensor of a different model.

#### 2. Five or More Sets of Sensors:

When 5 or more sets of Sensors are used in parallel, mutual interference may result in malfunction. Take the following measures to prevent mutual interference, and check for mutual interference.

- The distance between two adjacent sets of Sensors must be at least  $l_1$  or  $l_2$ , which does not cause mutual interference between two Sensors with the same frequency setting.  $l_1$  or  $l_2$  is at least 1.5 times the distance shown in Parallel Operating Range of the Engineering Data.

#### Vertical Installation

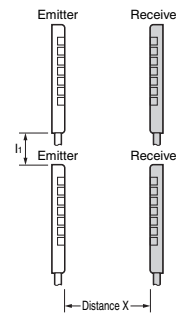

#### Horizontal Installation

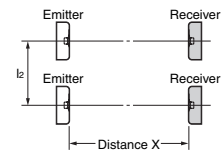

- Install a light baffle so that there will not be mutual interference between Sensors with the same frequency setting. (See *Figure 1*.)

Light reflections from the wall or floor may go around a light baffle and reach the Receivers. Install a light baffle so that it will also block any light reflections. (See *Figure 2*.)

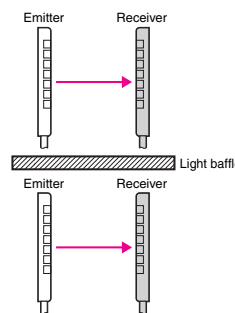

(Figure 1)

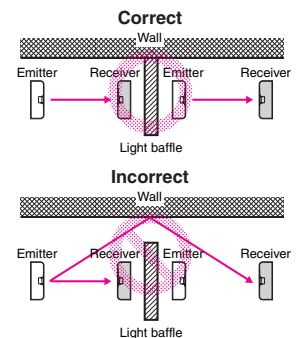

(Figure 2)

● **Wiring Precautions**

**Connection**

- Before turning ON the power, make sure that the supply voltage is within the maximum allowable voltage range.
- Be very careful not to get metal chips in the connector, especially during wiring.
- As a general rule, do not wire high-voltage lines or power lines along with the lines of the F3W-E in the same conduit. Otherwise, the F3W-E may be damaged or malfunction due to inductive noise.
- Use an extension cable with a cross-sectional area of 0.3 mm<sup>2</sup> min. and length of 100 m max.
- Incorrect wiring may damage the equipment. Make sure that the cable length and routing are appropriate to prevent the connectors and cables from getting disconnected.
- Applying excessive force to the mode selector switch may result in damage. Do not apply a force of more than 5 N.

**Cables**

Make sure that the bending radius is 25 mm or more.

● **Installation Precautions**

**Installation**

- Install the Sensor so that its sensing face will not receive light from the sun, fluorescent lamps, incandescent lamps, and other light sources.
- Do not strike the Sensor with a hammer or any other tool during installation, otherwise the internal circuits of the Sensor may be damaged.
- Install the Emitter and Receiver in the same orientation as shown in the following figure. (The cables must be in the same direction.)

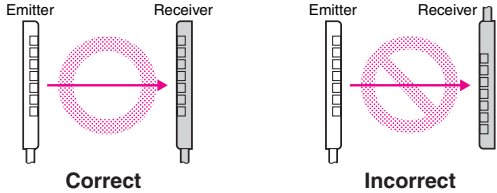

- Use M4 screws to secure the Sensor body.
- Secure the case to a tightening torque of 0.5 N·m or less.

**Reflection from Wall or Floor**

If the Emitter and Receiver are installed as shown in the following illustration, all the axes may not be interrupted due to light reflection from the floor or wall. Make sure that the Emitter and Receiver detect the sensing object properly before using the F3W-E in actual operation.

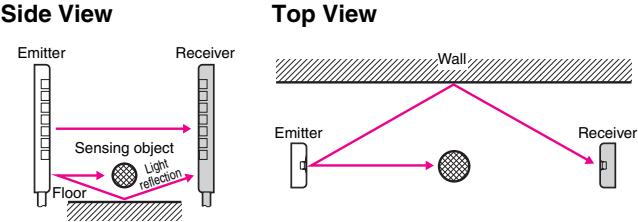

● **Adjustment**

**Operation and Stability Status Display**

- The following illustration shows the indicator status corresponding to each incident level.
- Install the Receiver so that the green stability indicators are both ON in light receiving status.

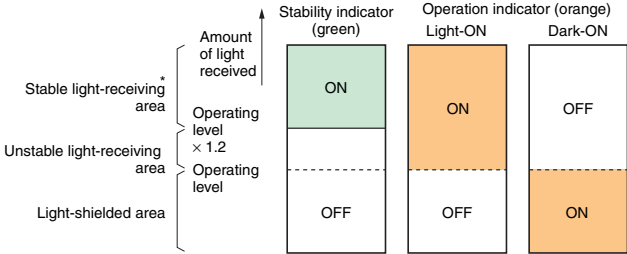

\* If the Receiver is set to the stable light-receiving area, it will become more resistant to environmental fluctuations such as temperature, voltage, dust, and setting deviation after installation. For applications where a stable light-receiving area is not obtained, attention must be paid to environmental fluctuations.



# F3W-E

## Dimensions

(Unit: mm)

### Sensors

#### F3W-E

#### Emitter

F3W-E032A6/A8-L

F3W-E032B6/B8-L

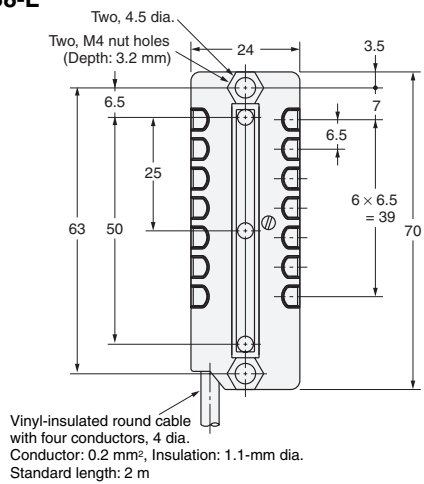

#### Mounting Hole Dimensions

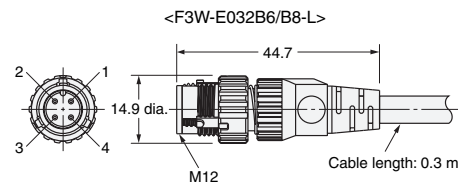
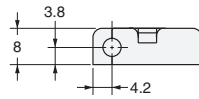
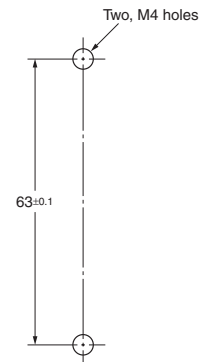

#### Receiver

F3W-E032A6/A8-D

F3W-E032B6/B8-D

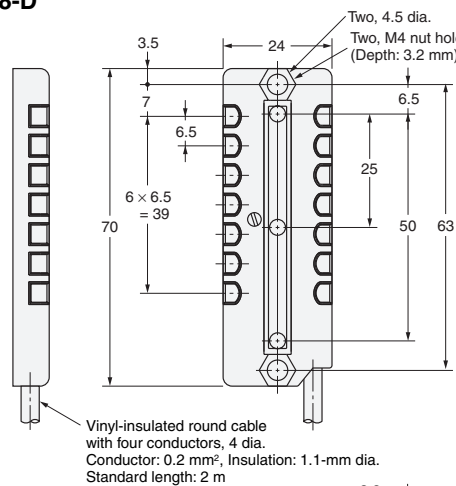

#### Mounting Hole Dimensions

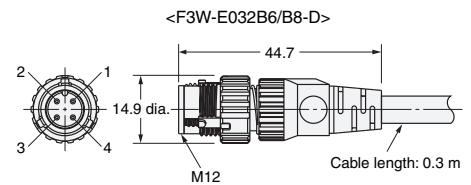
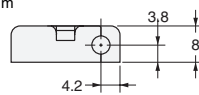
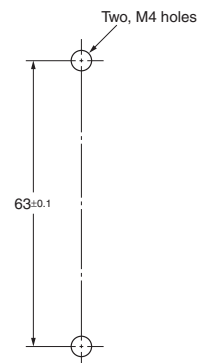

Accessories (Order Separately)

Mounting Brackets

F39-LE2 (L-shaped)



Material: Iron (Thickness: 1.5 mm)  
Mounting screws provided.

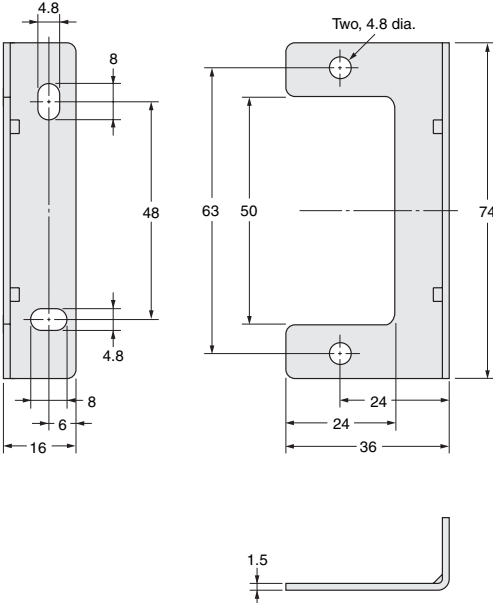

F3W-E032A-D with Mounting Bracket

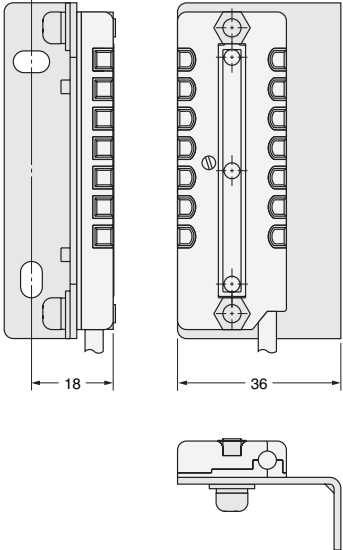

Mounting Brackets

F39-LE1 (Flat)



Material: Iron (Thickness: 1.5 mm)  
Mounting screws provided.

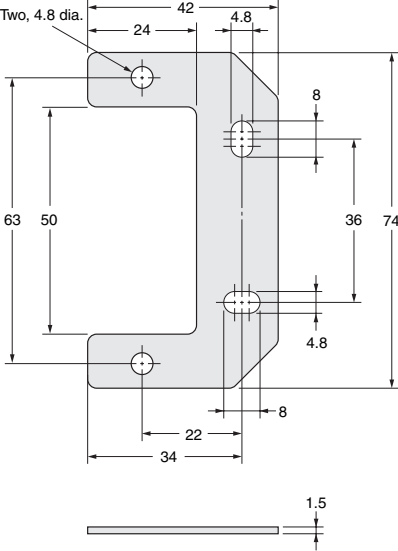

F3W-E032A-D with Mounting Bracket

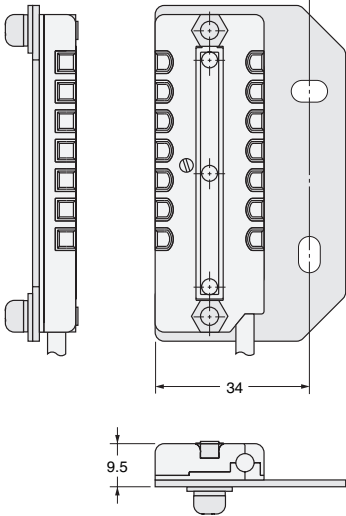

# F3W-E

## Protective Bracket

F39-LE3



Material: Iron (Thickness: 1 mm)  
Mounting screws provided.

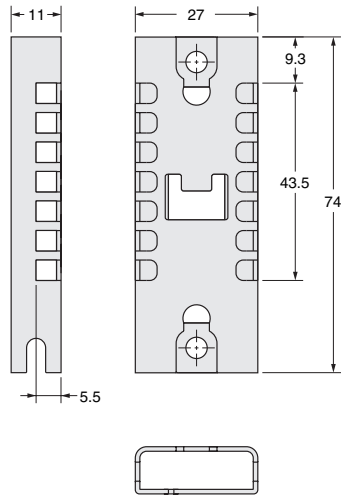

F3W-E032A□-D with Protective Bracket

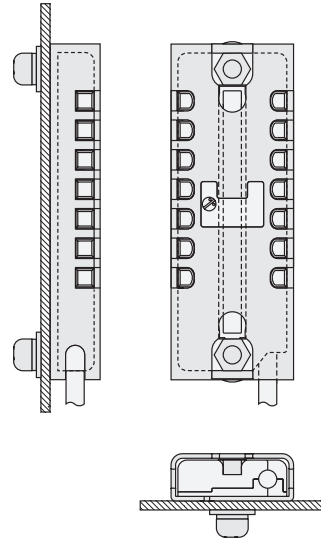

## Terms and Conditions Agreement

### Read and understand this catalog.

Please read and understand this catalog before purchasing the products. Please consult your OMRON representative if you have any questions or comments.

### Warranties.

(a) Exclusive Warranty. Omron's exclusive warranty is that the Products will be free from defects in materials and workmanship for a period of twelve months from the date of sale by Omron (or such other period expressed in writing by Omron). Omron disclaims all other warranties, express or implied.

(b) Limitations. OMRON MAKES NO WARRANTY OR REPRESENTATION, EXPRESS OR IMPLIED, ABOUT NON-INFRINGEMENT, MERCHANTABILITY OR FITNESS FOR A PARTICULAR PURPOSE OF THE PRODUCTS. BUYER ACKNOWLEDGES THAT IT ALONE HAS DETERMINED THAT THE PRODUCTS WILL SUITABLY MEET THE REQUIREMENTS OF THEIR INTENDED USE.

Omron further disclaims all warranties and responsibility of any type for claims or expenses based on infringement by the Products or otherwise of any intellectual property right. (c) Buyer Remedy. Omron's sole obligation hereunder shall be, at Omron's election, to (i) replace (in the form originally shipped with Buyer responsible for labor charges for removal or replacement thereof) the non-complying Product, (ii) repair the non-complying Product, or (iii) repay or credit Buyer an amount equal to the purchase price of the non-complying Product; provided that in no event shall Omron be responsible for warranty, repair, indemnity or any other claims or expenses regarding the Products unless Omron's analysis confirms that the Products were properly handled, stored, installed and maintained and not subject to contamination, abuse, misuse or inappropriate modification. Return of any Products by Buyer must be approved in writing by Omron before shipment. Omron Companies shall not be liable for the suitability or unsuitability or the results from the use of Products in combination with any electrical or electronic components, circuits, system assemblies or any other materials or substances or environments. Any advice, recommendations or information given orally or in writing, are not to be construed as an amendment or addition to the above warranty.

See <http://www.omron.com/global/> or contact your Omron representative for published information.

### Limitation on Liability; Etc.

OMRON COMPANIES SHALL NOT BE LIABLE FOR SPECIAL, INDIRECT, INCIDENTAL, OR CONSEQUENTIAL DAMAGES, LOSS OF PROFITS OR PRODUCTION OR COMMERCIAL LOSS IN ANY WAY CONNECTED WITH THE PRODUCTS, WHETHER SUCH CLAIM IS BASED IN CONTRACT, WARRANTY, NEGLIGENCE OR STRICT LIABILITY.

Further, in no event shall liability of Omron Companies exceed the individual price of the Product on which liability is asserted.

### Suitability of Use.

Omron Companies shall not be responsible for conformity with any standards, codes or regulations which apply to the combination of the Product in the Buyer's application or use of the Product. At Buyer's request, Omron will provide applicable third party certification documents identifying ratings and limitations of use which apply to the Product. This information by itself is not sufficient for a complete determination of the suitability of the Product in combination with the end product, machine, system, or other application or use. Buyer shall be solely responsible for determining appropriateness of the particular Product with respect to Buyer's application, product or system. Buyer shall take application responsibility in all cases.

NEVER USE THE PRODUCT FOR AN APPLICATION INVOLVING SERIOUS RISK TO LIFE OR PROPERTY OR IN LARGE QUANTITIES WITHOUT ENSURING THAT THE SYSTEM AS A WHOLE HAS BEEN DESIGNED TO ADDRESS THE RISKS, AND THAT THE OMRON PRODUCT(S) IS PROPERLY RATED AND INSTALLED FOR THE INTENDED USE WITHIN THE OVERALL EQUIPMENT OR SYSTEM.

### Programmable Products.

Omron Companies shall not be responsible for the user's programming of a programmable Product, or any consequence thereof.

### Performance Data.

Data presented in Omron Company websites, catalogs and other materials is provided as a guide for the user in determining suitability and does not constitute a warranty. It may represent the result of Omron's test conditions, and the user must correlate it to actual application requirements. Actual performance is subject to the Omron's Warranty and Limitations of Liability.

### Change in Specifications.

Product specifications and accessories may be changed at any time based on improvements and other reasons. It is our practice to change part numbers when published ratings or features are changed, or when significant construction changes are made. However, some specifications of the Product may be changed without any notice. When in doubt, special part numbers may be assigned to fix or establish key specifications for your application. Please consult with your Omron's representative at any time to confirm actual specifications of purchased Product.

### Errors and Omissions.

Information presented by Omron Companies has been checked and is believed to be accurate; however, no responsibility is assumed for clerical, typographical or proofreading errors or omissions.

2013.12

In the interest of product improvement, specifications are subject to change without notice.

**OMRON Corporation**  
Industrial Automation Company

<http://www.ia.omron.com/>

(c)Copyright OMRON Corporation 2013 All Right Reserved.