

Monitor the Output of a UV Light Source through an Optical Fiber Cable

- Head Unit withstands temperatures of up to 300°C.
- Easy-to-read digital display of measurement values.
- Harmful UV light converted to visible light before performing measurements. This feature prevents deterioration of the Amplifier's light receiving element.



Ordering Information



Amplifier

Appearance	Connection method	Outputs	Transistor type	Model number
	Pre-wired cable (2 m)	<ul style="list-style-type: none"> • Judgement output • Answer-back output • Analog current or voltage output 	NPN	F3UV-XW11
				F3UV-XW11-1 (Five-times higher sensitivity)
			PNP	F3UV-XW41

Head Unit

Appearance	Wavelength range of incident light	Max. temperature	Model number	Remarks
	200 to 370 nm	300°C (Use at temperatures below the Fiber Unit's rated operating temperature.)	F3UV-HM	Includes two M8 nuts and one mounting plate.

Fiber Units

Compatible Amplifier Units	Compatible Head Units	Appearance	Max. temperature	Intensity range of incident light (see note)	Model number	Quantity
F3UV-XW11 (-1), F3UV-XW41	F3UV-HM	 M4 threads, 2 m	300°C	10 to 300 mW/cm ²	F32-300 2M	1
		 M4 threads, 2 m	70°C	10 to 300 mW/cm ²	F32-70	

Note: The values given are for a standard UV light source with a central wavelength of 360 nm, measured with a standard illumination meter (and for use in combination with the specified Amplifier and Head Unit). The power range is one for which teaching to 100% is possible.

■ Accessories (Sold Separately)

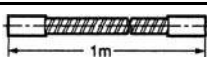
Appearance	Name	Model number	Quantity	Applicable Fiber Units
	Protective Tube (Protects the fiber.)	F39-FU1M	1	F32-70

Specifications

■ Ratings/Characteristics

Amplifiers

Item		F3UV-XW11 (-1)	F3UV-XW41
Power supply voltage		12 to 24 VDC $\pm 10\%$	
Current consumption		75 mA max.	
Outputs	Analog output	Current (4 to 20 mA) or voltage (1 to 5 V) (Monitoring mode or integral mode)	
	Judgement output	NPN open collector output, 100 mA max., residual voltage 1 V max. (Monitoring mode or integral mode)	PNP open collector output, 100 mA max., residual voltage 2 V max. (Monitoring mode or integral mode)
	Answer-back output		
Inputs	Remote teaching input	ON: 0 V short-circuit (current 1 mA max.)	ON: Power supply voltage short-circuit or 9 to 24 V (open-circuit current: 3 mA max.) OFF: Open (open or 1.5 V max.)
	Reset input	OFF: Open (open or 9 to 24 V)	
Protective circuits		Reversed power supply polarity protection and output short-circuit protection	
Response time ¹		500 ms max.	
Sensitivity setting		Teaching function	
Indicators		Power supply/Teaching indicator (green/red), Operation indicator (orange), 7-segment digital percentage display (red), 7-segment digital threshold display (red)	
Repetitive accuracy		$\pm 2\%$ F.S. max.	
Ambient operating illumination ²		Fluorescent light 1,000 lx max.	
Temperature drift		$\pm 0.1\%$ of F.S./ $^{\circ}\text{C}$ max.	
Ambient temperature		Operating: -25 to 55°C (with no icing or condensation) Storage: -40 to 70°C (with no icing or condensation)	
Ambient humidity		Operating or storage: 35% to 85%	
Insulation resistance		20 M Ω min. (at 500 VDC)	
Dielectric strength		1,000 V AC 50/60 Hz between the leads and the case	
Vibration resistance		10 to 150 Hz, 0.1-mm amplitude or 15 m/s ² in X, Y, and Z directions each for 2 hours	
Shock resistance		150 m/s ² three times each in the X, Y, and Z directions	
Degree of protection		Conforms to IEC 60529 standards IP30	
Connection method		Pre-wired cable with a standard length of 2 m	
Weight (packed)		Approx. 270 g	
Material		ABS plastic	
Accessories		Operation Manual	

- Note:**
1. The response time is the rise time or fall time of the output signal to 10 to 90%.
 2. The ambient operating illumination is the illumination that changes the analog output $+5\%$ F.S. at 200 lx; it is not the operational limit.
 3. An analog output of up to 6 V (or 24 mA) can be output. The output is 1 V (or 4 mA) when there is no incident UV light.
 4. F.S. stands for full scale. For a current output, full scale is 16 mA (4 to 20 mA). For a voltage output, full scale is 4 V (1 to 5 V).
 5. Definition of the luminous energy integral: The physical unit of the luminous energy integral is energy (J: joules) and this value is calculated by multiplying the UV intensity (mV) by the time of exposure (s), but it is dimensionless when this sensor's analog output value (V) is used for the UV intensity. The integral is measured with an 11 ms sampling time.

Head Unit

Item		F3UV-HM
Incident light wavelength range		200 to 370 nm
Temperature drift		-0.15% / $^{\circ}\text{C}$ max.
Ambient temperature		Operating or storage: -40° to 300°C (with no icing or condensation)
Ambient humidity		Operating or storage: 35% to 85% (with no icing or condensation)
Weight (packed)		Approx. 300 g
Vibration resistance		10 to 55 Hz, 0.75-mm amplitude or 10 m/s ²
Shock resistance		500 m/s ²
Material	Protective casing	Stainless steel (SUS303)
	Fluorescent fiber path	Functional fluoroglass
Accessories		M8 nut and mounting bracket

Fiber Units

Item	Model	
	F32-300	F32-70
Ambient temperature (with no icing or condensation)	Operating: -40° to 300°C*1 Storage: -40° to 110°C	Operating: -40° to 70°C Storage: -40° to 70°C
Ambient humidity (with no icing or condensation)	Operating: 35 to 85% Storage: 35 to 95%	
Bending radius	25 mm min.	25 mm min.
Fiber outer sheathing material	SUS	Black polyethylene
Degree of protection	Conforms to IEC IP67	
Standard fiber length	2 m	

Note: The maximum temperature is lower near the amplifier unit. See the Dimensions for details.

Accessories (Sold Separately)

Protective Tube (Protects the Fiber.)

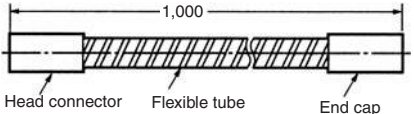
Item	F39-FU1M	
	 <p>The diagram shows a cross-section of the protective tube assembly. It consists of a head connector on the left, a central flexible tube with a length of 1,000 units, and an end cap on the right. The flexible tube is shown with diagonal hatching to indicate its flexibility.</p>	
Ambient temperature	-40° to 150°C for operation and storage (Keep the ambient temperature within the range specified for the fiber within the tube.)	
Ambient humidity	Operating: 35 to 85% Storage: 35 to 95%	
Bending radius	30 mm min.	
Max. pulling force	1.5 N·m max. between the head connector and tube, 1.5 N·m max. between the end cap and tube, and 2 N·m on the tube itself	
Crush weight	29.4 N·m max. on the tube	
Material	Head connector	Nickel-plated brass
	End cap	
	Tube	Stainless (SUS304)

Engineering Data (Reference Value)

Output Characteristics

F3UV-XW□1 + F3UV-HM + F32-300

(Output characteristics when the sensitivity is set at 300 mW/cm².)

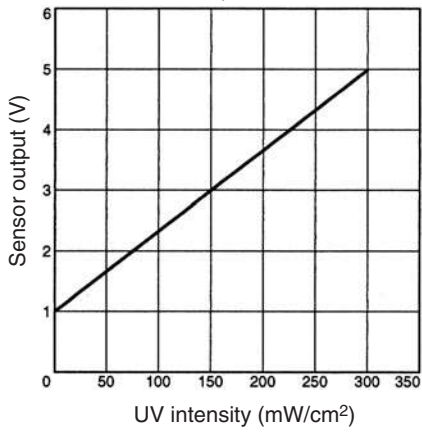

Angular Characteristics (Y-direction)

F3UV-HM

The output variation in the X-direction is less than ±10% of F.S. in a full 360° rotation.

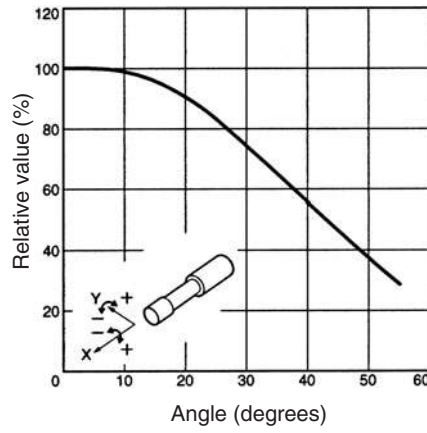

Output Characteristics

F3UV-XW11-1 + F3UV-HM + F32-70

(Output characteristics when the output is set at 5V for a UV intensity of 60 mW/cm².)

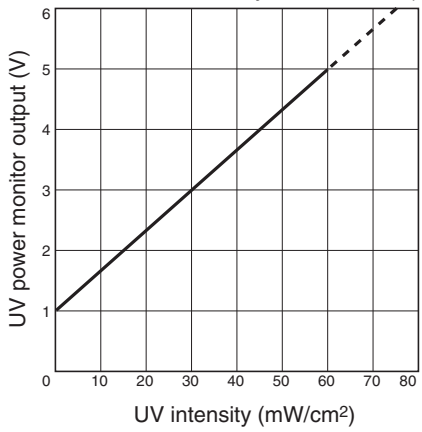

Sensitivity Characteristics

All F3UV Models

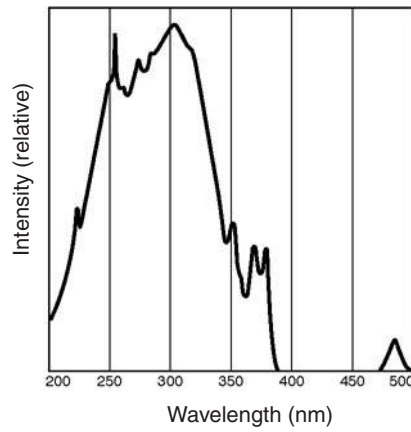

Nomenclature

F3UV-XW11 (-1) /-XW41

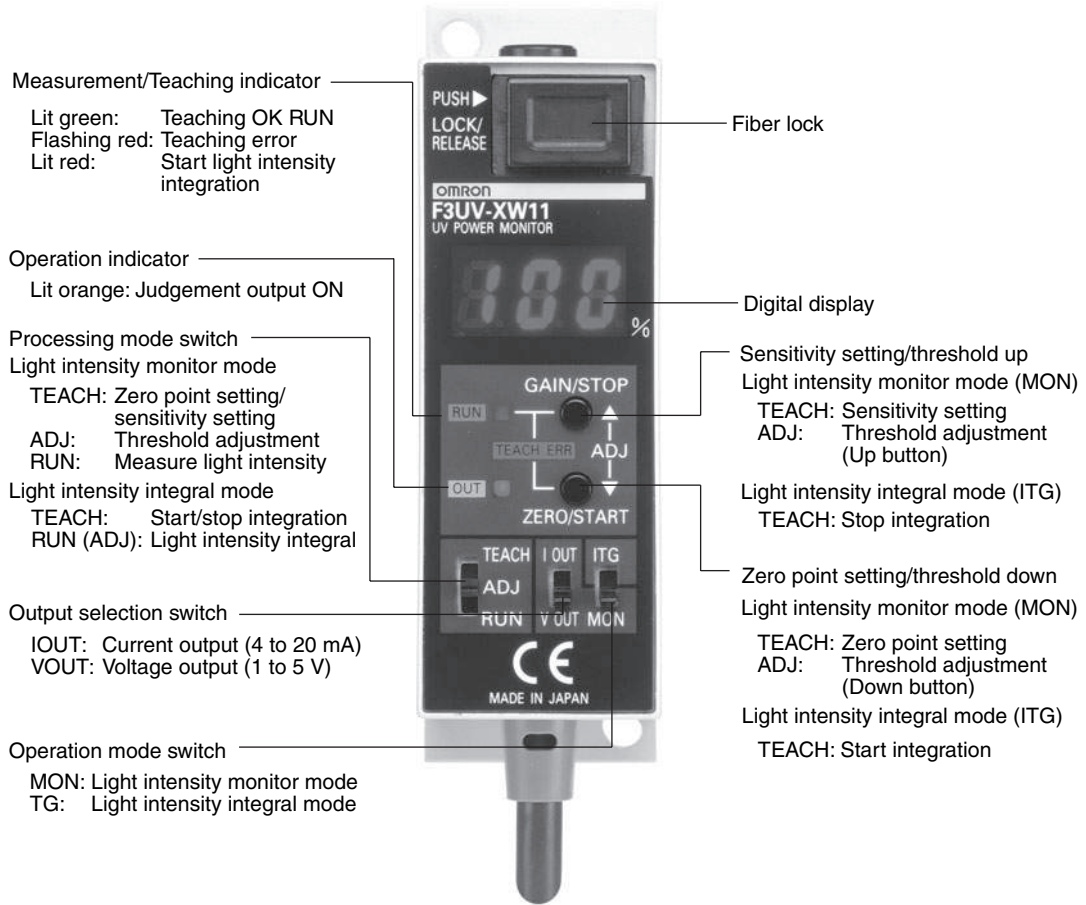

Functions

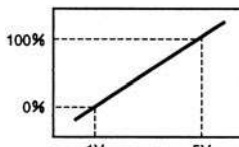
Name	Function
Indicator functions	
Measurement/teaching indicator	<ul style="list-style-type: none"> • Lit green: Teaching OK RUN • Flashing red: Teaching error • Lit red: Start light intensity integration
Operation indicator	<ul style="list-style-type: none"> • Lit orange: Judgement output ON
Digital display	<ul style="list-style-type: none"> • Percentage display when operating in light intensity monitor mode HI: Greater than 124% LO: Less than 0%
Output functions	
Analog output (switchable)	<ul style="list-style-type: none"> • Outputs a current (4 to 20 mA) or voltage (1 to 5 V) that is proportional to the incident light intensity. Select current or voltage output with the output selection switch.
Judgement output	<ul style="list-style-type: none"> • ON when the incident light intensity is below the set threshold value. • OFF when the incident light intensity is above the set threshold value. (Includes a short-circuit protection function.)
Answer-back output	<ul style="list-style-type: none"> • A one pulse output (1 sec) is generated when remote teaching has been completed normally.
Input functions	
Reset input	<ul style="list-style-type: none"> • This trigger signal starts integration when the Unit is in integral mode and the processing mode is set to "RUN".
Remote teaching input	<ul style="list-style-type: none"> • When the Unit is in monitor mode or integral mode, teaching is performed when a pulse signal is input here.
Threshold setting function (monitor mode only)	<ul style="list-style-type: none"> • The desired threshold value can be set by pressing the Up and Down buttons. (The digital display will change in 1% increments when the value is set.)
Sensitivity setting function (monitor mode only)	
Zero point setting	<ul style="list-style-type: none"> • Sets the zero point reference when the UV light source is OFF. After teaching, the digital display will read "0%".
Sensitivity setting	<ul style="list-style-type: none"> • Sets the initial sensitivity when the UV light source is ON. After teaching, the digital display will read "100%".
Max. sensitivity setting	<ul style="list-style-type: none"> • Sets the sensor sensitivity to the maximum sensitivity.
Min. sensitivity setting	<ul style="list-style-type: none"> • Sets the sensor sensitivity to the minimum sensitivity.
Light intensity monitor function (Part of the current/voltage output switching function.)	<ul style="list-style-type: none"> • Displays the digital (%) value corresponding to the incident light intensity and outputs the analog and judgement outputs. <div style="text-align: center; margin: 10px 0;">  </div>
Light intensity integral function (Part of the current/voltage output switching function.)	<ul style="list-style-type: none"> • Calculates the light intensity integral value (I) from the incident light intensity (P) and time (T) using the following equation: $I = P \times T$. Also outputs the integral's analog output simultaneously and displays the digital (%) value. (Output ON at 100%.)

Operation

I/O Circuit Configuration

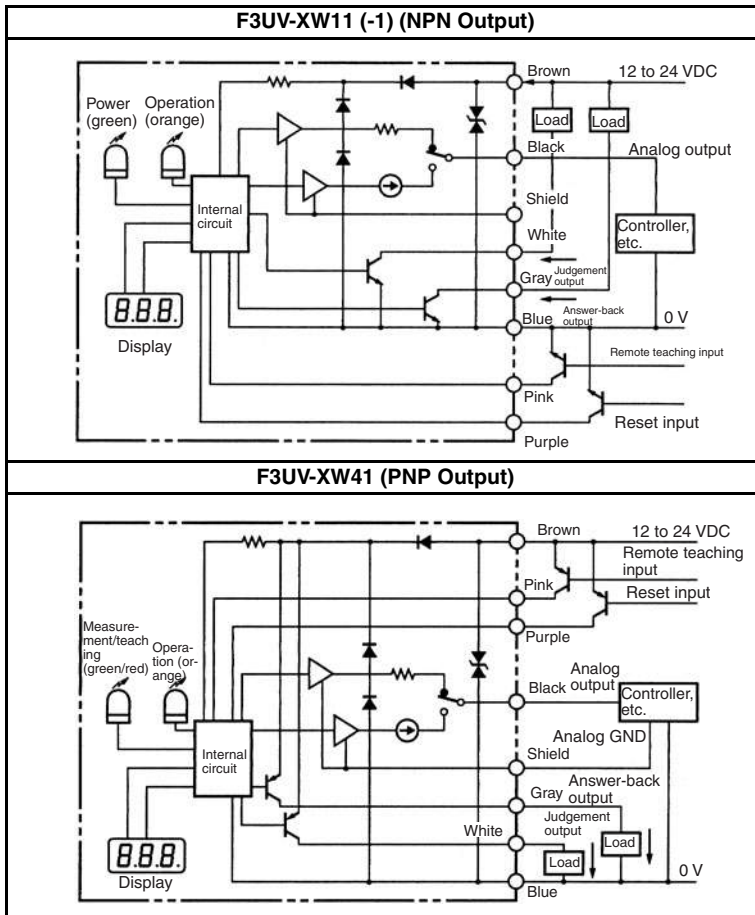

Dimensions

Note: All units are in millimeters unless otherwise indicated.

Main Units

Amplifier

F3UV-XW11 (-1) /-XW41

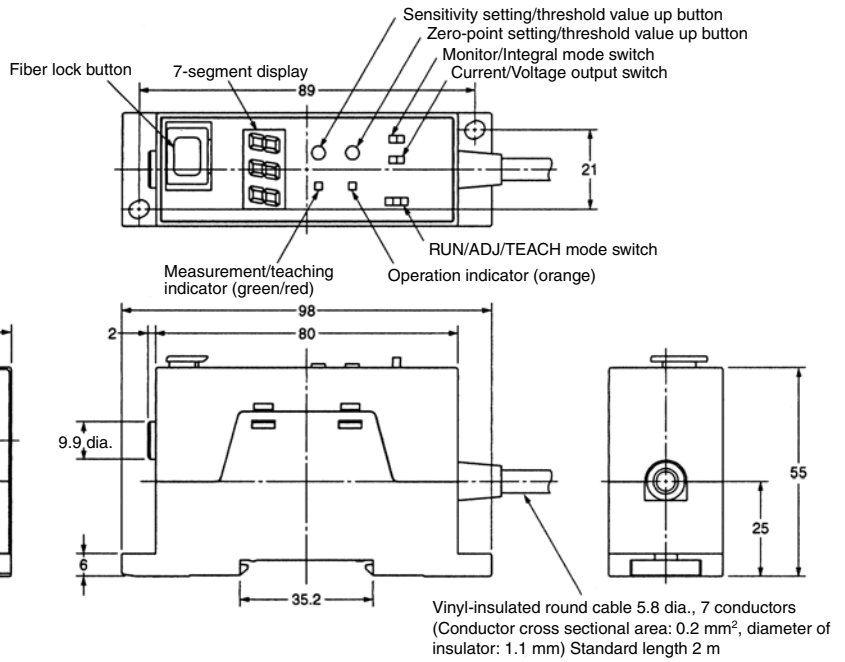
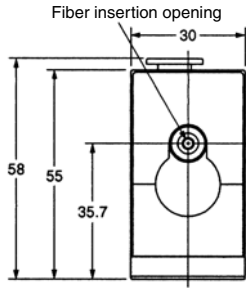
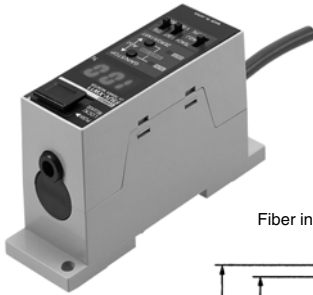

Mounting Hole Dimensions

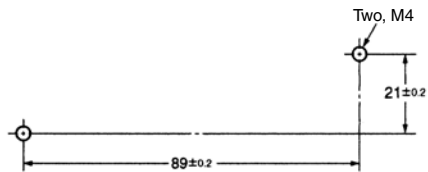

**Base Unit
F3UV-HM**

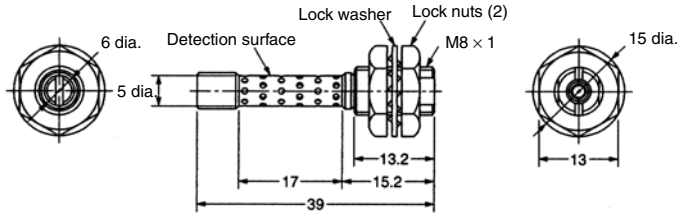

Material: Stainless steel (SUS303)

**Fiber Unit
F32-300**

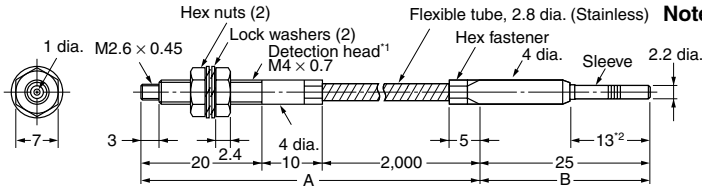

Note: The max. temperature is 300°C in section A and 110°C in section B, which connects to the Main Unit. The part of section B that is actually inserted into the Main Unit must remain within the Main Unit's rated operating temperature range.

*1: Material: Stainless steel (SUS303)

**Fiber Unit
F32-70 (Cuttable)**

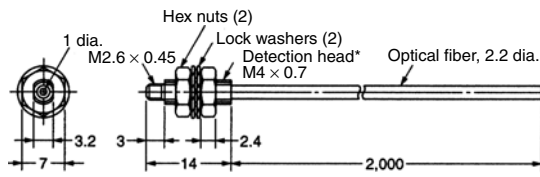

*Material: Nickel-plated brass

Note: The "cuttable" Fiber Units can be cut to length. Units that are not marked "cuttable" cannot be cut to length.

Accessories (Sold Separately)

**Protective Tube (Protects the Fiber.)
F32-FU1M**

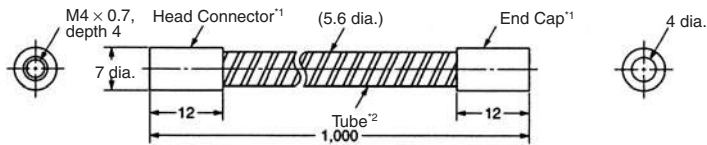

Note: 1. Material: Nickel-plated brass
2. Material: Stainless steel (SUS304)

Precautions

Be sure to observe the precautions listed here. These precautions are essential for safe operation.

- Do not use these Units in locations with flammable or explosive gases.
- Do not use these Units in water.
- Do not attempt to disassemble, repair, or improve these products.
- Always use a power supply voltage that is within the specified operating range. Do not use with an AC power supply.

- Be sure that wiring is correct, such as the polarity of the power supply leads.
- Connect loads properly.
- Do not short-circuit the load's terminals.
- Do not mount the Amplifier Unit in a location where it will be exposed to UV light.

■ Precautions Common to the Amplifiers

Wiring

Connections

Make sure that the power supply voltage is below the maximum voltage before turning the power ON.

Be sure that the terminal polarity and wiring are correct.

Never share a conduit that is used for high-voltage or power lines.

Use extension cords with a minimum thickness of 0.3 mm², less than 5 m long, and check operation before using.

Power Supply

When using a commercial switching regulator, ground the FG (frame ground) and G (ground) terminals. Output signal noise will be excessive if the power supply is not grounded.

After turning on the power supply, wait for at least one second until consistent detections can be performed before using the Monitor. If separate power supplies are used for the F3UV and connected devices, always turn ON the F3UV's power supply first.

Installation and Operation

Installation

UV light is harmful, so be sure to turn OFF the UV light source before installing the F3UV.

Sensitivity Setting

The analog output value will change due to temperature drift. If the temperature is rising, wait for the temperature to stabilize before setting the sensitivity.

Installation

1. Installation Torque

Torque the sensor's Main Unit screws to 0.49 N·m max.

2. Using DIN Track (Installation)

1. Hook the top of the Unit onto the DIN Track.
2. Snap the bottom of the Unit onto the DIN Track.

Note: Do not reverse steps 1 and 2.

(Removal)

When removing the Unit from the DIN Track, pull the mounting hook forward to release it.

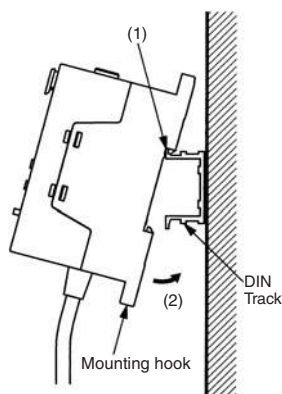

Precautions Regarding UV Light

The Amplifier itself is not protected against UV exposure. Do not install the Amplifier in locations where it will be exposed to UV light.

Adjustment

Basic Operating Procedures

1. Install the Amplifier Unit.
2. Connect the Fiber Unit to the Amplifier Unit.
3. Turn ON the power supply.
4. Select an operating mode with the operation mode switch. (Light intensity monitor mode or light intensity integral mode)
5. When using the analog output, select current or voltage output with the output selection switch.
6. Set the processing mode switch to TEACH and perform the teaching operation.
 - Light Intensity Monitor Mode
Make the zero-point setting when the indicator is not lit and make the sensitivity setting when the indicator is lit. (Make the sensitivity setting after the temperature has stabilized.)
 - Light Intensity Integral Mode
Use the start setting at the start of illumination and the stop setting when completed. Teaching can be performed by pressing the buttons or with codes.
7. When changing the threshold value in light intensity monitor mode, set the processing mode switch to ADJ and adjust the threshold value. The judgement output will go ON when the light intensity is below the threshold value. The threshold value is set to 50 at the factory.
8. Set the processing mode switch to RUN to start measurement. In light intensity integral mode, start integration with the Reset input.

Cleaning

Never use paint thinner or mineral spirits of any kind.

■ Fiber Unit/Base Unit

Installation

Installing the Head Unit

When connecting the Head Unit and Fiber Unit, tighten to a torque of 0.78 N·m max. When installing the Head Unit, be sure to turn OFF the UV light source and check that it is safe to install the Unit.

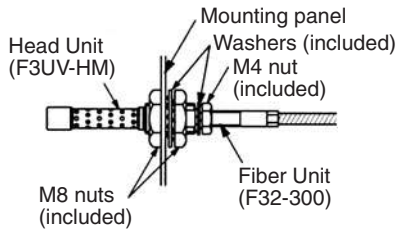

Installing the Fiber Unit and Amplifier Unit

The quality of the connection between the Fiber Unit and Amplifier Unit has a major impact on the operating characteristics, so be sure to connect these Units securely.

Securing the Fiber Unit

1. Cutting the Fiber (F32-70 only)
 - Insert the fiber into the hole of the cutting tool and set the tool at the desired length.
 - Press down on the blade and cut the fiber. Do not stop when the fiber is only partially cut; make one clean cut.
 - Once a hole has been used to cut a fiber, do not use that hole again. The cut surface may not be clean enough and the detection characteristics may be degraded.
2. Installing the Fiber

With the lock button in the release position, insert the fiber into the Unit and press the button until you hear a click. This click is the sound of the fiber being locked.

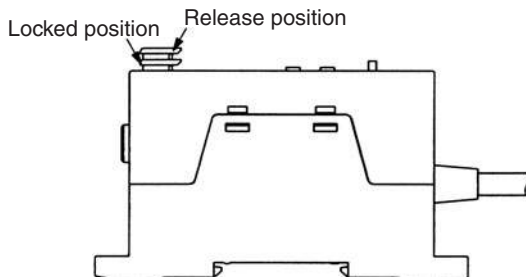

3. Removing the Fiber

Press the lock button again. The lock will be released, the lock button will pop up, and it will be possible to remove the fiber. Do not force the lock button up by pulling on it. (To maintain the fiber's characteristics, check whether the lock is out of place.)
4. Fiber Insertion Location

When inserting the Fiber Unit into the Amplifier Unit, always insert the Fiber Unit completely as shown in the following diagram.

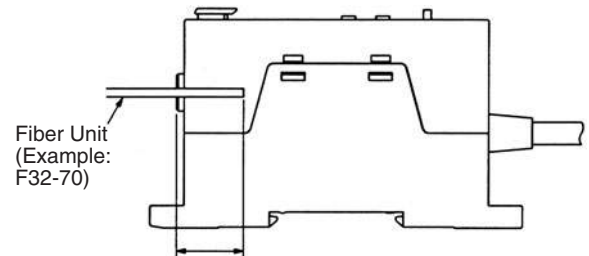
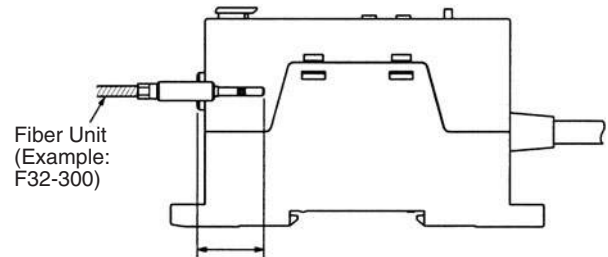

5. Fiber Unit Installation/Removal Precautions

Install and remove the Fiber Unit only when the ambient temperature is between -40 and 40°C .
6. Protecting the Fiber Unit

When the outer sheathing of a Fiber Unit other than the F32-300 will be exposed to UV light, protect the fiber by covering it with the F39-FU1M Protective Tube.

ALL DIMENSIONS SHOWN ARE IN MILLIMETERS.

To convert millimeters into inches, multiply by 0.03937. To convert grams into ounces, multiply by 0.03527.

CSM_F3UV_DS_E_5_1
E315-E1

In the interest of product improvement, specifications are subject to change without notice.

OMRON Corporation

Industrial Automation Company

Sensing Devices Division H.Q.
Application Sensors Division

Shiokoji Horikawa, Shimogyo-ku,
Kyoto, 600-8530 Japan

Tel: (81)75-344-7068/Fax: (81)75-344-7107

Terms and Conditions Agreement

Read and understand this catalog.

Please read and understand this catalog before purchasing the products. Please consult your OMRON representative if you have any questions or comments.

Warranties.

(a) Exclusive Warranty. Omron's exclusive warranty is that the Products will be free from defects in materials and workmanship for a period of twelve months from the date of sale by Omron (or such other period expressed in writing by Omron). Omron disclaims all other warranties, express or implied.

(b) Limitations. OMRON MAKES NO WARRANTY OR REPRESENTATION, EXPRESS OR IMPLIED, ABOUT NON-INFRINGEMENT, MERCHANTABILITY OR FITNESS FOR A PARTICULAR PURPOSE OF THE PRODUCTS. BUYER ACKNOWLEDGES THAT IT ALONE HAS DETERMINED THAT THE PRODUCTS WILL SUITABLY MEET THE REQUIREMENTS OF THEIR INTENDED USE.

Omron further disclaims all warranties and responsibility of any type for claims or expenses based on infringement by the Products or otherwise of any intellectual property right. (c) Buyer Remedy. Omron's sole obligation hereunder shall be, at Omron's election, to (i) replace (in the form originally shipped with Buyer responsible for labor charges for removal or replacement thereof) the non-complying Product, (ii) repair the non-complying Product, or (iii) repay or credit Buyer an amount equal to the purchase price of the non-complying Product; provided that in no event shall Omron be responsible for warranty, repair, indemnity or any other claims or expenses regarding the Products unless Omron's analysis confirms that the Products were properly handled, stored, installed and maintained and not subject to contamination, abuse, misuse or inappropriate modification. Return of any Products by Buyer must be approved in writing by Omron before shipment. Omron Companies shall not be liable for the suitability or unsuitability or the results from the use of Products in combination with any electrical or electronic components, circuits, system assemblies or any other materials or substances or environments. Any advice, recommendations or information given orally or in writing, are not to be construed as an amendment or addition to the above warranty.

See <http://www.omron.com/global/> or contact your Omron representative for published information.

Limitation on Liability; Etc.

OMRON COMPANIES SHALL NOT BE LIABLE FOR SPECIAL, INDIRECT, INCIDENTAL, OR CONSEQUENTIAL DAMAGES, LOSS OF PROFITS OR PRODUCTION OR COMMERCIAL LOSS IN ANY WAY CONNECTED WITH THE PRODUCTS, WHETHER SUCH CLAIM IS BASED IN CONTRACT, WARRANTY, NEGLIGENCE OR STRICT LIABILITY.

Further, in no event shall liability of Omron Companies exceed the individual price of the Product on which liability is asserted.

Suitability of Use.

Omron Companies shall not be responsible for conformity with any standards, codes or regulations which apply to the combination of the Product in the Buyer's application or use of the Product. At Buyer's request, Omron will provide applicable third party certification documents identifying ratings and limitations of use which apply to the Product. This information by itself is not sufficient for a complete determination of the suitability of the Product in combination with the end product, machine, system, or other application or use. Buyer shall be solely responsible for determining appropriateness of the particular Product with respect to Buyer's application, product or system. Buyer shall take application responsibility in all cases.

NEVER USE THE PRODUCT FOR AN APPLICATION INVOLVING SERIOUS RISK TO LIFE OR PROPERTY OR IN LARGE QUANTITIES WITHOUT ENSURING THAT THE SYSTEM AS A WHOLE HAS BEEN DESIGNED TO ADDRESS THE RISKS, AND THAT THE OMRON PRODUCT(S) IS PROPERLY RATED AND INSTALLED FOR THE INTENDED USE WITHIN THE OVERALL EQUIPMENT OR SYSTEM.

Programmable Products.

Omron Companies shall not be responsible for the user's programming of a programmable Product, or any consequence thereof.

Performance Data.

Data presented in Omron Company websites, catalogs and other materials is provided as a guide for the user in determining suitability and does not constitute a warranty. It may represent the result of Omron's test conditions, and the user must correlate it to actual application requirements. Actual performance is subject to the Omron's Warranty and Limitations of Liability.

Change in Specifications.

Product specifications and accessories may be changed at any time based on improvements and other reasons. It is our practice to change part numbers when published ratings or features are changed, or when significant construction changes are made. However, some specifications of the Product may be changed without any notice. When in doubt, special part numbers may be assigned to fix or establish key specifications for your application. Please consult with your Omron's representative at any time to confirm actual specifications of purchased Product.

Errors and Omissions.

Information presented by Omron Companies has been checked and is believed to be accurate; however, no responsibility is assumed for clerical, typographical or proofreading errors or omissions.

2015.7

In the interest of product improvement, specifications are subject to change without notice.

OMRON Corporation
Industrial Automation Company

<http://www.ia.omron.com/>

(c)Copyright OMRON Corporation 2015 All Right Reserved.