

E3X-DAC-S

Easy and Reliable

The Fiber Amplifier Unit That Sees in Color

- High-power white LED and multi-RGB processing eliminate the need to select light source (wavelength) types.
- One-touch teaching enables stable detection that resists against workpiece vibration.
- Choose from a wide range of Fiber Heads to match the workpiece and working space.



Refer to *Safety Precautions* on page 10.

Features

Easy and Reliable ... Featuring a Color-sensing Engine

A high-power white LED and a multi-RGB processing system combine to cover all RGB wavelengths, enabling easy and accurate detection of workpieces without having to use a different light source to watch each one.

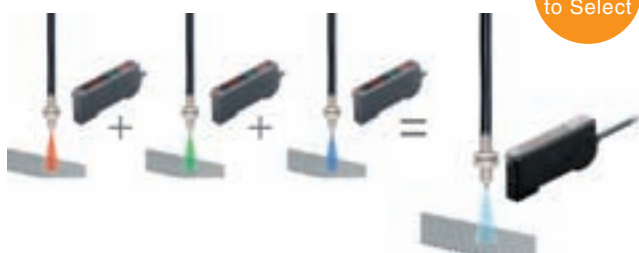

No Need to Select

Colors are detected through changes in the ratio of three parameters, RGB, to enable stable detection even when the workpiece moves.

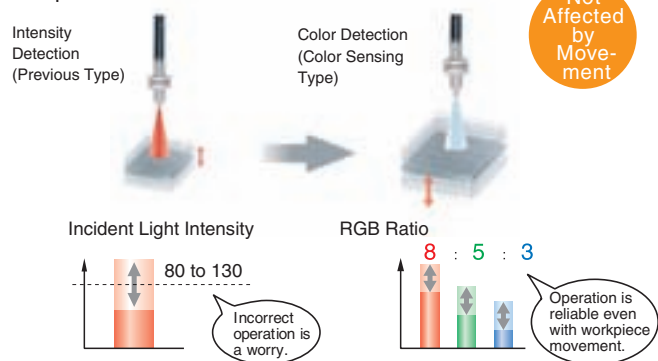

Easy and Reliable ... Ease of Use and Smart Functions

In addition to ensuring easy use, we have added a number of smart functions, such as remote control to simplify setup, and twin sensing and output to simultaneously distinguish two registered colors. (advanced models)

Wide Range of Fiber Heads Available
Select from a wide range of Fiber Heads to match the workpiece and working space.



Easy-to-Understand Double Display
Immediately check the degree of match with the registered colors and the thresholds or easily make fine adjustment while checking these values.

First in Its Class

Reliable Setting guide function.
This function guides the user to ensure that the workpiece is in an appropriate position for teaching. (Indicates OVER, OK, or LOW.)

Easy Setting with One-push Teaching
Settings to teach the workpiece to be detected can be easily performed with one push.

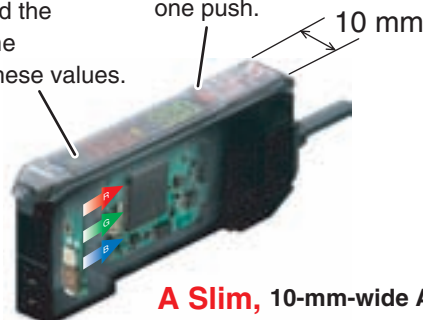

A Slim, 10-mm-wide Amplifier
Use of a white LED and a one-package RGB light-receiving element results in a slim Amplifier.

Ordering Information

Fiber Amplifier Unit

Pre-wired Amplifier Units [Refer to Dimensions on page 13.]

Item	Appearance	Functions	Model	
			NPN output	PNP output
Standard models		Timer, Response speed change	E3X-DAC11-S 2M	E3X-DAC41-S 2M
Advanced models with simultaneous 2-color determination		Standard models + Simultaneous 2-color determination AND/OR output, Remote setting	E3X-DAC21-S 2M	E3X-DAC51-S 2M
Advanced models with 4-color determination *		Standard model + 4-color determination AND/OR output, Bank switching	E3X-DAC21B-S 2M	E3X-DAC51B-S 2M

*Four-color determination is enabled by using an external input to switch between banks for two outputs.

Amplifier Units with Connectors (Amplifier Unit Connectors must be ordered separately.) [Refer to Dimensions on page 15.]

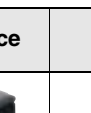
Item	Appearance	Functions	Model	
			NPN output	PNP output
Standard models		Timer, Response speed change	E3X-DAC6-S	E3X-DAC8-S

Accessories (Order Separately)

Amplifier Units Connectors (Required for models for Wire-saving Connectors.)

Note: Protector seals are provided as accessories. [Refer to Dimensions on page 15.]

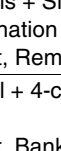
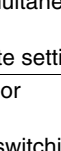
Item	Appearance	Cable length	No. of conductors	Model
Master Connector		2 m	3	E3X-CN11
Slave Connector			1	E3X-CN12

Ordering Precautions for Amplifier Units with Connectors

A Connector is not provided with the Amplifier Unit. Refer to the tables at the right when placing an order.

Fiber Amplifier Units			Applicable Connector (Order Separately)	
Model	NPN output	PNP output	Master Connector	Slave Connector
Standard models	E3X-DAC6-S	E3X-DAC8-S	E3X-CN11	E3X-CN12

When Using 5 Amplifier Units

Fiber Amplifier Units (5 Units)	+	1 Master Connector	4 Slave Connectors
---------------------------------	---	--------------------	--------------------

Mounting Bracket

A Mounting Bracket is not provided with the Fiber Amplifier Unit. Order a Mounting Bracket separately if required. [Refer to E39-L/F39-L/E39-S/E39-R.]

Appearance	Model	Quantity
	E39-L143	1

End Plate

End Plates are not provided with the Fiber Amplifier Unit. Order End Plates separately if required. [Refer to PFP-□.]

Appearance	Model	Quantity
	PFP-M	1

Ratings and Specifications

Fiber Amplifier Units

Type		Standard models	Advanced models with simultaneous 2-color determination	Advanced models with 4-color determination
Item	Model	E3X-DAC□-S□ (□: 11/41/6/8)	E3X-DAC□-S (□: 21/51)	E3X-DAC□B-S (□: 21/51)
Sensing distance		Depends on the Fiber Unit. Refer to page 5 to 7 for details.		
	Sensing object	Reflective models: Standard 11 color cards *1, Through-beam models: Opaque or translucent object		
Light source (wavelength)		White LED (420 to 700 nm)		
Sensing method		C Mode: RGB ratio determination (or I Mode: Light intensity determination for red, green, or blue; Black Mode: Determination of total light intensity for red, green, and blue) *2		
	Number of registered colors	1	2 (simultaneous determination)	4 (2-color simultaneous determination × 2 banks)
Power supply voltage		12 to 24 VDC ±10%, ripple (p-p) 10% max.		
Power consumption		960 mW max. (current consumption: 40 mA max. at power supply voltage of 24 VDC)		
Control outputs		NPN or PNP open collector Load power supply voltage: 26.4 VDC max. Load current: 50 mA max. (residual voltage: 2 V max.)		
Number of control outputs		1	2	
External input *3 (page 4)		---	Remote control	Bank switching
Protection circuits		Reverse polarity for power supply connection, Output short-circuit, Reversed output polarity protection		
Response time	Super-high-speed mode *4	Operate or reset: 60 μs	Operate or reset: 120 μs	
	High-speed mode	Operate or reset: 300 μs	Operate or reset: 600 μs	
	Standard mode	Operate or reset: 1 ms	Operate or reset: 2 ms	
	High-resolution mode	Operate or reset: 4 ms	Operate or reset: 8 ms	
Sensitivity setting (color registration, allowable range)		Teaching (one-point teaching or teaching with/without workpiece) or manual adjustment		
Functions	Operation mode	ON for match (ON for same color as registered color) or ON for mismatch (ON for different color from registered color)		
	Timer function	Timer type: OFF delay, ON delay, or one-short, Timer time: 1 ms to 5 s (variable)		
	Control outputs	---	Output for each channel, AND output, and OR output	
	Remote control	---	One-point teaching, teaching with/without workpiece, zero reset, and light emission OFF	Bank switching (switching between banks A and B and banks C and D)
	Display switch *5	Seven patterns total: Match + Threshold, Margin + Threshold, Analog bar display, Peak + Bottom, etc.		
	Initialization	Initial reset (factory defaults) or user reset (saved settings)		Initial reset (factory defaults)
	Zero reset	Supported		Not supported
Indicators		Operation indicator (orange)/I mode display indicator (orange)	Operation indicator for each channel (orange)	
Digital display		7-segment displays (Main display: Red, Sub-display: Green)		
Display direction		Switchable between normal and reversed.		
Ambient illumination (Receiver side)		Incandescent lamp: 3,000 lux Sunlight: 10,000 lux		
Ambient temperature range *6		Operating: -25°C to 55°C, Storage: -30°C to 70°C (with no icing or condensation)		
Ambient humidity range		Operating and storage: 35% to 85% (with no condensation)		
Insulation resistance		20 MΩ min. (at 500 VDC)		
Dielectric strength		1,000 VAC at 50/60 Hz for 1 minute		
Vibration resistance		Destruction: 10 to 50 Hz with a 1.5-mm double amplitude for 2 h each in X, Y and Z directions		
Shock resistance		Destruction: 500 m/s ² , for 3 times each in X, Y and Z directions		
Degree of protection		IEC IP50 (with Protective Cover attached)		
Connection method		Pre-wired (standard cable length: 2 m) or reduced-wiring connector (Units connected: 16 max.)	Pre-wired (standard cable length: 2 m)	
Weight (packed state)		Pre-wired model: Approx. 100 g, Amplifier unit connector model: Approx. 55 g		
Materials	Case	Polybutylene terephthalate (PBT)		
	Cover	Polycarbonate (PC)		
Accessories		Instruction manual		

Note: Refer to page 4 for *1 to *6.

*1. Sensing Object: Standard Color Card (230 Colors) from Japan Color Enterprise Co., Ltd.)

Color (11 standard colors)	Munsell color notation
White	N9.5
Red	4R 4.5/12.0
Yellow/red	4YR 6.0/11.5
Yellow	5Y 8.5/11.0
Yellow/green	3GY 6.5/10.0
Green	3G 6.5/9.0
Blue/green	5BG 4.5/10.0
Blue	3PB 5.0/10.0
Blue/purple	9PB 5.0/10.0
Purple	7P 5.0/10.0
Red/purple	6RP 4.5/12.5
(Black)	(N2.0)

*2. When teaching with/without a workpiece, the best sensing method will be automatically selected (RGB ratio (C Mode) or light intensity determination (I Mode)). If color differences are not strong enough and RGB ratios would result in unstable detection, then light intensity determination (I Mode) will be selected. The detection mode can be set to C, I, or Black Mode.

*3. Input Specifications

	Contact input (relay or switch)	Non-contact input (transistor)
NPN	ON: Shorted to 0 V (sourcing current: 1 mA max.). OFF: Open or shorted to Vcc.	ON: 1.5 V max. (sourcing current: 1 mA max.). OFF: Vcc - 1.5 V to Vcc (leakage current: 0.1 mA max.)
PNP	ON: Shorted to Vcc (sinking current: 3 mA max.). OFF: Open or shorted to 0 V.	ON: Vcc - 1.5 V to Vcc (sinking current: 3 mA max.). OFF: 1.5 V max. (leakage current: 0.1 mA max.)

Refer to the Instruction Manual for the external input pulse width. A pulse width of 300 ms or longer is required to switch banks for the E3X-DAC□B-S.

*4. Mutual interference prevention cannot be used in super-high-speed mode, and light intensity determination (I Mode) must be used. The response time will be 150 μs if an AND or OR is set for the control outputs.

*5. With light intensity determination (I Mode and Black Mode), the correlation is not displayed, but rather the light intensity is displayed.

*6. The allowable ambient operating temperature changes according to the number of Units that are linked.

2 Units: -25 to 55°C, 3 to 10 Units: -25 to 50°C, and 11 to 16 Units: -25 to 45°C

Amplifier Unit Connectors

Item	Model	E3X-CN11	E3X-CN12
Rated current		2.5 A	
Rated voltage		50 V	
Contact resistance		20 mΩ max. (20 mVDC max., 100 mA max.) (The figure is for connection to the Fiber Amplifier Unit and the adjacent Connector. It does not include the conductor resistance of the cable.)	
No. of insertions		Destruction: 50 times (The figure for the number of insertions is for connection to the Fiber Amplifier Unit and the adjacent Connector.)	
Materials	Housing	Polybutylene terephthalate (PBT)	
	Contacts	Phosphor bronze/gold-plated nickel	
Weight (packed state)		Approx. 55 g	Approx. 25 g

Operating Procedures (Typical)

Detecting Marks



Because it distinguishes RGB ratios, detection is highly resistant to workpiece movement.



Through-beam heads are capable of detecting color differences in semi-transparent objects.

Detecting Black Marks

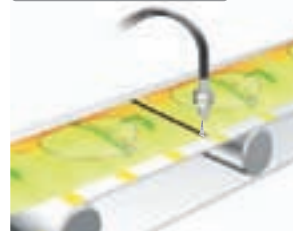

In Black Mode, blank seam tape and other black marks can be detected regardless of film color or patterns

Distinguishing Trays



Four-color determination greatly reduces the work required for line switchovers.

Detecting Wafers



Workpieces that absorb a specific wavelength can be detected with a wide range of wavelengths.

Detecting Products on Conveyors



If you teach the conveyor (i.e., the background), you can detect workpieces even if they have different colors, shapes, or gloss.

Sensing Distance
Reflective Models

(Unit: mm)

Type		Sensing object	White paper				Standard color card (11 colors) (mutual determination)				
			High-resolution mode	Standard mode	High-speed mode	Super-high-speed mode	High-resolution mode	Standard mode	High-speed mode	Super-high-speed mode	
Standard models	General-purpose	E32-DC200	70	54	46	18	14	10	8.5	6	
		E32-D11R/E32-D12R/ E32-D15XR/E32-D11N/ E32-DC200BR(B4R)	42	32	26	11	8.5	6	5	3.5	
		E32-D14LR	11	8.5	7	2.5	2.4	1.7	1.4	1	
		E32-D15YR/E32-D15ZR	10	7.5	6.5	2.5	2.1	1.5	1.3	0.9	
		E32-D211/E32-DC200E/ E32-D22/E32-D25X/ E32-DC200F(F4)	20	16	14	5	4.5	3	2.5	1.5	
		E32-D24	8.8	6.7	5.8	2.1	1.8	1.3	1.1	0.7	
		E32-D25Y/E32-D25Z	5.8	4.5	3.8	1.4	1.2	0.9	0.7	0.5	
	Break-resistant	E32-D11/E32-D15XB	42	32	26	11	8.5	6	5	3.5	
		E32-D21B/E32-D221B	19	15	13	4.5	4.1	3	2.4	1.5	
		E32-D21/E32-D22B	8.8	6.7	5.8	2.1	1.8	1.3	1.1	0.7	
		E32-D25XB	14	10	9	3	3	2.1	1.7	1.1	
	Fluorine coating	E32-D11U	42	32	26	11	8.5	6	5	3.5	
	Special-beam models	Long distance, high power	E32-A09	20 to 38	24 to 36	26 to 32	---	20 to 38	24 to 36	26 to 32	---
			E32-D11L	90	70	60	22	19	13	11	7.5
E32-D21L/E32-D22L			35	26	22	8	7	5	4	2.5	
Coaxial		E32-CC200	60	45	35	16	12	9	7	4	
		E32-CC200R/E32-C11N	35	26	22	9	7.5	5	4.5	3	
		E32-D32L	35	26	22	9	7.5	5	4.5	3	
		E32-C31/E32-D32	17	13	11	4.5	3.7	2.7	2.2	1.5	
		E32-C31N	7.7	6	4.8	2.1	1.6	1.2	0.9	0.7	
Area sensing		E32-D36P1	35	26	22	9	7.5	5	4.5	3	
Environment resistant models	Heat-resistant	E32-D51	55	42	36	14	11	8.5	7	4.5	
		E32-D81R-S/E32-D61-S	20	15	13	5	4	3	2.5	1.5	
		E32-D73-S	13	10	8.5	3.5	2.8	2	1.7	1.2	
	Chemical resistant	E32-D12F	22	17	15	6	4.9	3.5	2.9	2	
		E32-D14F	9	7	6	2	2.1	1.4	1.2	0.6	

Through-beam Models

(Unit: mm)

Type		Sensing object	Opaque object				Translucent object *			
			High-resolution mode	Standard mode	High-speed mode	Super-high-speed mode	High-resolution mode	Standard mode	High-speed mode	Super-high-speed mode
Standard models	General-purpose	E32-TC200	200	160	140	70	45	32	26	22
		E32-T11R/E32-T12R/ E32-T15XR/E32-T11N/ E32-TC200BR(B4R)	150	110	95	50	30	22	18	16
		E32-T14LR/E32-T15YR/ E32-T15ZR	55	44	38	19	12	8.5	7	6.5
		E32-TC200E/E32-T22/ E32-T222/E32-T25X/ E32-TC200F(F4)	80	60	50	46	17	12	10	7
		E32-T24/E32-T25Y/ E32-T25Z	48	36	32	26	10	7	6	4
	Break-resistant	E32-T11/E32-T12B/ E32-T15XB	190	140	120	60	40	28	24	20
		E32-T21/E32-T221B/ E32-T22B	70	55	48	40	15	11	9	6
		E32-T25XB	55	42	36	30	11	8	7	4.5
	Fluorine coating	E32-T11U	190	140	120	60	40	28	24	20
	Special-beam models	Long distance, high power	E32-T17L	4300	3200	2800	1400	900	600	500
E32-TC200 + E39-F1			1100	850	700	360	220	160	140	120
E32-T11R + E39-F1			1000	750	650	340	220	150	130	110
E32-T11N+E39-F1			1000	750	650	320	200	150	120	110
E32-T11 + E39-F1			1000	750	650	320	200	150	120	110
E32-T14			950	700	600	300	200	140	120	100
E32-T11L/E32-T12L			350	250	200	120	75	55	46	40
E32-T11L + E39-F2			220	160	140	75	46	32	28	25
E32-T11R + E39-F2			110	85	70	36	22	16	14	12
E32-T11 + E39-F2			180	140	120	60	38	28	22	20
Fine beam		E32-T12L/E32-T22L	160	120	100	90	34	24	20	14
		E32-T22S	500	400	350	170	110	80	65	55
		E32-T24S	360	280	240	120	75	55	46	40
Area sensing		E32-T16	750	600	500	250	160	110	95	85
		E32-T16PR	240	180	150	80	50	36	30	26
		E32-T16JR	200	160	130	65	44	30	26	22
		E32-T16WR	360	280	240	120	75	55	46	40
Label detection (Slot Sensor)		E32-G14	10				10			

*These sensing distances are recommended to make the most of the detection capabilities of the Sensor.

Type		Sensing object	Opaque object				Translucent object *			
			High-resolution mode	Standard mode	High-speed mode	Super-high-speed mode	High-resolution mode	Standard mode	High-speed mode	Super-high-speed mode
Environment resistant models	Heat-resistant	E32-T51	200	160	140	70	44	32	26	22
		E32-T54	60	48	42	20	13	9.5	8.1	7
		E32-T81R-S	75	60	50	26	16	11	9.5	8.5
		E32-T61-S	120	95	80	42	26	19	16	14
		E32-T61-S + E39-F1	950	700	600	320	200	140	120	100
		E32-T61-S + E39-F2	120	95	80	42	26	19	16	14
	E32-T84S-S	360	280	240	120	75	55	46	40	
	Chemical resistant	E32-T11F	550	420	360	180	110	80	70	60
		E32-T12F	850	650	550	280	180	120	100	95
		E32-T14F	100	80	70	35	22	16	13	12
		E32-T51F	380	300	250	130	80	55	48	44
		E32-T81F-S	190	150	120	65	40	28	24	22
	Vacuum resistant	E32-T51V	55	42	36	18	11	8.5	7	6
		E32-T51V + E39-F1V	280	200	180	90	55	42	35	30
		E32-T54V	36	28	24	12	7.5	5.5	4.5	4
		E32-T54V + E39-F1V	140	100	90	46	28	20	17	15
		E32-T84SV	130	100	85	45	28	20	17	15

*These sensing distances are recommended to make the most of the detection capabilities of the Sensor.

Refer to the → **E32 Series Fiber Sensor Best Selection Guide (Cat. No. E353)**.

Engineering Data (Typical)

Color vs. Detection Capability

E3X-DAC□-S + E32-CC200

	White	Red	Yellow/red	Yellow	Yellow/green	Green	Blue/green	Blue	Blue/purple	Purple	Red/purple	Black*
White		○	○	○	○	○	○	○	○	○	○	○
Red	○		○	○	○	○	○	○	○	○	○	○
Yellow/red	○	○		○	○	○	○	○	○	○	○	○
Yellow	○	○	○		○	○	○	○	○	○	○	○
Yellow/green	○	○	○	○		○	○	○	○	○	○	○
Green	○	○	○	○	○		○	○	○	○	○	○
Blue/green	○	○	○	○	○	○		○	○	○	○	○
Blue	○	○	○	○	○	○	○		○	○	○	○
Blue/purple	○	○	○	○	○	○	○	○		○	○	○
Purple	○	○	○	○	○	○	○	○	○		○	○
Red/purple	○	○	○	○	○	○	○	○	○	○		○
Black*	○	○	○	○	○	○	○	○	○	○	○	

Sensing distance: 9 mm (i.e., the teaching distance)

○: Detection possible, X: Detection not possible.

*. Use 2-point teaching to distinguish between white and black.

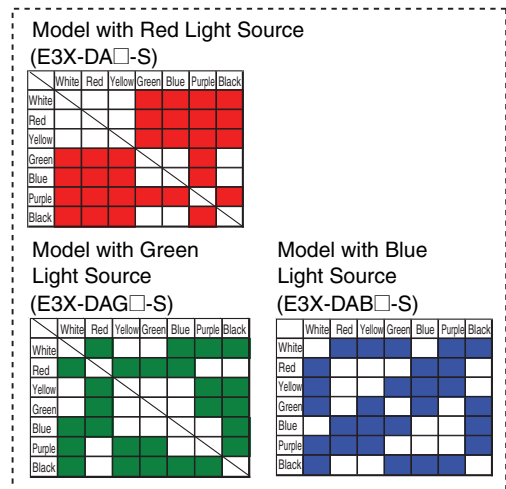

Color Detection Characteristics

E3X-DAC□-S + E32-CC200

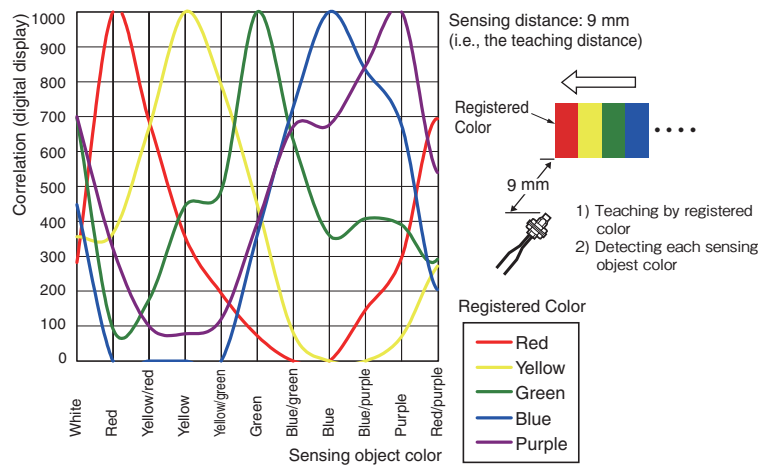

Correlation vs. Distance

E3X-DAC□-S + E32-CC200

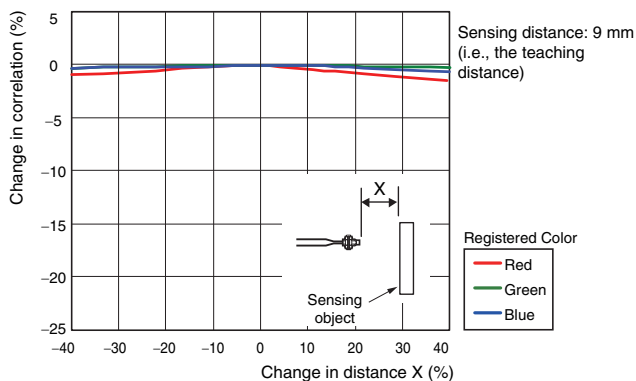

Color Detection Capability vs. Distance

E3X-DA□-S + E32-CC200

E3X-DAB/G□-S + E32-CC200 (Model with single-color light source)

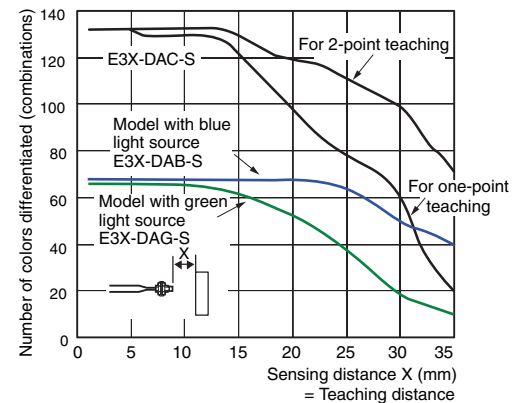

Correlation vs. Angle

E3X-DAC□-S + E32-CC200

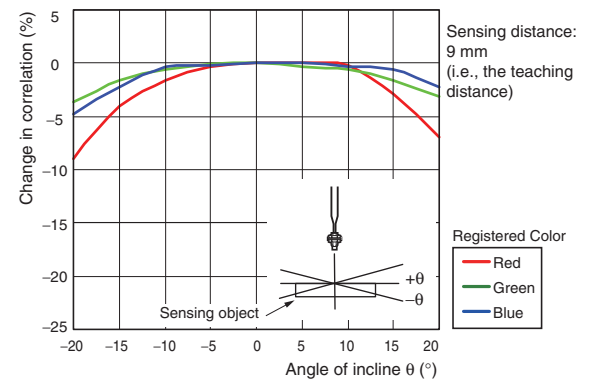

I/O Circuit Diagrams

NPN Output

Model	Operation mode	Timing charts	Operation selector switch	Output circuit
E3X-DAC11-S E3X-DAC6-S	ON for match		LIGHT ON (L-ON)	
	ON for mismatch		DARK ON (D-ON)	
E3X-DAC21-S E3X-DAC21B-S	ON for match		LIGHT ON (L-ON)	
	ON for mismatch		DARK ON (D-ON)	

PNP Output

Model	Operation mode	Timing charts	Operation selector switch	Output circuit
E3X-DAC41-S E3X-DAC8-S	ON for match		LIGHT ON (L-ON)	
	ON for mismatch		DARK ON (D-ON)	
E3X-DAC51-S E3X-DAC51B-S	ON for match		LIGHT ON (L-ON)	
	ON for mismatch		DARK ON (D-ON)	

Note 1. Timing Charts for Timer Function Settings (T: Set Time)

ON delay	OFF delay	One-shot

2. Control Outputs (AND, OR, Sync) and Timing Chart for Timer Settings (T: Set Time)

CH1 ON	CH1 ON	CH1 ON	CH1 ON
CH1 OFF	CH1 OFF	CH1 OFF	CH1 OFF
CH2 ON	CH2 ON	CH2 ON	CH2 ON
CH2 OFF	CH2 OFF	CH2 OFF	CH2 OFF
OUT (AND) ON	OUT (AND) ON	OUT (AND) ON	OUT (AND) ON
OUT (AND) OFF	OUT (AND) OFF	OUT (AND) OFF	OUT (AND) OFF
OUT (OR) ON	OUT (OR) ON	OUT (OR) ON	OUT (OR) ON
OUT (OR) OFF	OUT (OR) OFF	OUT (OR) OFF	OUT (OR) OFF
One-shot (AND) ON	One-shot (AND) ON	One-shot (AND) ON	One-shot (AND) ON
One-shot (AND) OFF	One-shot (AND) OFF	One-shot (AND) OFF	One-shot (AND) OFF

Nomenclature

Fiber Amplifier Units

Standard Models

E3X-DAC□-S (□: 11/41/6/8)

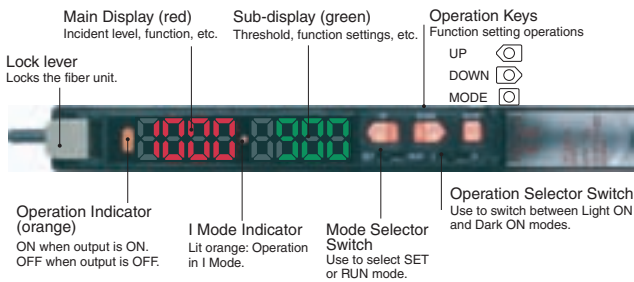

Advanced models with simultaneous 2-color determination

E3X-DAC□-S (□: 21/51)

Advanced models with 4-color determination

E3X-DAC□B-S (□: 21/51)

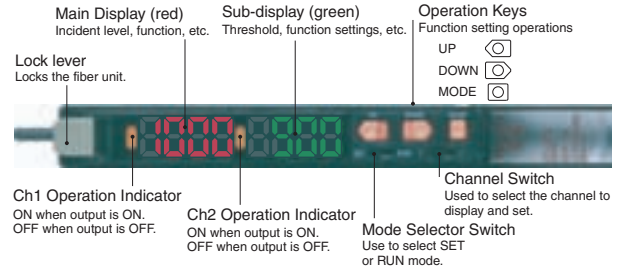

Safety Precautions

Refer to *Warranty and Limitations of Liability*.

WARNING

This product is not designed or rated for ensuring safety of persons either directly or indirectly.

Do not use it for such purposes.



CAUTION

Do not use the product with voltage in excess of the rated voltage. Excess voltage may result in malfunction or fire.



Never use the product with an AC power supply.

Otherwise, explosion may result.



High-temperature environments may result in burn injury.



Precautions for Safe Use

The following precautions must be observed to ensure safe operation of the Sensor.

1. Do not use the Sensor in an environment where explosive or flammable gas is present.
2. Do not use the Sensor in a location subject to splattering of water, oils, or chemicals.
3. Do not attempt to disassemble, repair, or modify the Sensor.
4. Do not apply voltages or currents that exceed the rated range to the Sensor.
5. Do not use the Sensor in an ambient atmosphere or environment that exceeds the ratings.
6. Wire the power supply correctly, including the polarity.
7. Connect the load correctly.
8. Do not short-circuit the load at both ends.
9. Do not use the Sensor if the case is damaged.
10. Dispose of the Sensor as industrial waste.
11. Do not use the Sensor in locations subject to direct sunlight.
12. Burn injury may occur. The Sensor surface temperature rises depending on application conditions, such as the ambient temperature and the power supply voltage. Use caution when operating or performing maintenance on the Sensor.

Precautions for Correct Use

Do not use the product in atmospheres or environments that exceed product ratings.

Fiber Amplifier Unit

● Designing

Operation after Turning Power ON

The Sensor is ready to detect within 200 ms after the power supply is turned ON. If the Sensor and load are connected to separate power supplies, be sure to turn ON the Sensor first. Time may be required for the degree of match to stabilize after the power supply is turned ON.

Operation When Turning Power OFF

Output pulses may occur when the power is turned OFF. Turn OFF the power supply to the load and the load line before turning OFF the power supply to the Sensor.

● Mounting

Connecting and Disconnecting Connectors

Mounting Connectors

1. Insert the Master or Slave Connector into the Amplifier Unit until it clicks into place.

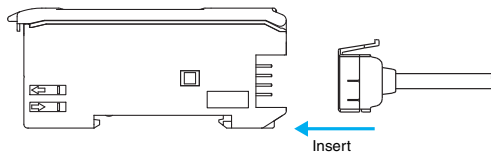

2. Attach the protector seals (provided as accessories) to the sides of master and slave connectors that are not connected.

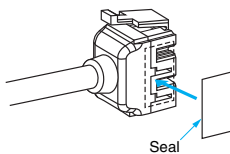

Note: Attach the seals to the sides with grooves.

Removing Connectors

1. Slide the slave Amplifier Unit(s) for which the Connector is to be removed away from the rest of the group.
2. After the Amplifier Unit(s) has been separated, press down on the lever on the Connector and remove it. (Do not attempt to remove Connectors without separating them from other Amplifier Units first.)

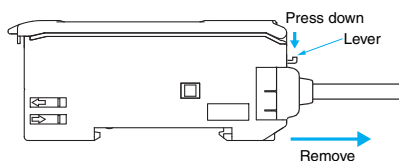

Adding and Removing Fiber Amplifier Units

Adding Fiber Amplifier Units

1. Mount the Amplifier Units one at a time onto the DIN track.

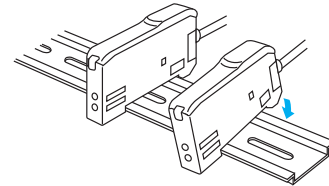

2. Slide the Amplifier Units together, line up the clips, and press the Amplifier Units together until they click into place.

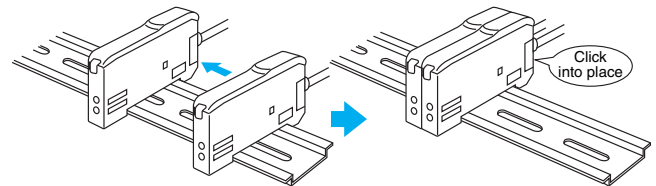

Removing Fiber Amplifier Units

Slide Amplifier Units away from each other, and remove from the DIN track one at a time. (Do not attempt to remove Amplifier Units from the DIN track without separating them first.)

Note 1. The specifications for ambient temperature will vary according to the number of Amplifier Unit used together. For details, refer to *Ratings and Specifications* on → page 3.
 2. Always turn OFF the power supply before joining or separating Amplifier Units.

Mounting the End Plate (PFP-M)

An End Plate should be used if there is a possibility of the Amplifier Unit moving, e.g., due to vibration.

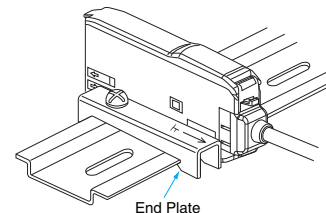

Fiber Unit Connection

The E3X Amplifier Unit has a lock button for easy connection of the Fiber Unit. Connect or disconnect the fiber units using the following procedures:

1. Connection

Open the protective cover and raise the lock lever to release the lock. Next, insert the fiber units according to the fiber unit insertion marks on the side of the Amplifier Unit, and lower the lock lever.

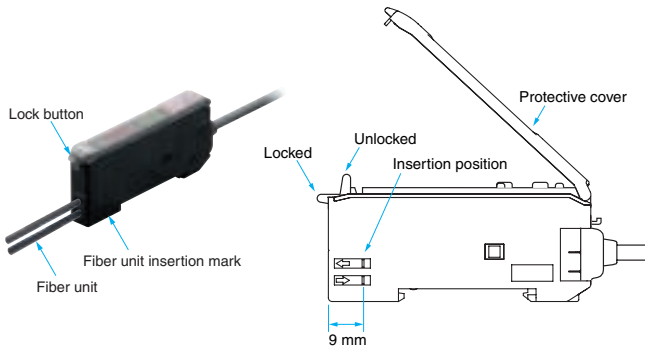

Note: Do not pull on, compress, or otherwise exert excessive force on the fiber units after connecting them to the Amplifier Unit.

Note: If one of the fibers from the Fiber Unit is labeled as the Emitter fiber, such as with a Coaxial Sensor, insert that fiber into the Emitter section. Refer to *Dimensions for the Fiber Unit* to see if there is an Emitter fiber label.

2. Disconnecting Fiber Units

Remove the protective cover and raise the lock lever to pull out the fiber units.

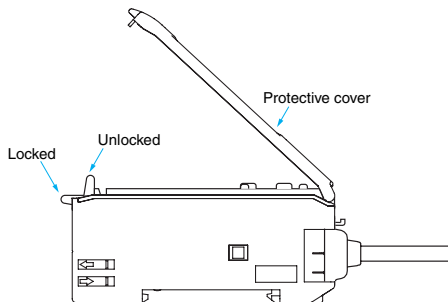

Note 1. To maintain the fiber unit properties, confirm that the lock is released before removing the fiber units.
2. Be sure to lock or unlock the lock button within an ambient temperature range between -10°C and 40°C .

● Adjusting

Mutual Interference Protection Function

Light from other sensors can cause the value on the digital display to become somewhat unstable. If this occurs, reduce the threshold to create a greater margin and enable more stable detection.

Output Short-circuits Protection

OVER/CUR will flash on the display if the output short-circuit protection function operates due to a load short-circuit in a control output. If this occurs, check the load connections.

EEPROM Writing Error

If the data is not written to the EEPROM correctly due to a power failure or static-electric noise, initialize the settings with the keys on the Amplifier Unit. ERR/EEP will flash on the display when a writing error has occurred.

Optical Communications

Several Amplifier Units can be slid together and used in groups. Do not, however, slide the Amplifier Units or attempt to remove any of the Amplifier Units during operation.

● Others

Protective Cover

Always keep the protective cover in place when using the Amplifier Unit.

Fiber Unit

● Design Precautions

Applicable Fiber Units

Refer to the sensing distance tables on pages 5 to 7 for the Fiber Units that can be used and the sensing distances. Retro-reflective, Convergent-reflective, Ultra-compact, and Application-specific Fiber Units, which are not listed, cannot be used.

● Installation Precautions

Glossy Sensing Objects

If the sensing object is glossy, detection may not be stable. If the Sensor is inclined by 5° to 20° when using a glossy sensing object, as shown below, detection capabilities can be increased and stable detection achieved.

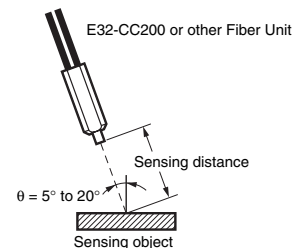

Dimensions

Fiber Amplifier Units

Pre-wired Amplifier Units

E3X-DAC11-S
E3X-DAC41-S
E3X-DAC21-S
E3X-DAC51-S
E3X-DAC21B-S
E3X-DAC51B-S



Area of digital indication

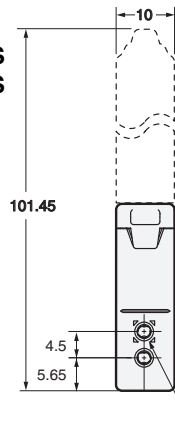
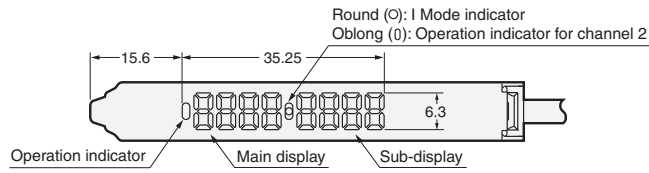

DIN track mounting

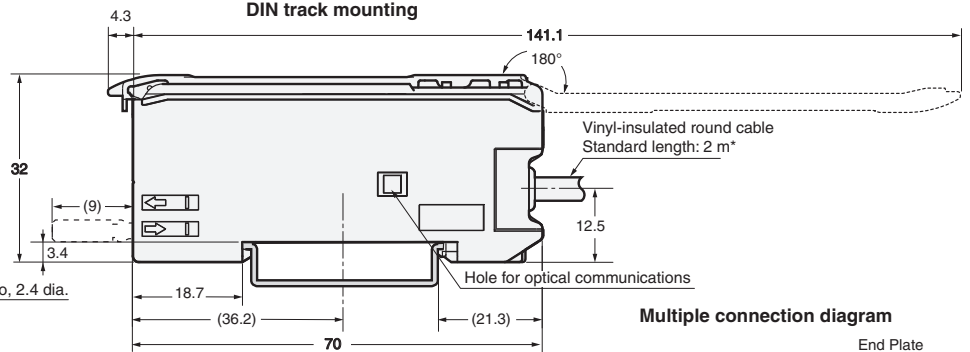

Multiple connection diagram

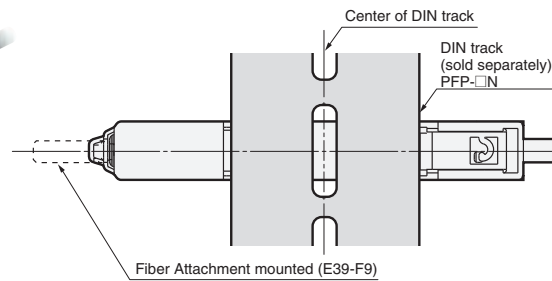
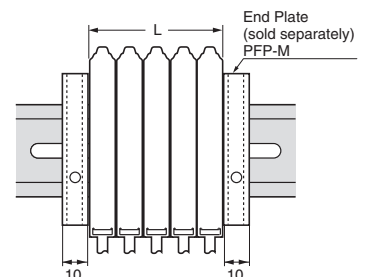

* Cable Specifications

E3X-DAC11-S -DAC41-S	4-dia., 3-conductor (Conductor cross section: 0.2 mm ² , insulator diameter: 1.1 mm)
E3X-DAC21-S -DAC51-S -DAC21B-S -DAC51B-S	4-dia., 5-conductor (Conductor cross section: 0.2 mm ² , insulator diameter, 1.1 mm)

The number of expansion	L (mm)
1	10
2	20
3	30
4	40
5	50
6	60
7	70
8	80
9	90
10	100

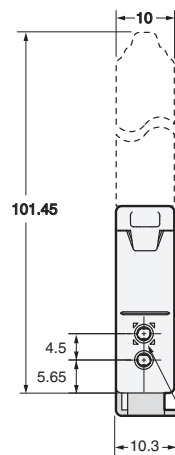

With Mounting Bracket Attached

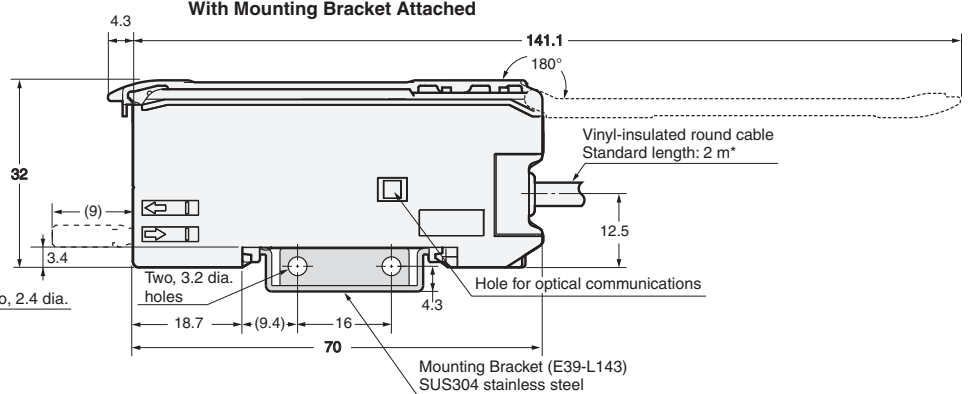

Mounting Holes

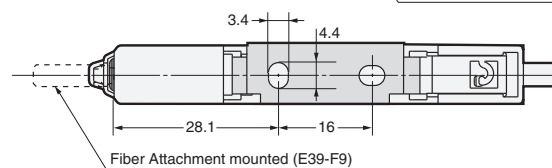
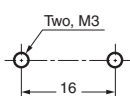

Note: When using E39-L143 Mounting Brackets, there will be small gaps between the Fiber Amplifier Units if they are mounted side by side.

Amplifier Units with Connectors

E3X-DAC6-S
E3X-DAC8-S

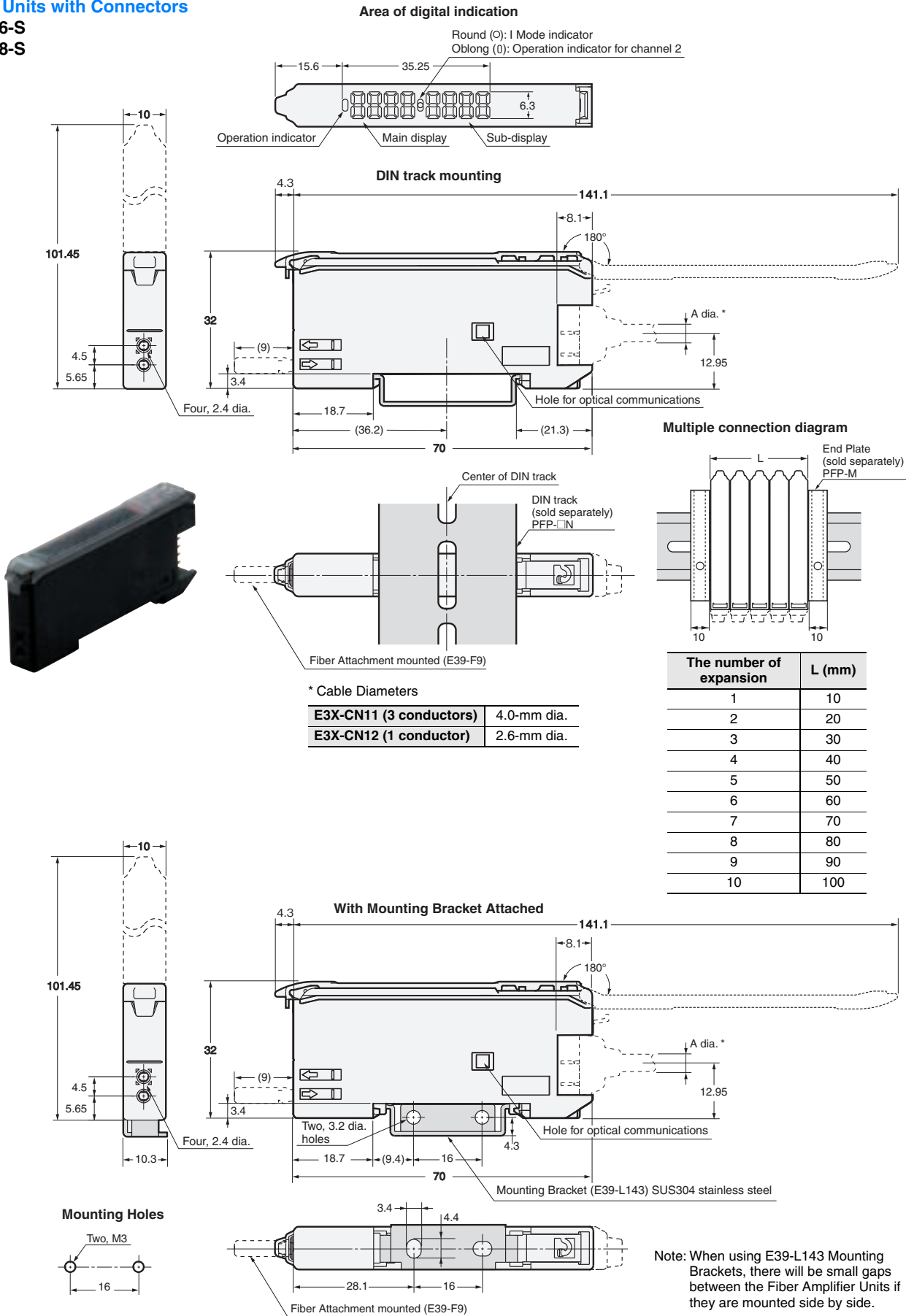

Amplifier Unit Connectors

Master Connectors

E3X-CN11

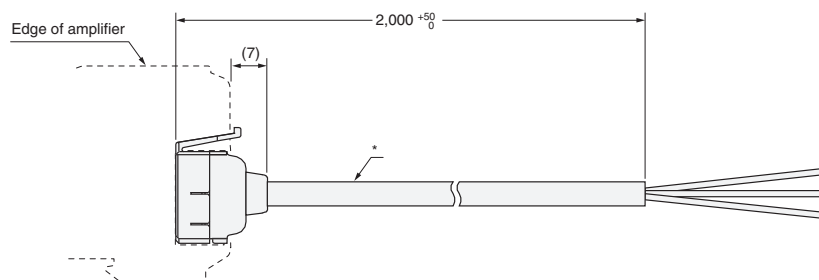

* E3X-CN11: **4 dia. cable / 3 conductors** / Standard length: 2 m (Conductor cross section: 0.2 mm² (AWG24), Insulator diameter: 1.1 mm)

Slave Connectors

E3X-CN12

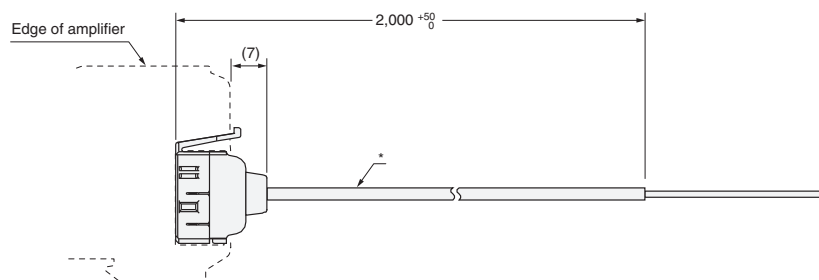

* E3X-CN12: **2.6 dia. cable / 1 conductor** / Standard length: 2 m (Conductor cross section: 0.2 mm² (AWG24), Insulator diameter: 1.1 mm)

Terms and Conditions Agreement

Read and understand this catalog.

Please read and understand this catalog before purchasing the products. Please consult your OMRON representative if you have any questions or comments.

Warranties.

(a) Exclusive Warranty. Omron's exclusive warranty is that the Products will be free from defects in materials and workmanship for a period of twelve months from the date of sale by Omron (or such other period expressed in writing by Omron). Omron disclaims all other warranties, express or implied.

(b) Limitations. OMRON MAKES NO WARRANTY OR REPRESENTATION, EXPRESS OR IMPLIED, ABOUT NON-INFRINGEMENT, MERCHANTABILITY OR FITNESS FOR A PARTICULAR PURPOSE OF THE PRODUCTS. BUYER ACKNOWLEDGES THAT IT ALONE HAS DETERMINED THAT THE PRODUCTS WILL SUITABLY MEET THE REQUIREMENTS OF THEIR INTENDED USE.

Omron further disclaims all warranties and responsibility of any type for claims or expenses based on infringement by the Products or otherwise of any intellectual property right. (c) Buyer Remedy. Omron's sole obligation hereunder shall be, at Omron's election, to (i) replace (in the form originally shipped with Buyer responsible for labor charges for removal or replacement thereof) the non-complying Product, (ii) repair the non-complying Product, or (iii) repay or credit Buyer an amount equal to the purchase price of the non-complying Product; provided that in no event shall Omron be responsible for warranty, repair, indemnity or any other claims or expenses regarding the Products unless Omron's analysis confirms that the Products were properly handled, stored, installed and maintained and not subject to contamination, abuse, misuse or inappropriate modification. Return of any Products by Buyer must be approved in writing by Omron before shipment. Omron Companies shall not be liable for the suitability or unsuitability or the results from the use of Products in combination with any electrical or electronic components, circuits, system assemblies or any other materials or substances or environments. Any advice, recommendations or information given orally or in writing, are not to be construed as an amendment or addition to the above warranty.

See <http://www.omron.com/global/> or contact your Omron representative for published information.

Limitation on Liability; Etc.

OMRON COMPANIES SHALL NOT BE LIABLE FOR SPECIAL, INDIRECT, INCIDENTAL, OR CONSEQUENTIAL DAMAGES, LOSS OF PROFITS OR PRODUCTION OR COMMERCIAL LOSS IN ANY WAY CONNECTED WITH THE PRODUCTS, WHETHER SUCH CLAIM IS BASED IN CONTRACT, WARRANTY, NEGLIGENCE OR STRICT LIABILITY.

Further, in no event shall liability of Omron Companies exceed the individual price of the Product on which liability is asserted.

Suitability of Use.

Omron Companies shall not be responsible for conformity with any standards, codes or regulations which apply to the combination of the Product in the Buyer's application or use of the Product. At Buyer's request, Omron will provide applicable third party certification documents identifying ratings and limitations of use which apply to the Product. This information by itself is not sufficient for a complete determination of the suitability of the Product in combination with the end product, machine, system, or other application or use. Buyer shall be solely responsible for determining appropriateness of the particular Product with respect to Buyer's application, product or system. Buyer shall take application responsibility in all cases.

NEVER USE THE PRODUCT FOR AN APPLICATION INVOLVING SERIOUS RISK TO LIFE OR PROPERTY OR IN LARGE QUANTITIES WITHOUT ENSURING THAT THE SYSTEM AS A WHOLE HAS BEEN DESIGNED TO ADDRESS THE RISKS, AND THAT THE OMRON PRODUCT(S) IS PROPERLY RATED AND INSTALLED FOR THE INTENDED USE WITHIN THE OVERALL EQUIPMENT OR SYSTEM.

Programmable Products.

Omron Companies shall not be responsible for the user's programming of a programmable Product, or any consequence thereof.

Performance Data.

Data presented in Omron Company websites, catalogs and other materials is provided as a guide for the user in determining suitability and does not constitute a warranty. It may represent the result of Omron's test conditions, and the user must correlate it to actual application requirements. Actual performance is subject to the Omron's Warranty and Limitations of Liability.

Change in Specifications.

Product specifications and accessories may be changed at any time based on improvements and other reasons. It is our practice to change part numbers when published ratings or features are changed, or when significant construction changes are made. However, some specifications of the Product may be changed without any notice. When in doubt, special part numbers may be assigned to fix or establish key specifications for your application. Please consult with your Omron's representative at any time to confirm actual specifications of purchased Product.

Errors and Omissions.

Information presented by Omron Companies has been checked and is believed to be accurate; however, no responsibility is assumed for clerical, typographical or proofreading errors or omissions.

2014.2

In the interest of product improvement, specifications are subject to change without notice.

OMRON Corporation
Industrial Automation Company

<http://www.ia.omron.com/>

(c)Copyright OMRON Corporation 2014 All Right Reserved.

Terms and Conditions Agreement

Read and understand this catalog.

Please read and understand this catalog before purchasing the products. Please consult your OMRON representative if you have any questions or comments.

Warranties.

(a) Exclusive Warranty. Omron's exclusive warranty is that the Products will be free from defects in materials and workmanship for a period of twelve months from the date of sale by Omron (or such other period expressed in writing by Omron). Omron disclaims all other warranties, express or implied.

(b) Limitations. OMRON MAKES NO WARRANTY OR REPRESENTATION, EXPRESS OR IMPLIED, ABOUT NON-INFRINGEMENT, MERCHANTABILITY OR FITNESS FOR A PARTICULAR PURPOSE OF THE PRODUCTS. BUYER ACKNOWLEDGES THAT IT ALONE HAS DETERMINED THAT THE PRODUCTS WILL SUITABLY MEET THE REQUIREMENTS OF THEIR INTENDED USE.

Omron further disclaims all warranties and responsibility of any type for claims or expenses based on infringement by the Products or otherwise of any intellectual property right. (c) Buyer Remedy. Omron's sole obligation hereunder shall be, at Omron's election, to (i) replace (in the form originally shipped with Buyer responsible for labor charges for removal or replacement thereof) the non-complying Product, (ii) repair the non-complying Product, or (iii) repay or credit Buyer an amount equal to the purchase price of the non-complying Product; provided that in no event shall Omron be responsible for warranty, repair, indemnity or any other claims or expenses regarding the Products unless Omron's analysis confirms that the Products were properly handled, stored, installed and maintained and not subject to contamination, abuse, misuse or inappropriate modification. Return of any Products by Buyer must be approved in writing by Omron before shipment. Omron Companies shall not be liable for the suitability or unsuitability or the results from the use of Products in combination with any electrical or electronic components, circuits, system assemblies or any other materials or substances or environments. Any advice, recommendations or information given orally or in writing, are not to be construed as an amendment or addition to the above warranty.

See <http://www.omron.com/global/> or contact your Omron representative for published information.

Limitation on Liability; Etc.

OMRON COMPANIES SHALL NOT BE LIABLE FOR SPECIAL, INDIRECT, INCIDENTAL, OR CONSEQUENTIAL DAMAGES, LOSS OF PROFITS OR PRODUCTION OR COMMERCIAL LOSS IN ANY WAY CONNECTED WITH THE PRODUCTS, WHETHER SUCH CLAIM IS BASED IN CONTRACT, WARRANTY, NEGLIGENCE OR STRICT LIABILITY.

Further, in no event shall liability of Omron Companies exceed the individual price of the Product on which liability is asserted.

Suitability of Use.

Omron Companies shall not be responsible for conformity with any standards, codes or regulations which apply to the combination of the Product in the Buyer's application or use of the Product. At Buyer's request, Omron will provide applicable third party certification documents identifying ratings and limitations of use which apply to the Product. This information by itself is not sufficient for a complete determination of the suitability of the Product in combination with the end product, machine, system, or other application or use. Buyer shall be solely responsible for determining appropriateness of the particular Product with respect to Buyer's application, product or system. Buyer shall take application responsibility in all cases.

NEVER USE THE PRODUCT FOR AN APPLICATION INVOLVING SERIOUS RISK TO LIFE OR PROPERTY OR IN LARGE QUANTITIES WITHOUT ENSURING THAT THE SYSTEM AS A WHOLE HAS BEEN DESIGNED TO ADDRESS THE RISKS, AND THAT THE OMRON PRODUCT(S) IS PROPERLY RATED AND INSTALLED FOR THE INTENDED USE WITHIN THE OVERALL EQUIPMENT OR SYSTEM.

Programmable Products.

Omron Companies shall not be responsible for the user's programming of a programmable Product, or any consequence thereof.

Performance Data.

Data presented in Omron Company websites, catalogs and other materials is provided as a guide for the user in determining suitability and does not constitute a warranty. It may represent the result of Omron's test conditions, and the user must correlate it to actual application requirements. Actual performance is subject to the Omron's Warranty and Limitations of Liability.

Change in Specifications.

Product specifications and accessories may be changed at any time based on improvements and other reasons. It is our practice to change part numbers when published ratings or features are changed, or when significant construction changes are made. However, some specifications of the Product may be changed without any notice. When in doubt, special part numbers may be assigned to fix or establish key specifications for your application. Please consult with your Omron's representative at any time to confirm actual specifications of purchased Product.

Errors and Omissions.

Information presented by Omron Companies has been checked and is believed to be accurate; however, no responsibility is assumed for clerical, typographical or proofreading errors or omissions.

2014.2

In the interest of product improvement, specifications are subject to change without notice.

OMRON Corporation
Industrial Automation Company

<http://www.ia.omron.com/>

(c)Copyright OMRON Corporation 2014 All Right Reserved.