

Air Flow Sensor D6FZ

CSM_D6FZ_DS_E_3_1

Visualization of Compressed Air Flow Rates, Pressures, and Leakage Rates on Production Lines and Equipment

- Ideal for measuring compressed air in manufacturing lines and equipment.
- Can be mounted behind curved pipes.
- The D6FZ-FGS1000 simultaneously measures the flow rate, leakage rate, and pressure.
- The D6FZ-FGT200/500 provides easy-to-read 11-segment 8-digit displays.
- Data can be easily logged at an air flow station.
- Many types of outputs (RS-485, analog, and pulse) to quickly enable visualization on existing systems.



CE

For the most recent information on models that have been certified for safety standards, refer to your OMRON website.

Features

Visualize Air Flows, Pressures, and Leakage to Save Energy on Production Sites.

Consequently

Visualization is required on both the supply side and consumption side. This leads to lower power consumption while maintaining quality.

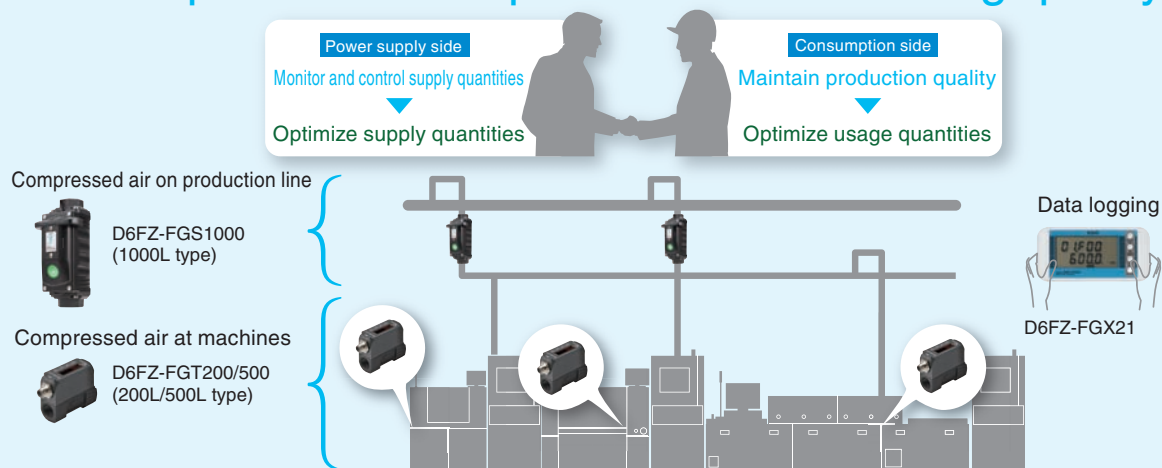

Identify the waste that had previously been invisible to reduce the energy consumed for compressed air.



The Best Product to Measure Compressed Air on Production Lines

D6FZ-FGS1000

- 1
Leakage
- 2
Usage
- 3
Pressure

Pipe size: Rc1 (25A)
(A bushing can be used to convert down to 15A.)

Multi-sensing

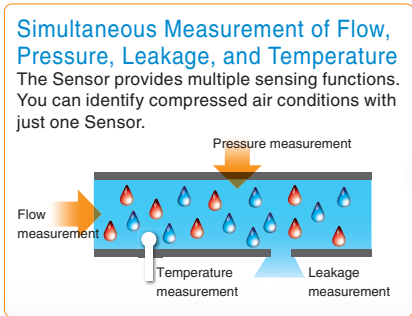

High Accuracy

Highly Accurate Flow Measurements

High measuring accuracy of $\pm 2\%$ R.S. (at 50 L/min or less) is achieved.

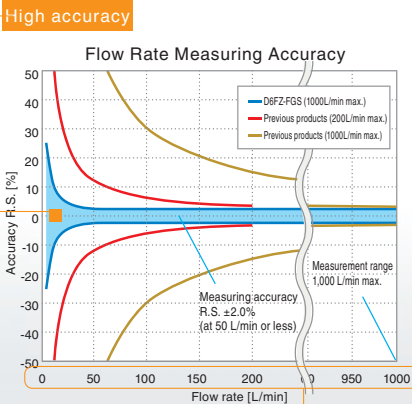

Simple Setup

Mountable to Curved Pipes or Couplers
The built-in silencer eliminates ultrasonic noise and turbulence. It eliminates the need for straight pipes to make installation work easy.

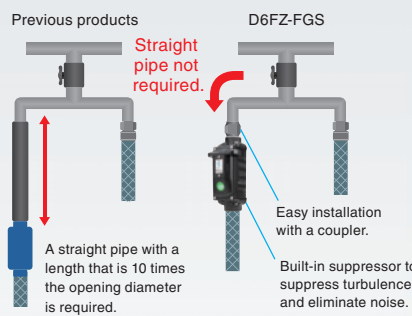

Flow Measurements over a Wide Range

Wide range
A wide measurement range of 1 to 1,000 L/min is achieved.

Resists Oils and Mist

Ultrasonic sensor
A built-in ultrasonic sensor is used for flow measurements. With high resistance to rusty pipes and oil flooded compressors, you can install the Sensor almost anywhere.

- Main Features**
- Two analog outputs
 - Threshold values (peak, bottom, and leak)
 - Two pulse outputs
 - Alarm hold
 - RS-485 communications
 - Operation indicator
 - IP64

Feature Comparison

Flow measurement	Leakage measurement	Pressure measurement	Temperature measurement
Curved pipe mounting	Resistant to oils and mist	Station connection	Multi-sensor connection

Ideal for Compressed Air Measurements at Machines

- 1
Leakage
- 2
Usage
- 3
Pressure

D6FZ-FGT200/500



200L type Pipe size: 8A (Rc1/4) 500L type Pipe size: 15A (Rc1/2)

Easy to Read

11-segment 8-digit LCD First in the industry!*

The characters are easy to read, and the total flow rate can be checked in a glance.

Clear total flow rate

Averaging count setting

Display Reversal

You can reverse the display direction to match the installation direction. Always use one of the specified installation directions.

Press and hold to reverse.

Note: According to OMRON investigation in June 2013.

High Accuracy

Highly Accurate Flow Measurements

An OMRON MEMS chip is used to achieve the highest accuracy in the industry* of $\pm 2\%$ F.S. (at 50 L/min or less).

With Flow

Without Flow

Note: OMRON survey (as of June 2013)

Leakage Measurement

A high measurement accuracy of $\pm 0.5\%$ F.S. is achieved at a low flow rate of less than 50 L/min. This allows you to identify the air flow that is discarded as leakage when machines are not operating to save money.

Leakage on non-working days (Saturday and Sunday) was 36 m³

Specifications are the same as the 1000L type.

Other Features

Flow Straightener with Honeycomb Structure

A honeycomb structure effectively straightens the flow to keep pressure loss low.

Honeycomb structure

Zero Reset

You can use the zero reset to identify seasonal or day/night variations in the flow rates.

Press and hold.

- Main Features**
- One analog output
 - Threshold values (peak, bottom, and leak)
 - Two pulse outputs
 - Peak/Bottom hold
 - RS-485 communications
 - Auto-tuning
 - IP65
 - Key lock
 - Display

Feature Comparison

Flow measurement	Leakage measurement	Pressure measurement	Temperature measurement
Curved pipe mounting	Resistant to oils and mist	Station connection	Multi-sensor connection

The PC Software Easily Analyzes Logged Data

You can collect onsite data at an Air Flow Station data and use the Multi Data Viewer Light software to analyze the data in your office to identify other locations for improvement on the production site.

On the Production Site:

Data monitoring and storing by Air Flow Station

The Air Flow Station enables easy data logging.



Save the data to an SD memory card. Start data logging with a single press of a button.

Free The PC Software

Multi Data Viewer Light

This software displays data for specific time periods, such as by the minute, hour, or day. The total flow rate is displayed as a bar graph and the momentary flow rate and pressure are displayed with dotted lines, so you can see the overall situation at a glance.

In the Office:

Data storing and analyzing on a computer

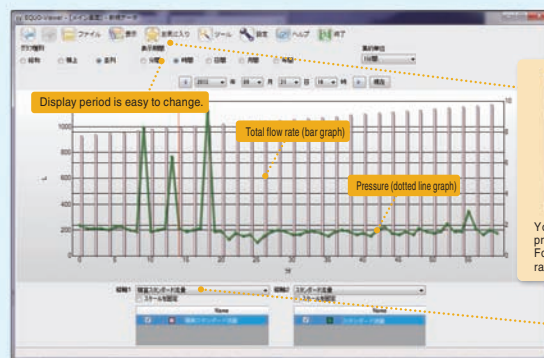

You can use comparative displays with previously logged data. For example, side-by-side comparison of flow rates by the day for different months is possible.

Download the PC Software Station Utility from the following OMRON website (<http://www.fa.omron.co.jp/station-u-e>).

You can save energy in a variety of applications.

Stop Ionizer Idling

D6FZ-FGT

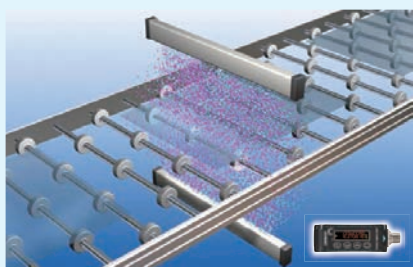

By stopping the supply of compressed air with a solenoid valve when there is no workpiece, compressed air usage is reduced. At the same time, the Flow Sensor monitors the quantity of supplied compressed air to ensure that it is within the specified range. Therefore, the Sensor helps maintain and improve quality.

Flow Management for Molding Machines

D6FZ-FGT

D6FZ-FGS



By giving priority to the monitoring of molding machines and other machines that use large quantities of compressed air, energy is efficiently saved.

Leakage Management for Machines

D6FZ-FGT

D6FZ-FGS

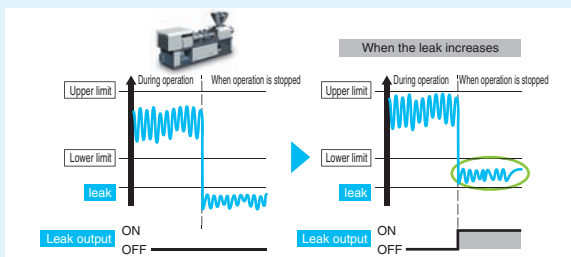

Set the leak threshold value to identify when repairs for leaks are required.

Flow and Pressure Management for Production Lines





D6FZ-FGS







Monitor consumption and pressure fluctuations for each production line to identify bottleneck lines or machines to implement onsite improvements and save energy.

Specifications

Units

Appearance	Product name	Model
	200L-type Air Flow Sensor	D6FZ-FGT200
	500L-type Air Flow Sensor	D6FZ-FGT500
	1000L-type Air Flow Sensor (cable length: 0.2 m)	D6FZ-FGS1000
	Air Flow Station (cable length: 1.5 m, including T-branch Connector cable)	D6FZ-FGX21
	1000L-type Air Flow Sensor Set <ul style="list-style-type: none"> • 1000L-type Air Flow Sensor • Air Flow Station • T-branch Connector • Cable with Connector on One End (3 m) 	D6FZ-FGS1000-S

Options (Sold Separately)

Appearance	Product name	Model		
	T-branch Connector	D6FZ-FC02		
	(D6FZ-FGT Air Flow Sensor only) Mounting Bracket <ul style="list-style-type: none"> • Mounting Bracket: 1 • Phillips screws (M3): 4 	D6FZ-FC03		
	(D6FZ-FGX21 Air Flow Station only) Mounting magnets * <ul style="list-style-type: none"> • Mounting magnets: 2 • Phillips screws (M3): 2 	ZN9-EM01-S		
	Cable with Connector on One End	Cable length: 3 m	M12 connector (8-pin)	D6FZ-JD3A
		Cable length: 10 m		D6FZ-JD10A
		Cable length: 20 m		D6FZ-JD20A
	Cable with Connectors on Both Ends	Cable length: 3 m	M12 connector (8-pin)	D6FZ-JD3B
		Cable length: 5 m		D6FZ-JD5B
		Cable length: 10 m		D6FZ-JD10B
		Cable length: 20 m		D6FZ-JD20B

* When magnets are used, the maximum vibration resistance is 55 Hz.

Ratings

Air Flow Sensor

Item	Model	D6FZ-FGT200	D6FZ-FGT500
Applicable fluid		Air or nitrogen (N ₂)* ¹	
Maximum working pressure		0.75 MPa (withstand pressure: 1.5 MPa)	
Measurement range * ²		0 to 200 L/min	0 to 500 L/min
Measurement range for specified accuracy * ²		2 to 200 L/min	5 to 500 L/min
Display resolution * ²		1 L/min	
Accuracy * ²		±2.0% F.S. at 50 L/min or higher	
		±0.5% F.S. at less than 50 L/min	
Temperature characteristic		±3% F.S.	
Repeat accuracy		±1% F.S.	
Operating temperature		Operation: -10 to 60°C, Storage: -20 to 70°C (with no condensation or icing)	
Operating humidity		Operation: 25% to 90% RH, Storage: 0% to 90% RH (with no condensation or icing)	
Shock resistance (destruction)		150 m/s ² 3 times each in six directions (up/down, left/right, forward/backward)	
Pressure loss		2 kPa max.	4 kPa max.
Power supply voltage		12 to 24 VDC ±10% ripple (p-p): 10% max.	
Current consumption		120 mA max.	
Functions		Momentary flow, total flow, display reversal, zero point adjustment, peak and bottom hold, key lock, eco mode, scaling (analog output), judgement hysteresis, and teaching	
Indications		11-segment digital display (red); RUN, FUN, and THR (yellow); Out1 and Out2 (yellow); key lock (yellow); flow unit (green); and flow unit on reversed display (yellow)	
Outputs	Output interfaces	Analog	Current output: 4 to 20 mA (1 output), Maximum load resistance: 300 Ω
		ON/OFF	Open-collector output (2 outputs): 26.4 VDC 50 mA max. ON residual voltage: 2 V max. (Outputs can be selected from judgement output, pulse output, and Sensor error output.)
		RS-485	2-wire half-duplex communications with start-stop synchronization Baud rate: 9.6, 19.2, 38.4, or 115.2 kbps, Data bit length: 7 or 8 bits, Stop bit length: 1 or 2 bits, Parity: none, even, or odd, Terminating resistance (120 Ω): ON/OFF, Communications protocol: Conforms to CompoWay/F.
	Output values	Momentary flow, total flow, judgement output * ³ , and Sensor error output	
Degree of protection		IP65	
Installation Direction and Straight Pipe Section		A straight pipe section must be provided during installation and piping if the Sensor is installed horizontally and the display is on the top. * ⁴	
Connection pipe diameter		Rc1/4 (8A)	Rc1/2 (15A)
Materials		Main unit: PBT, Flow channel: Zinc	
Dimensions		30 × 77 × 63.7 mm (W×D×H)	
Weight (in package)		Approx. 400 g (500 g)	
Accessories		Instruction Sheet	

*1. Clean dry gas (Must not contain large particles, e.g. dust, oils, or mist.)

*2. The flow rates are converted for the following conditions. Standard flow rate (std): 1 atmospheric pressure (101.3 kPa) at 20°C (default setting)
Normal flow rate (nor): 1 atmospheric pressure (101.3 kPa) at 0°C

*3. To prevent chattering, a judgement output is made when the judgement continues for one minute or longer.

*4. The accuracy will depend on the length of the straight pipe section. Refer to *Flow rate accuracy characteristics* for a length of straight pipe on page 10 for details.

Item	Model	D6FZ-FGS1000	
Applicable fluid		Air or nitrogen (N ₂)	
Working pressure		0.99MPa max.	
Measurements	Flow ^{*1}	Detection range	1 to 1,000 L/min (std)
		Resolution	0.1 L/min
		Accuracy	±2.0% of reading at 50 L/min (std) or higher ^{*2} ±0.1% F.S. at less than 50 L/min ^{*2}
	Pressure	Detection range	0 to 0.99 MPa
		Accuracy	2% F.S.
	Temperature	Detection range	-10 to 60°C
Accuracy		±1.5% (absolute temperature)	
Resistance to environment	Operating temperature		-10 to 60°C (with no condensation or icing)
	Operating humidity		35% to 85% RH (with no condensation or icing)
	Vibration resistance (destruction)		10 to 55 Hz with a 0.7-mm double amplitude or acceleration of 50 m/s ² for 80 min each in X, Y, and Z directions
	Shock resistance (destruction)		150 m/s ² 3 times each in six directions (up/down, left/right, forward/backward)
Pressure loss		Direct piping: 10 kPa max. (0.5 MPa, at maximum flow) Using Coupler (TL model from Nagahori Industry Co., Ltd.): 10 kPa max. (0.5 MPa, at maximum flow)	
Power supply voltage		For one Sensor: 16 to 24 VDC ±10%, ripple (p-p): 10% max., For multiple Sensors: 24 VDC ±10%, ripple (p-p): 10% max. ^{*3}	
Power consumption		2 W max.	
Measurement cycle		Approx. 62.5 ms	
Display	Display method		Status display with 2-color LED (lit or flashing)
	Displayed contents		Presence of power, air flow, and error alarm
Outputs	Output interfaces	Analog	Current output: 4 to 20 mA (2 outputs), ^{*4} Maximum load resistance: 270 Ω
		ON/OFF	Open-drain output (2 outputs), ^{*5} 24 VDC 50 mA max. ON residual voltage: 1.5 V max., OFF leakage current: 50 μA max.
		RS-485	2-wire half-duplex communications with start-stop synchronization Baud rate: 115.2 kbps (fixed), Data bit length: 8 bits (fixed), Stop bit length: 1 bit (fixed), Parity: even (fixed), Communications protocol: Conforms to CompoWay/F.
	Output values		Momentary standard flow, total standard flow, pressure, and Sensor error output
Degree of protection		IP64 (Except when switch cover is removed.)	
Wiring connection		M12 connector (8-pin)	
Connection pipe diameter		Rc1 (25A) (Bushing enables conversion to 15A or 20A.)	
Materials		Cable: PVC (polyvinylchloride); Main unit: Aluminum die-cast; Display: Acrylic	
Dimensions		64 × 93 × 195 mm (W×D×H) (excluding flange)	
Weight (in package)		Approx. 1.2 Kg (Approx. 1.7 Kg)	
Accessories		Instruction Sheet	

*1. Flow rates are converted to 1 atmospheric pressure (101.3 kPa) at 20°C.

*2. Does not include pressure and temperature accuracy. Conversion accuracy to the standard flow is ±2.5% of reading (at 20°C, 0.5 MPa).

*3. Always ground the 0 V terminal, and do not ground the 24 V (+) terminal. There is a risk of malfunction.

*4. The analog output is the momentary standard flow rate and pressure.

*5. The total standard flow for the pulse output can be set to 1, 10 (default), 100, or 1,000 L (std) per pulse.

Air Flow Station

Item/Model	D6FZ-FGX21
Connectable Sensors	D6FZ-FGT200, D6FZ-FGT500, and D6FZ-FGS1000
Maximum number of connected Sensors	8*1
Indications	7-segment 5-digit 2-row LCD, auxiliary information indicators
Recording interval	1 s, 2 s, 5 s, 10 s, 20 s, 30 s, or 1 min
Displayed data	Momentary flow rate, total flow rate, pressure, temperature, and billing amount/CO ₂ conversion
Recorded data	Momentary flow rate, total flow rate, volume flow rate, pressure, and temperature
Calculation functions	Conversion of total flow rate to billing amount/CO ₂
Recording modes	Continue Mode*2 and Ring Mode*3
External output	Alarm output (photocoupler output)*4
Communications interface	Ethernet (10Base-T or 100Base-TX)
Internal storage device	Internal memory: Approx. 4,200 data items when 1 Sensor is connected, Approx. 650 data items when 8 Sensors are connected.
External storage device	SD card (to save measured values and to save/read set values), Recommended SD card: HMC-SD291 (manufactured by OMRON)*5
Power supply voltage	DC input: 24 VDC ±10%, ripple (p-p): 10% max.
Current consumption	80 mA max.
Operating temperature	Without Ethernet: -10 to 40°C (with no condensation or icing), with Ethernet: 0 to 40°C (with no condensation or icing)
Operating humidity	35% to 85% RH (with no condensation or icing)
Storage humidity/temperature	-15 to 60°C, 20% to 85% RH (with no condensation or icing)
Insulation resistance	20 MΩ (at 500 VDC)
Withstand voltage	1,000 VAC, 50/60 Hz for 1 min
Vibration resistance (destruction)	10 to 150 Hz with a 0.7-mm double amplitude or acceleration of 50 m/s ² for 80 min each in X, Y, and Z directions
Shock resistance (destruction)	150 m/s ² 3 times each in six directions (up/down, left/right, forward/backward)*6
Material	ABS
Degree of protection	IP30
Mounting method	Magnet mounting, screw mounting, or hooks
Dimensions	117.2 × 24.6 × 56.8 mm (W×D×H) (excluding protruding parts)
Weight (in package)	Approx. 150 g (Approx. 500 g)
Accessories	Instruction Sheet, Startup Guide, Connection Cable,*7 Alarm Output Connector*8

*1. Up to 8 Sensors can be connected when the recording cycle is 2 seconds or longer; up to 4 Sensors can be connected when the recording cycle is 1 second.

*2. Data is automatically written to the SD memory card when the internal memory reaches its capacity and recording continues until the SD memory card capacity is reached. Recording stops if there is no SD memory card inserted, when the internal memory capacity is reached, or when the SD memory card is write protected. (Recording can be resumed after inserting an SD memory card and outputting the data to it by pressing a button.) The default is Continue Mode. Use the PC Software to change the recording mode.

*3. Recording of the latest measured values continues until the internal memory reaches its capacity. (If the internal memory capacity is exceeded, data is overwritten from the oldest data in the memory.)

*4. An alarm is output when the upper or lower limit of the air flow that was set in threshold setting mode is exceeded.

*5. You can temporarily read and write data with an SD card that complies with SD/SDHC card standards and was made by another company, but the SD card may suddenly not be recognized, preventing you from accessing the data.

*6. When mounting the Sensor with magnets, be sure to install it in a location where it will not be subjected to shock.

*7. A T-branch connector to connect to D6FZ-FC02.

*8. OMRON's XW4B-02B1-H1 Connector.

Connections

Connection Diagrams With One Sensor

- ① Cable with Connector on One End
- ② Cable with Connectors on Both Ends

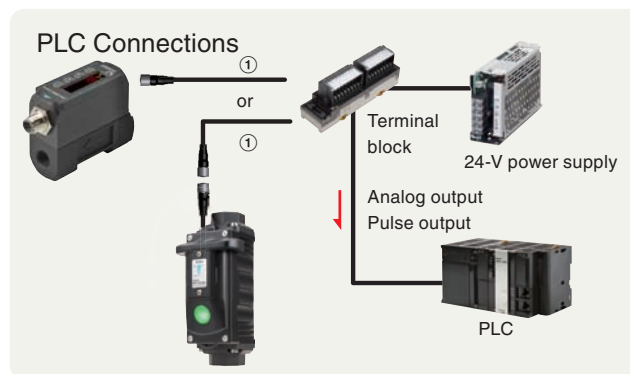
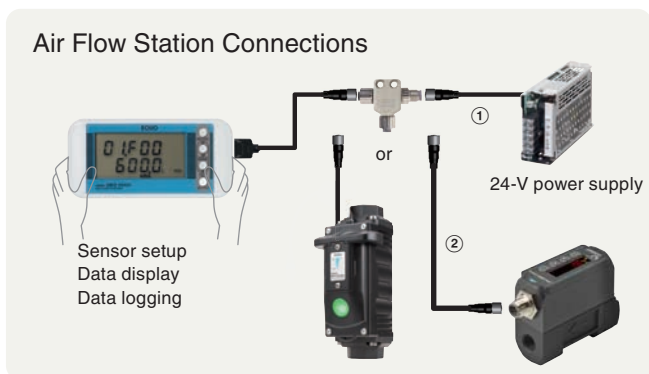

Data Communications with Multiple Sensor Connections

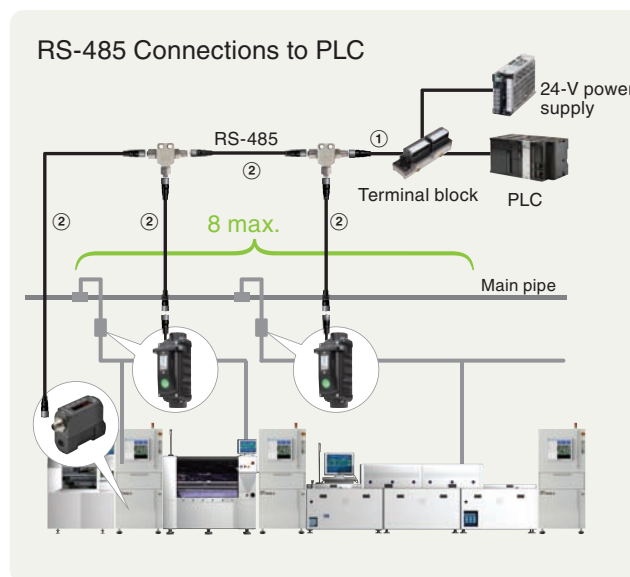
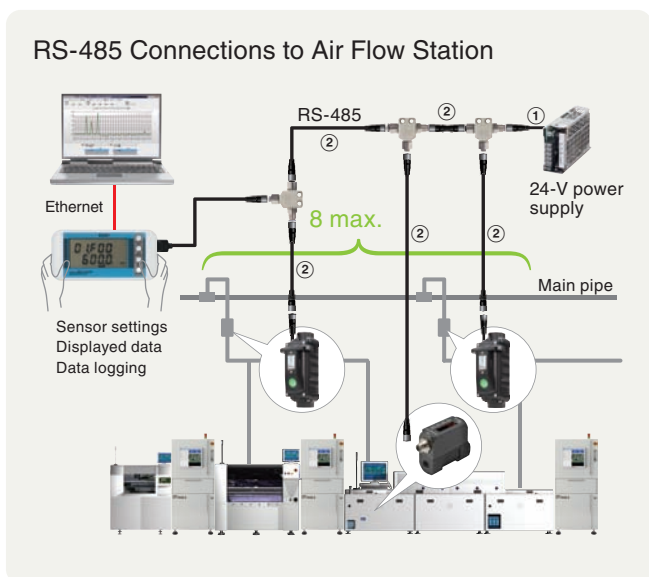

Wireless Data Collection

Ethernet
Wireless Unit Master (LAN)
WZ-MLAN01
Wireless Unit Slave (Pulse Count)
WZ-SP01
Main pipe
Connects to up to 2 Sensors.

The Triple Reliability of the 920 MHz Band

<p>Compared to the 2.4 GHz band:</p>		
<p>The reliability of a longer communications distance.</p>	<p>The reliability of easier bending of waves bend around objects.</p>	<p>The reliability of less interference from other communications devices.</p>

For detailed specifications, consult your OMRON sales representative.

Refer to the user's manuals for the Wireless Unit and Air Flow Sensors for detailed information on connections.

Engineering Data

Pressure Loss* (Typical) D6FZ-FGS1000

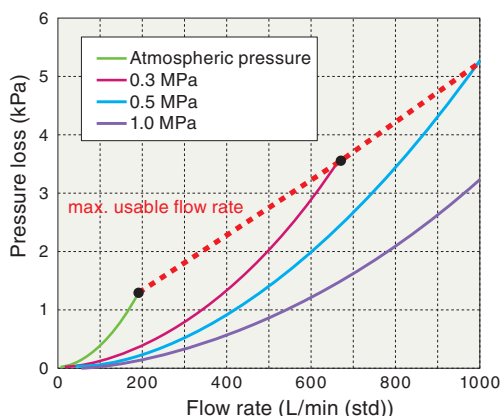

* Note: With direct piping.

D6FZ-FGT200

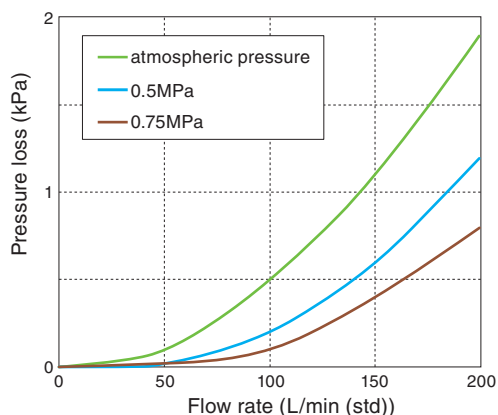

D6FZ-FGT500

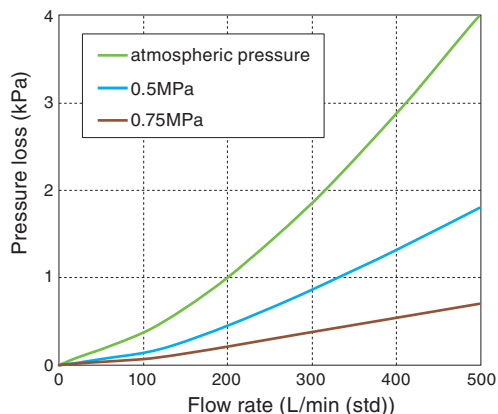

Minimum and Maximum Flow Rate Conversion Table (Typical) D6FZ-FGS1000

Temperature [°C]	Pressure [MPa]	Minimum flow rate [L/min (std)]	Maximum flow rate [L/min (std)]
20	0.3	3.96	667.37
	0.5	5.93	999.94
	0.7	7.91	1000.00
25	0.3	3.89	656.17
	0.5	5.83	983.17
	0.7	7.78	1000.00
30	0.3	3.83	645.35
	0.5	5.74	966.96
	0.7	7.65	1000.00

Flow rate accuracy characteristics for a length of straight pipe D6FZ-FGT Only

The following graph shows the flow rate accuracy characteristics for a length of straight pipe (reference information).

D6FZ-FGT200

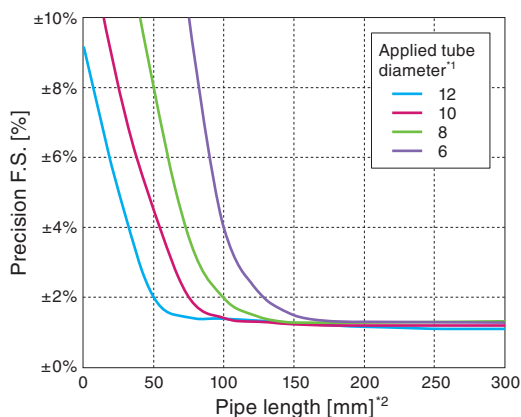

D6FZ-FGT500

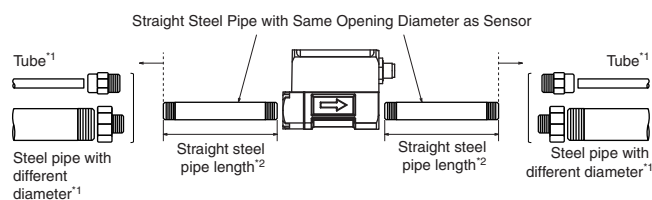
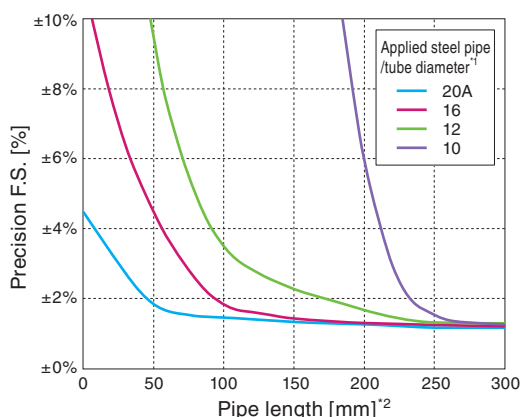

Safety Precautions

Read the warranty and limitations of liability information.

Air Flow Sensors

Warning

This product cannot be used to detect people either directly or indirectly for the purpose of ensuring safety.

Do not use the product as a detector for personal safety.



The use of flammable gases may cause an explosion.

Do not use the product in the presence of flammable gases.



Electric shock may occur. Do not connect the product to an AC power supply.



Caution

Do not use the product in an ambient atmosphere or environment that exceeds the ratings.

Injury may occur due to an explosion.

Flow rates and pressures must be within the specified working ranges.



<D6FZ-FGT only>

If water drops, oil, mist, or dust enters the product, it may result in measurement error or damage. Use clean gas. Dust and mist can affect the characteristics of Sensor or damage the Sensor. Install a filter and mist separator on the upstream tube. Also, install the product after removing any dust in the pipes with an air blow or other means.



Precautions for Correct Use

Precaution for piping

D6FZ-FGT Only

Applicable Opening Diameter: D6FZ-FGT200: 8A, D6FZ-FGT500: 15A

Always use a steel straight or elbow pipe with the same opening diameter. If a steel pipe with a different opening diameter or an air tube joint is required, you can reduce adverse influences by providing a section of straight pipe with the same opening diameter just before and after the Sensor. Refer to *Flow rate accuracy characteristics for a length of straight pipe* on page 10 for the required straight pipe length and measurement accuracy.

Precaution for mounting

Mounting position

- Be sure to mount the body horizontally, otherwise the detection accuracy might be worse.
- Don't mount the body facing the control panel downward. Otherwise, the mist and dust in the pipe accumulates and it might cause breakdown.

<Correct mounting>

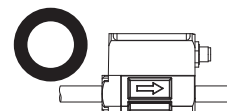

- Mounting the body horizontally
- Control panel Upward

<Incorrect mounting>

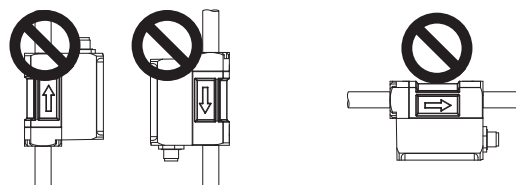

- Mounting the body Vertically
- Control panel Downward

Flowing direction

- An arrow in the side of the body indicates the direction where air flows.
- Be sure to check the direction of the arrow before mounting.
- Mounting in the opposite direction causes mis-measurement.

<The indication of the body>

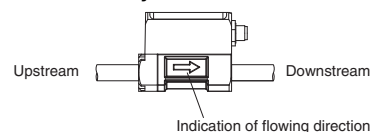

<The relationship between flowing direction and mounting direction>

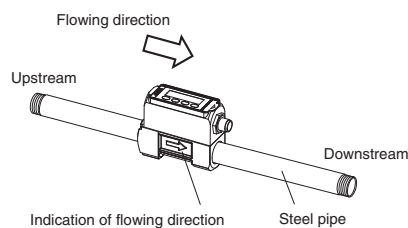

Air Flow Station

Warning

The mounting magnets provided with the product have strong magnetism. If the product is mounted using these magnets, anyone wearing a heart pacemaker must not operate the product. Also, the product must not be brought into the proximity of such a person.



This product contains lithium batteries. Serious injury may occur due to fire or explosion. Do not attempt to disassemble the product, deform it by applying pressure, heat it to a high temperature (100°C or higher), or incinerate it for disposal.



Dimensions

Air Flow Sensor D6FZ-FGT200

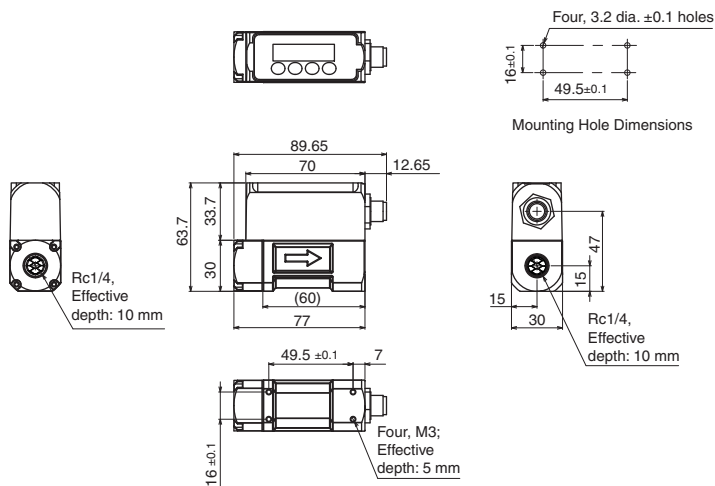

D6FZ-FGT500

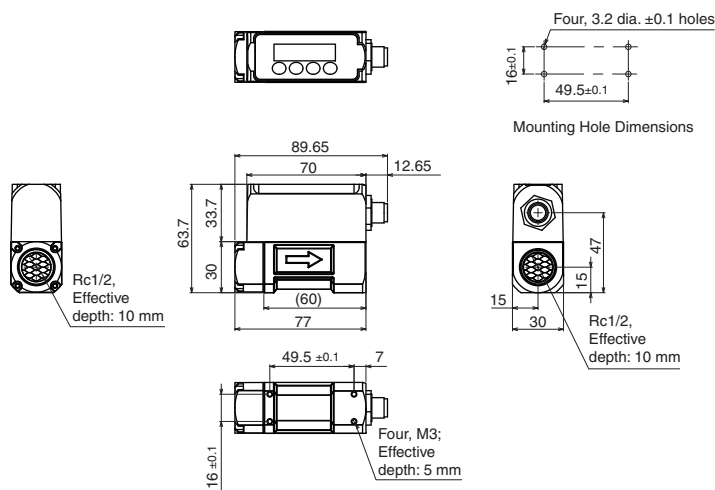

D6FZ-FGS1000

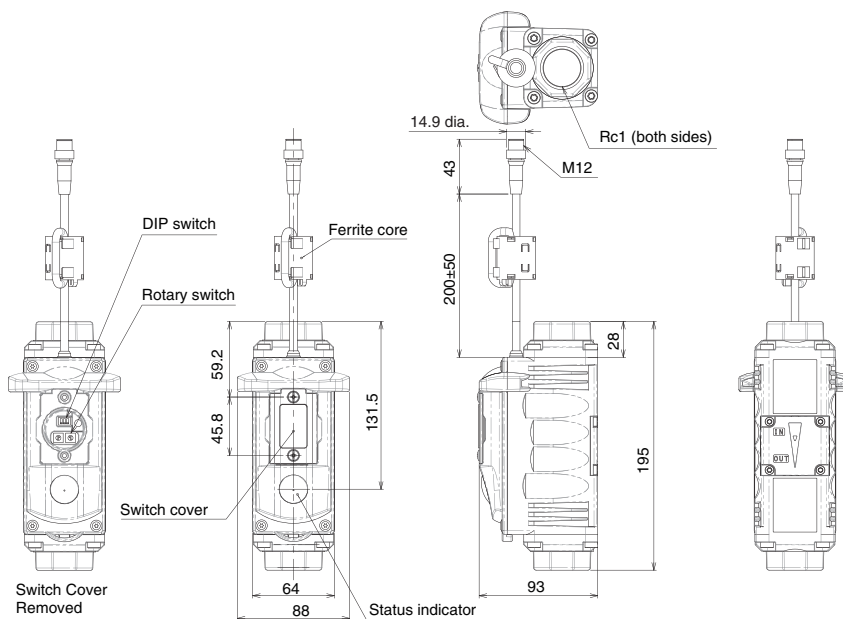

Air Flow Station

D6FZ-FGX21

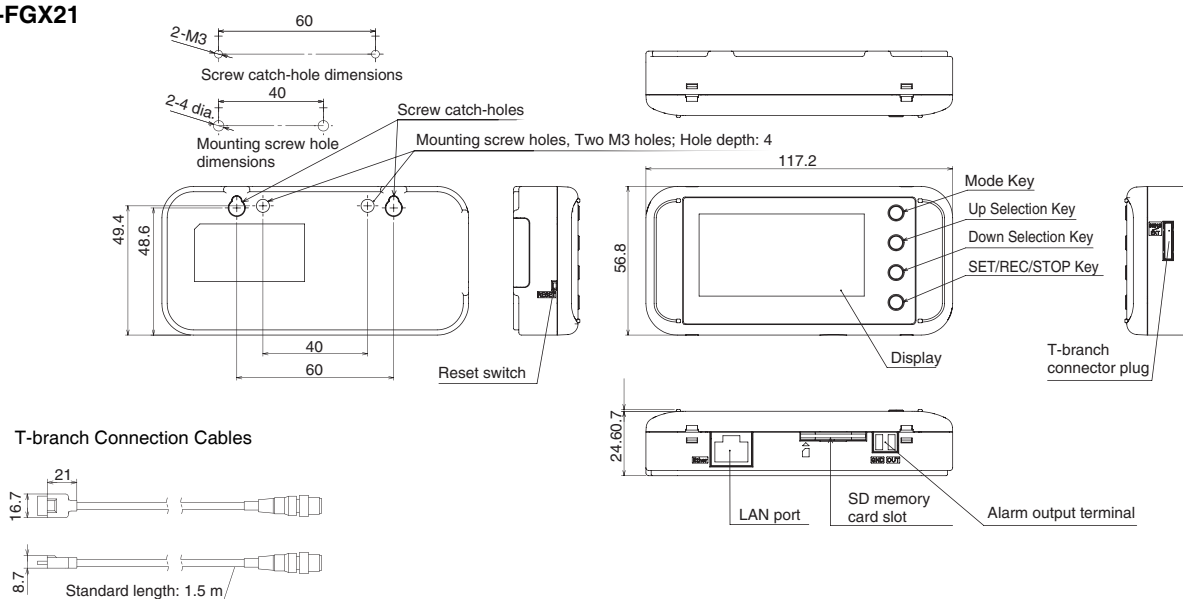

T-branch Connector

D6FZ-FC02

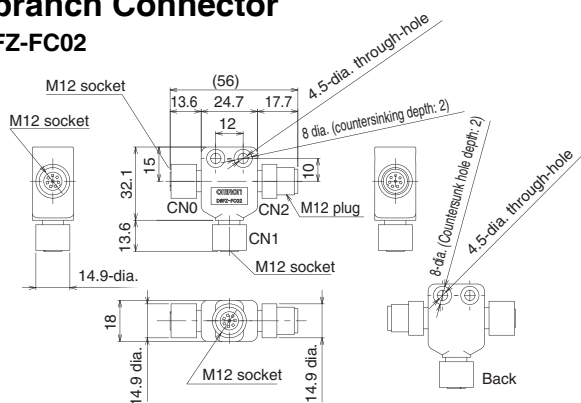

Cables with Connector on One End

- D6FZ-JD3A (L = 3 m)
- D6FZ-JD10A (L = 10 m)
- D6FZ-JD20A (L = 20 m)

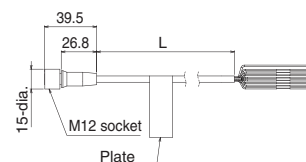

Cables with Connectors on Both Ends

- D6FZ-JD3B (L = 3 m)
- D6FZ-JD5B (L = 5 m)
- D6FZ-JD10B (L = 10 m)
- D6FZ-JD20B (L = 20 m)

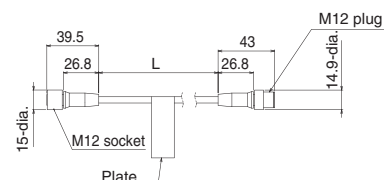

Mounting Bracket

D6FZ-FC03

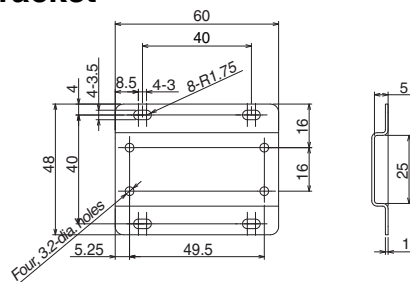

Terms and Conditions Agreement

Read and understand this catalog.

Please read and understand this catalog before purchasing the products. Please consult your OMRON representative if you have any questions or comments.

Warranties.

(a) Exclusive Warranty. Omron's exclusive warranty is that the Products will be free from defects in materials and workmanship for a period of twelve months from the date of sale by Omron (or such other period expressed in writing by Omron). Omron disclaims all other warranties, express or implied.

(b) Limitations. OMRON MAKES NO WARRANTY OR REPRESENTATION, EXPRESS OR IMPLIED, ABOUT NON-INFRINGEMENT, MERCHANTABILITY OR FITNESS FOR A PARTICULAR PURPOSE OF THE PRODUCTS. BUYER ACKNOWLEDGES THAT IT ALONE HAS DETERMINED THAT THE PRODUCTS WILL SUITABLY MEET THE REQUIREMENTS OF THEIR INTENDED USE.

Omron further disclaims all warranties and responsibility of any type for claims or expenses based on infringement by the Products or otherwise of any intellectual property right. (c) Buyer Remedy. Omron's sole obligation hereunder shall be, at Omron's election, to (i) replace (in the form originally shipped with Buyer responsible for labor charges for removal or replacement thereof) the non-complying Product, (ii) repair the non-complying Product, or (iii) repay or credit Buyer an amount equal to the purchase price of the non-complying Product; provided that in no event shall Omron be responsible for warranty, repair, indemnity or any other claims or expenses regarding the Products unless Omron's analysis confirms that the Products were properly handled, stored, installed and maintained and not subject to contamination, abuse, misuse or inappropriate modification. Return of any Products by Buyer must be approved in writing by Omron before shipment. Omron Companies shall not be liable for the suitability or unsuitability or the results from the use of Products in combination with any electrical or electronic components, circuits, system assemblies or any other materials or substances or environments. Any advice, recommendations or information given orally or in writing, are not to be construed as an amendment or addition to the above warranty.

See <http://www.omron.com/global/> or contact your Omron representative for published information.

Limitation on Liability; Etc.

OMRON COMPANIES SHALL NOT BE LIABLE FOR SPECIAL, INDIRECT, INCIDENTAL, OR CONSEQUENTIAL DAMAGES, LOSS OF PROFITS OR PRODUCTION OR COMMERCIAL LOSS IN ANY WAY CONNECTED WITH THE PRODUCTS, WHETHER SUCH CLAIM IS BASED IN CONTRACT, WARRANTY, NEGLIGENCE OR STRICT LIABILITY.

Further, in no event shall liability of Omron Companies exceed the individual price of the Product on which liability is asserted.

Suitability of Use.

Omron Companies shall not be responsible for conformity with any standards, codes or regulations which apply to the combination of the Product in the Buyer's application or use of the Product. At Buyer's request, Omron will provide applicable third party certification documents identifying ratings and limitations of use which apply to the Product. This information by itself is not sufficient for a complete determination of the suitability of the Product in combination with the end product, machine, system, or other application or use. Buyer shall be solely responsible for determining appropriateness of the particular Product with respect to Buyer's application, product or system. Buyer shall take application responsibility in all cases.

NEVER USE THE PRODUCT FOR AN APPLICATION INVOLVING SERIOUS RISK TO LIFE OR PROPERTY OR IN LARGE QUANTITIES WITHOUT ENSURING THAT THE SYSTEM AS A WHOLE HAS BEEN DESIGNED TO ADDRESS THE RISKS, AND THAT THE OMRON PRODUCT(S) IS PROPERLY RATED AND INSTALLED FOR THE INTENDED USE WITHIN THE OVERALL EQUIPMENT OR SYSTEM.

Programmable Products.

Omron Companies shall not be responsible for the user's programming of a programmable Product, or any consequence thereof.

Performance Data.

Data presented in Omron Company websites, catalogs and other materials is provided as a guide for the user in determining suitability and does not constitute a warranty. It may represent the result of Omron's test conditions, and the user must correlate it to actual application requirements. Actual performance is subject to the Omron's Warranty and Limitations of Liability.

Change in Specifications.

Product specifications and accessories may be changed at any time based on improvements and other reasons. It is our practice to change part numbers when published ratings or features are changed, or when significant construction changes are made. However, some specifications of the Product may be changed without any notice. When in doubt, special part numbers may be assigned to fix or establish key specifications for your application. Please consult with your Omron's representative at any time to confirm actual specifications of purchased Product.

Errors and Omissions.

Information presented by Omron Companies has been checked and is believed to be accurate; however, no responsibility is assumed for clerical, typographical or proofreading errors or omissions.