

Machine Automation Controller

NJ/NX Series



NX7
Beyond the highest

Beyond the highest

Machine performance, scalability, stable operation, and productivity improvement and quality control using data. Here is a solution to all these requirements.

MACHINE CONTROL

- ✓ Ideal for large-scale, fast, and highly-accurate control with up to 256 axes
- ✓ Multi motion cycle

FACTORY AUTOMATION

- ✓ Architecture based on Intel® Core™ i7 processor for fast data processing in parallel with machine control

Industry's fastest

Motion control **125μs / 8 axes**



Model	Performance
NX7	4 times faster
NJ5	

Goes beyond machine control concepts with faster and more accurate performance.

Industry's fastest

Basic instructions **0.37ns**

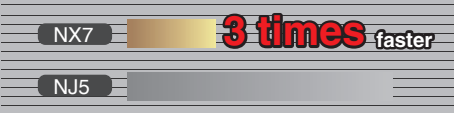

Model	Performance
NX7	3 times faster
NJ5	

Significantly speeds up the execution of instructions. The ever evolving Sysmac architecture inspires your creativity.

Industry's fastest

Ethernet **1Gbps x2**

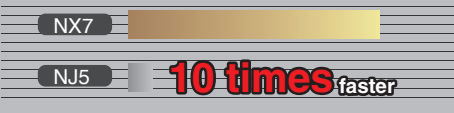

Model	Performance
NX7	10 times faster
NJ5	

Comes standard with two 1 Gbps Ethernet ports. The industry's fastest communication speeds eliminate bottlenecks in data processing.

Largest in class

Memory capacity **260MB**



Model	Performance
NX7	43 times larger
NJ5	

Refocusing on the fundamentals of manufacturing, Omron redefined the specifications. Make your ideas into reality with the NX7.

Note. Based on Omron investigation in March 2015.

Machine Automation Controller

NX7



A fully integrated platform

One machine control through one connection and one software is how we define the Sysmac automation platform. The Machine Automation Controller integrates logic, motion, safety, robotics, vision, information, visualization and networking under one software: Sysmac Studio. This one software provides a true Integrated Development Environment (IDE). The machine controller comes standard with built-in EtherCAT and EtherNet/IP. The two networks with one connection purpose is the perfect match between fast real time machine control and data plant management.

Features

- Complete integration of motion and logic
- A large selection of CPU Units for up to 256 axes
- Fully conforms with IEC 61131-3 standards
- PLCopen Function Blocks for Motion Control
- Integrated Development Environment provided by Sysmac Studio

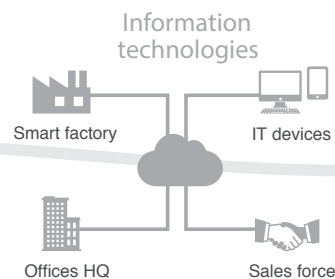

SQL-
Database



N-Smart Fiber/
Laser/
Contact
Sensor



Standard networks

- Built-in EtherCAT and EtherNet/IP™ ports
- EtherCAT: High-speed network to connect a wide range of machine automation devices such as I/O, sensors and drives. Fast, highly accurate control in synchronization with the EtherCAT cycle. Up to 512 slaves
- EtherNet/IP: Based on standard protocols (TCP/IP and UDP/IP). Allows for mixing Ethernet devices and Ethernet applications

Safety integration

- Flexible system lets you integrate safety into machine automation through the use of Safety over EtherCAT (FSoE). Sysmac Studio reduces programming time

NJ CPU Unit with advanced functionality

- Database Connection: Logs real-time data from production lines directly into SQL Databases. This enables preventive maintenance and quality traceability
- Robotics: Controls parallel link robots, cartesian robots and serial link robots
- SECS/GEM: Built-in SECS/GEM communications functions

Sysmac Studio

- Integrates configuration of the NJ/NX Machine Automation Controller and EtherCAT slaves, programming, debugging, and monitoring



Sysmac Studio

Sysmac Library

- The Sysmac Library is a collection of software functional components that can be used in programs for the NJ/NX Machine Automation Controllers. Please download it from following URL and install to Sysmac Studio.
http://www.ia.omron.com/sysmac_library/





Sysmac Library

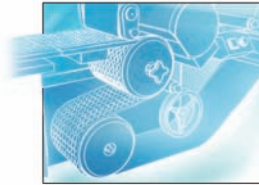

Blistar packaging machines



Filling and capping

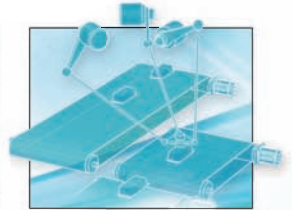

Delta robot picking system

ZW-7000 Displacement Sensor

FH Vision System

Linear motors

IO-Link Master

IO-Link Photoelectric Sensor / Proximity Sensor

Servo drives

Inverters

NX-I/O

NX Safety Control Unit

EtherCAT

NJ/NX Machine Automation Controller



Delta robot

NA Programmable Terminal

EtherNet/IP
Ethernet

Enhanced scalability. Choose the most suitable CPU for your application!



	NX7	NJ5	NJ3	NJ1	NX1P *1
Fastest cycle time	125 μ s	500 μ s	500 μ s	1 ms	2 ms
Number of motion control axes	256, 128 axes	64, 32, 16 axes	8, 4 axes	2, 0 axes	4, 2, 0 axes *2
EtherCAT slaves	512	192	192	64	16
Motion core	Two synchronized motion core	Synchronized motion core	Synchronized motion core	Synchronized motion core	Synchronized motion core

* 1. Refer to NX1P Datasheet (Cat. No.P116).

* 2. Motion control axes and 4 single-axis position control axes.

Motion control

Goes beyond machine control concepts

More sophisticated machines are required for smart manufacturing and collaboration between humans and machines. The new Machine Automation Controller is designed to meet extreme machine control requirements in terms of motion control speed and accuracy, which will help further reduce machine cycle time and improve machine accuracy.

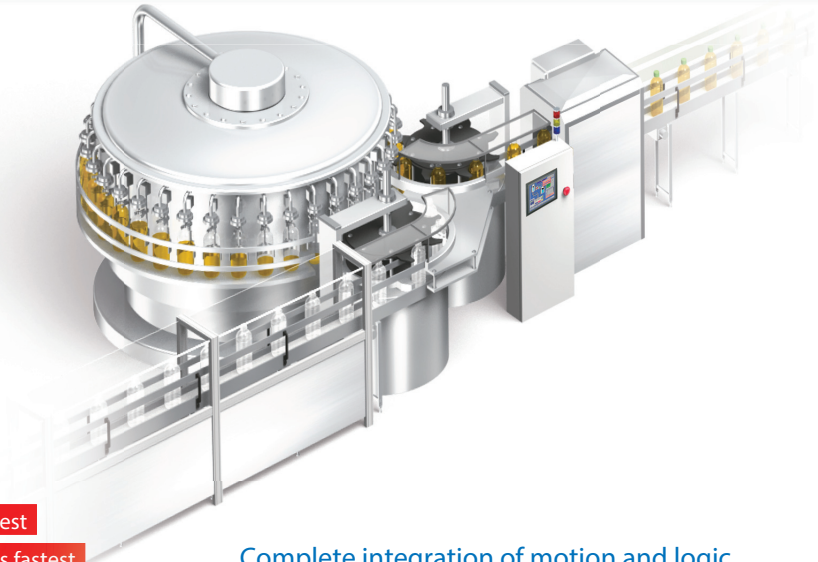

NX701-1□00

Basic instructions 0.37 ns **Industry's fastest**

Motion control 125 μ s/8 axes **Industry's fastest**

Architecture based on Intel® Core™ i7 processor significantly speeds up the execution of instructions (basic instructions 0.37 ns, math instructions for Long Real Data 3.2 ns). Command values to send to servomotors and stepper motors can be updated as fast as every 125 μ s. This enables smooth cam motion and high-precision interpolation and phase adjustment between axes.

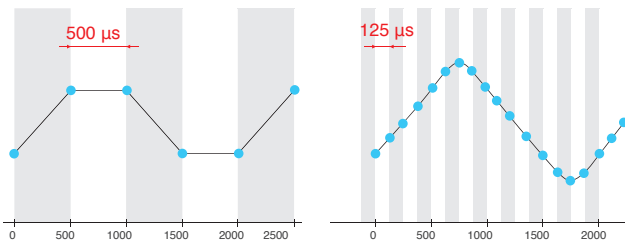

Accurate feedback control with less than 1 μ s jitter

The NJ/NX controller offers synchronous control of all machine devices, from input through to output. Distributed clock-based clock synchronization incorporated into EtherCAT slaves enables the I/O refresh cycle to be synchronized between units such as the FH Vision System, ZW Displacement Sensor, NX I/O, and G5/1S Servo Drive.

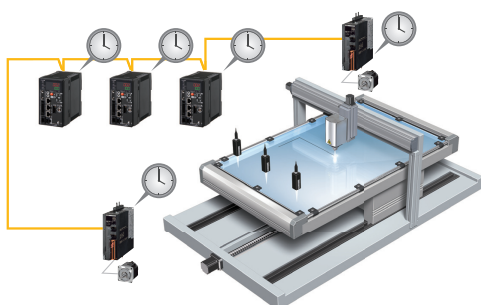

Complete integration of motion and logic

One controller integrates logic, motion, vision and information for complete control and management of machines. Position, displacement, and tension information collected from sensors can be quickly and easily fed back to the motion control.

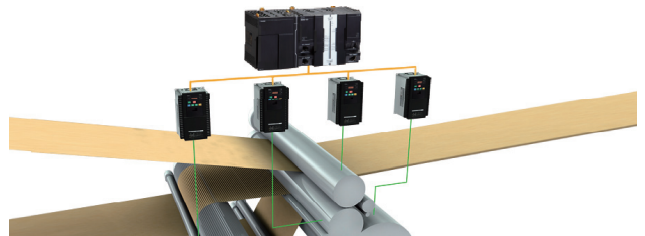

Simlicity for advanced applications

The Sysmac Library is a collection of software functional components that is packed with rich technical know-how on control programs: Rotary knife to cut a film at the marked position and vibration suppression for material handling. This helps create high-performance machines quickly and easily.

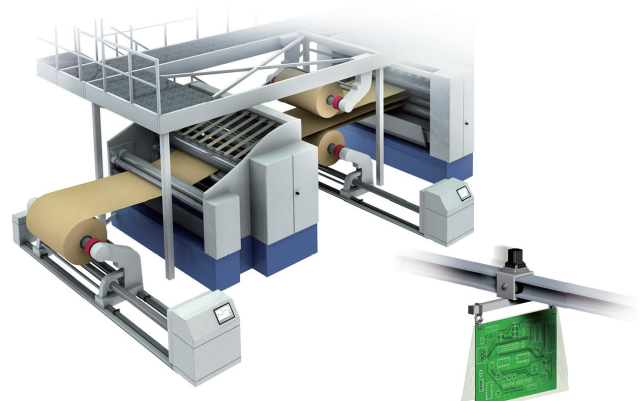

Large data processing

High-speed large data communications and processing in parallel with machine control

Today's manufacturers are under pressure to respond quickly to a wide variety of increasing new consumer needs and to achieve high-quality, zero-defect production. This pressure has prompted them to innovate their production sites by leveraging ICT developments. Featuring a large memory capacity, fast Ethernet connectivity, and multi-core processor, the NX7 allows data processing in parallel with machine control.

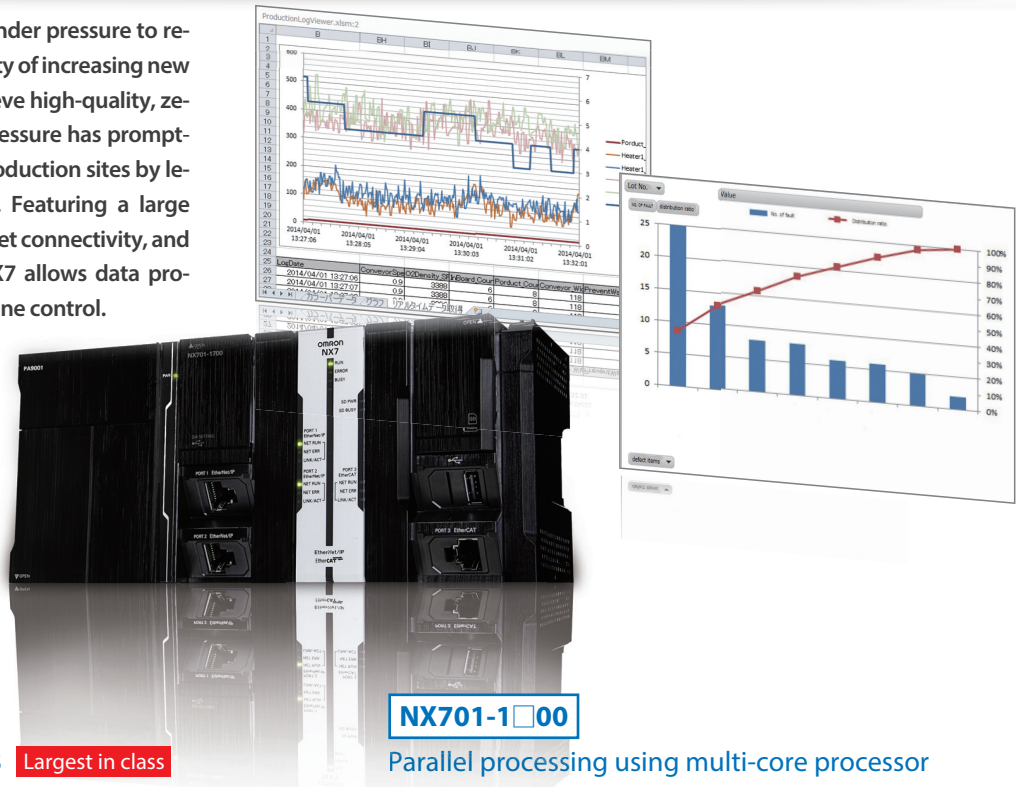
**NX701-1□00**

Memory capacity 260 MB **Largest in class**

Thanks to its large 260 MB memory, the NX7 has sufficient capacity to store increasing recipe data for changeovers and collect large amounts of inspection results and trace data for productivity and quality improvements.

NX701-1□00

Parallel processing using multi-core processor

The Intel® Core™ i7 quad-core processor allows high-speed large data communications and processing in parallel with machine control, without compromising machine performance. It is also possible to add data processing in order to improve production processes.

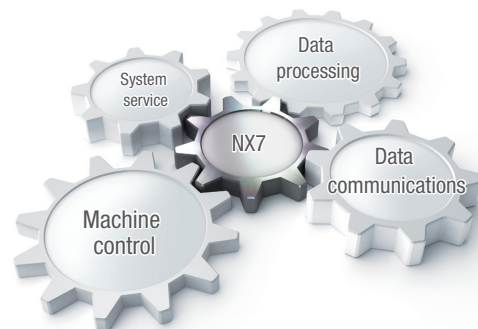
**NX701-1□00**

Ethernet 1Gbps x2 **Industry's fastest**

The NX7 provides two 1 Gbps Ethernet ports and FTP capability to send and receive a large amount of data from/to the host device. The built-in EtherNet/IP port can be used for tag data links or CIP message communications at up to 40,000 pps.



Large scale

Powerful enough to control large production line

Controlling up to 256 synchronized axes, the NX7 simplifies building a large production line.

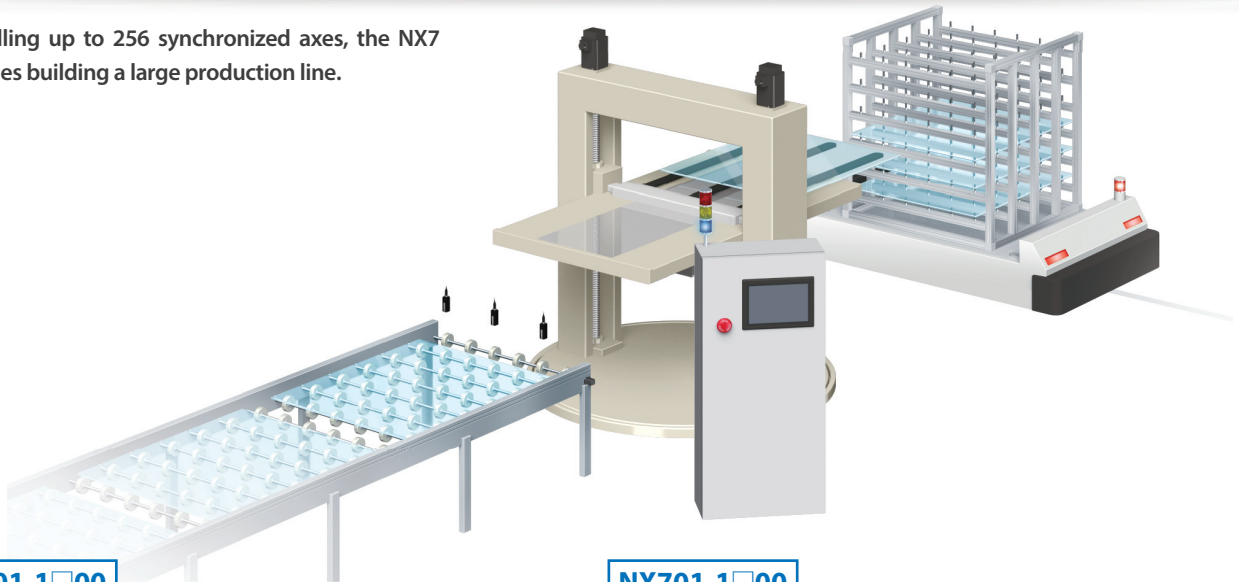

NX701-1□00

Up to 256 synchronized axes

The high-performance NX7 offers synchronous control of all devices on a production line, which previously required multiple controllers. This eliminates the need to implement the synchronization between controllers.

NX701-1□00

Performance improvement

One controller means that interlocks and synchronization between controllers are not required, which will result in an increase in performance of the production line.

NX701-1□00

Simple connection of up to 512 nodes

Up to 512 nodes can be daisy-chained over the EtherCAT network, which helps reduce production line set-up times.

FROM

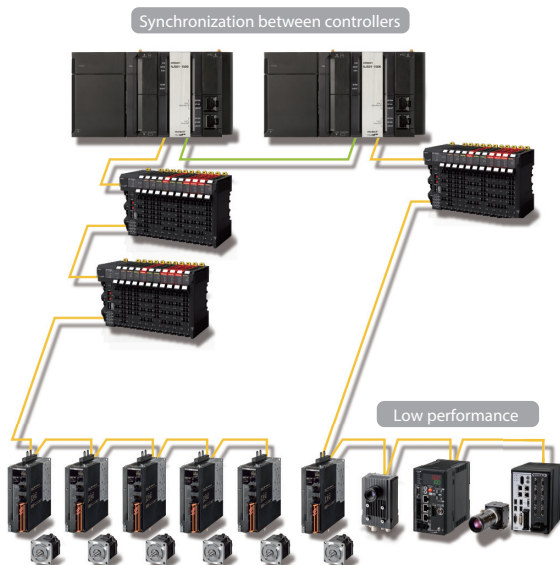

TO

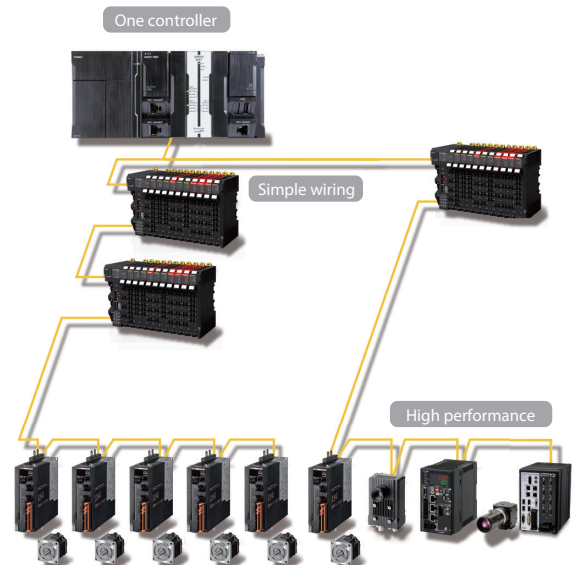

Preventive maintenance

Integrated system for stable operation

Logic, motion, and networking as well as vision, information, safety, and visualization are fully integrated within the Sysmac automation platform. These integrated devices are combined to provide functionality to ensure stable operation of machines and production lines.

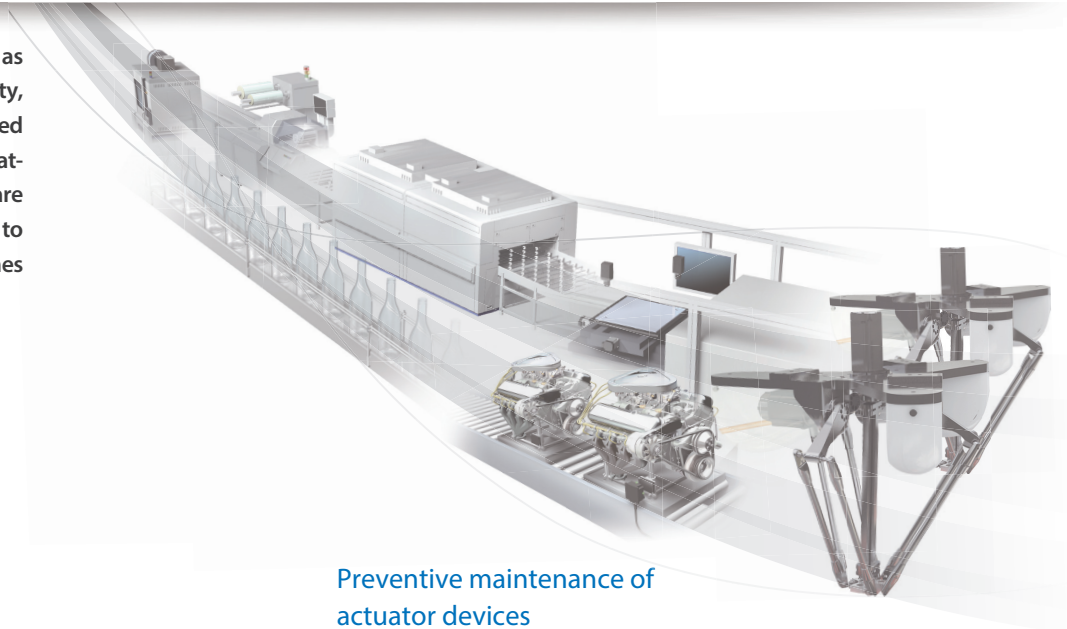

Preventive maintenance of EtherCAT sensor

Monitoring the sensor status allows you to maintain before sensors malfunction due to dirt or aged deterioration.* The sensor settings can be saved and loaded, which minimizes downtime when troubles occur.

TO

Decreases in light intensity can be detected by monitoring sensors.



Initial display



Trend graph

FROM

In harsh environments, sensors can become dirty, resulting in malfunctions.

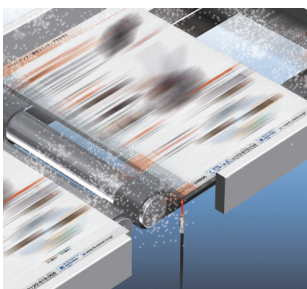

Detection in dusty environment

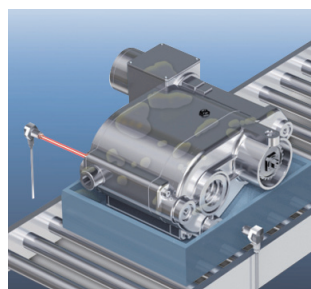

Detection in oily environment

Preventive maintenance of actuator devices

The NJ/NX controller that integrates EtherCAT and motion control can constantly monitor actuator devices with a fast cycle time.



Fully integrated and synchronized

EtherCAT®

NX701-1□00

Example 1 Obtains torque waveform as fast as 125 μs

The NX7 constantly monitors whether the actual torque of the servomotor is within the normal torque range. The fully synchronized system allows data of multiple axes to be analyzed together with the sensor data.

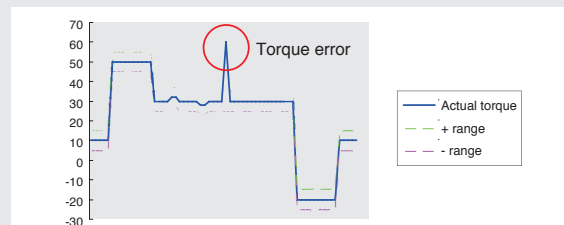

Example 2 Monitors operation counter and response time

Delays in reaction times due to aged deterioration of air cylinders can be detected.

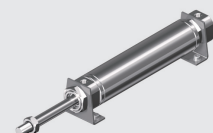

* When combining the NJ/NX controller with the E3NW EtherCAT Sensor communications unit and creating the programmable terminal screens. The sample program for Omron NS/NA Programmable Terminal is available. Contact your Omron sales representative for details.

Creative development environment for globalized manufacturing



Design

Reusable programs

Programming with variables

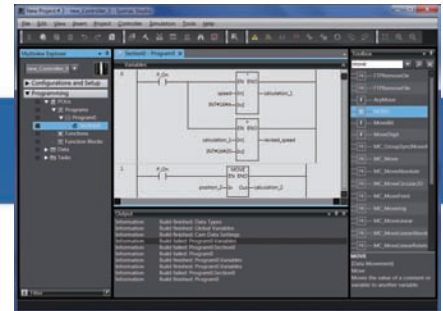

One Integrated Development Environment software Sysmac Studio is fully compliant with the open standard IEC 61131-3. Programming with variables eliminates the need to learn the internal memory map of the PLC and allows the programs to be reused.

Maintenance

Highly efficient maintenance

Troubleshooting

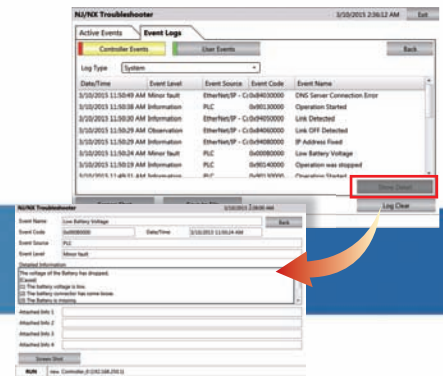

Troubleshooting in the Sysmac Studio and NA Programmable Terminal can manage errors across the entire system including the controller. You can check details of errors and solutions without reading manuals.

For advanced machine control

Library

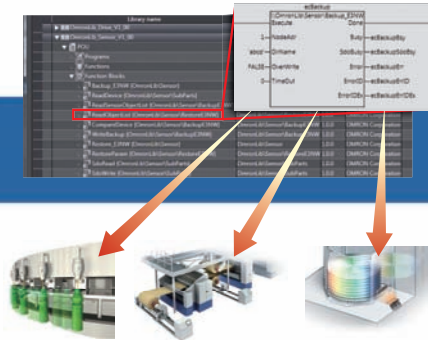

The Sysmac Library is a collection of Function Blocks that is packed with Omron's rich technical know-how on control programs. You can make your own libraries and reuse them to reduce programming and debugging times.

Motion programming



Advanced motion control applications can be created quickly just by combining PLCopen® Function Blocks for Motion Control.

Model-Based design

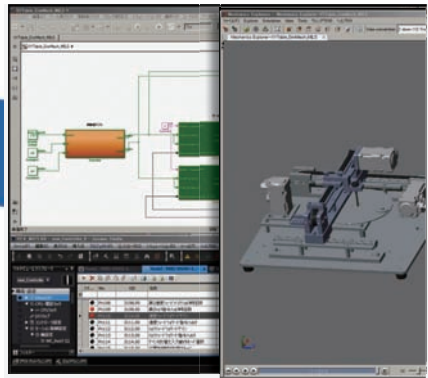

Complex feedback control that is designed with MATLAB®/Simulink® can be imported into programs.



Verification

Fast system debugging

Remote maintenance

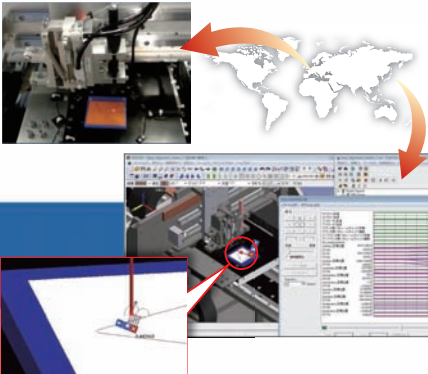

Movement of the machine connected online can be displayed on the CAD in real time, and movement can also be reproduced from the trace data. Maintenance and troubleshooting can be performed in remote locations.

Virtual mechanical debugging

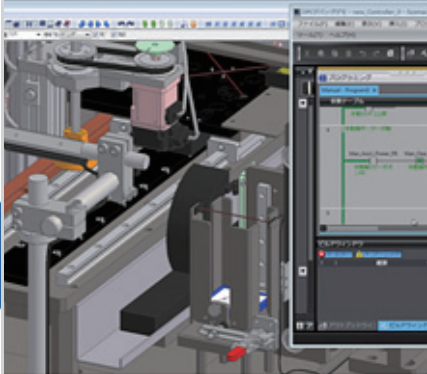

Before the mechanical prototype is completed, motion can be checked and the program can be debugged. This cuts design time.



3D simulation

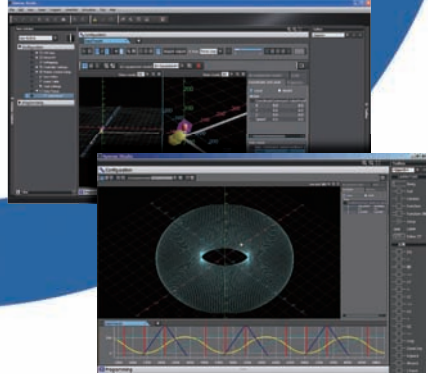

Motion trajectories in 3D can be pre-tested with advanced simulation of sequence and motion control. Simulation of single Function Blocks, POU's (Program Organization Unit) or the entire program can be performed. In addition all standard features such as Break & Step are available. Easy tuning and debugging reduce the set-up times of machines and production lines.

Machine Automation Controller

NJ/NX-Series

New controller that covers functions and high-speed processing required for machine control and safety, reliability and maintainability



NX701-□□□□



NJ501-□□□□

Features

- Integration of Logic and Motion in one CPU.
- Conforms to IEC 61131-3 (JIS B 3503) standard programming and PLCopen function blocks for Motion Control. Programming with variables allows users to create complex programs efficiently.
- Fast and accurate control by synchronizing all EtherCAT devices, such as vision sensors, servo drives, and field devices, with the PLC and Motion Engines.
- Offers speed without compromising on reliability and robustness expected from PLCs.
- Complete RAS functions: Transmission frame error check, timeout, bus diagnosis, Watchdog (WDT), memory check, and topology check, etc.
- Ideal for large-scale, fast, and highly-accurate control with up to 256 axes. (NX701-□□□□)
- Ideal for large-scale, fast, and high-accurate control with up to 64 axes. (NJ501-□□□□)
- Ideal for small-scale control with up to 8 axes. (NJ301-□□□□)
- Ideal for simple machines. (NJ101-□□□□)
- Linear and circular interpolation.
- Electronic gear and cam synchronization.
- The Controller can be directly connected to a database. No special Unit, software, nor middleware is required. (NJ501-□□20/NJ101-□□020)
- The NJ501 SECS/GEM CPU Unit has built-in the SECS/GEM communications functions which are the standards in the semiconductor industry. (NJ501-1340)
- Control function of parallel link robots, cartesian robots and serial link robots. (NJ501-4□□0)

Sysmac is a trademark or registered trademark of OMRON Corporation in Japan and other countries for OMRON factory automation products.
Microsoft, Windows, Windows Vista and SQL Server are registered trademarks of Microsoft Corporation in the United States and other countries.
Oracle and Oracle Database are trademarks or registered trademarks of Oracle Corporation and/or its affiliates in the United States and other countries.
IBM and DB2 are trademarks or registered trademarks of International Business Machines Corp., registered in the United States and other countries.
SEMI® is a trademark or registered trademark of Semiconductor Equipment and Materials International in the United States and other countries.
EtherCAT® is a registered trademark of Beckhoff Automation GmbH for their patented technology.
EtherNet/IP™ and DeviceNet™ are trademarks of ODVA.
Other company names and product names in this document are the trademarks or registered trademarks of their respective companies.

Ordering Information

International Standards

- The standards are abbreviated as follows: U: UL, U1: UL(Class I Division 2 Products for Hazardous Locations), C: CSA, UC: cULus, UC1: cULus(Class I Division 2 Products for Hazardous Locations), CU: cUL, N: NK, L: Lloyd, CE: EU Directives, RCM: Regulatory Compliance Mark and KC: KC Registration.
- Contact your OMRON representative for further details and applicable conditions for these standards.

NX701 CPU Units

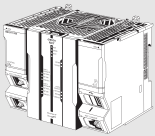
Product Name	Specifications			Current (Power) consumption	Model	Standards
	Program capacity	Memory capacity for variables	Number of motion axes			
 NX701 CPU Units	80 MB	4 MB: Retained during power interruption 256 MB: Not retained during power interruption	256	40 W (including SD Memory Card and End Cover)	NX701-1700	UC1, N, CE, RCM, KC
			128		NX701-1600	

NJ-series CPU Units

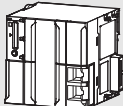
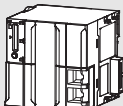
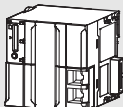
Product name	Specifications				Current consumption (A)		Model	Standards	
	I/O capacity / maximum number of configuration Units (Expansion Racks)	Program capacity	Memory capacity for variables	Number of motion axes	5 VDC	24 VDC			
 NJ501 CPU Units	2,560 points / 40 Units (3 Expansion Racks)	20 MB	2 MB: Retained during power interruption 4 MB: Not retained during power interruption	64	1.90	---	NJ501-1500	UC1, N, L, CE, RCM, KC	
				32					NJ501-1400
				16					NJ501-1300
 NJ301 CPU Units	2,560 points / 40 Units (3 Expansion Racks)	5 MB	0.5 MB: Retained during power interruption 2 MB: Not retained during power interruption	8	1.90	---	NJ301-1200	UC1, N, L, CE, RCM, KC	
				4					NJ301-1100
 NJ101 CPU Units	2,560 points / 40 Units (3 Expansion Racks)	3 MB	2 MB: Not retained during power interruption	2	1.90	---	NJ101-1000	UC1, N, L, CE, RCM, KC	
				0					NJ101-9000

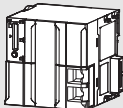
Product name	Specifications							Current consumption (A)		Model	Standards	
	I/O capacity / maximum number of configuration Units (Expansion Racks)	Program capacity	Memory capacity for variables	Number of motion axes	Database Connection function	SECS/GEM Communication function	Number of controlled robots	5 VDC	24 VDC			
 NJ-series Database Connection CPU Units	2,560 points / 40 Units (3 Expansion Racks)	20 MB	2 MB: Retained during power interruption 4 MB: Not retained during power interruption	64	Yes	No	---	1.90	---	NJ501-1520	UC1, N, L, CE, RCM, KC	
				32								NJ501-1420
				16								NJ501-1320
		3 MB	0.5 MB: Retained during power interruption 2 MB: Not retained during power interruption	2								NJ101-1020
				0								NJ101-9020

NJ/NX-Series

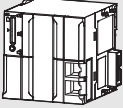
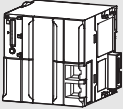
Product name	Specifications							Current consumption (A)		Model	Standards		
	I/O capacity / maximum number of configuration Units (Expansion Racks)	Program capacity	Memory capacity for variables	Number of motion axes	Database Connection function	SECS/GEM Communication function	Number of controlled robots	5 VDC	24 VDC				
NJ-series SECS/GEM CPU Unit 	2,560 points / 40 Units (3 Expansion Racks)	20 MB	2 MB: Retained during power interruption 4 MB: Not retained during power interruption	16	No	Yes	---	1.90	---	NJ501-1340	UC1, N, L, CE, RCM, KC		
NJ-series NJ Robotics CPU Units 				64						No		8 max.*	NJ501-4500
				32									NJ501-4400
				16	Yes	8 max.*	NJ501-4300						
							1			NJ501-4310			
							8 max.*			NJ501-4320			

* The number of controlled robots varies according to the number of axes used for the system.

NX1P2 CPU Units

The compact entry model NX1P2 CPU Unit is also available. Refer to NX1P Catalog (Cat. No. P115).

Automation Software Sysmac Studio

Please purchase a DVD and required number of licenses the first time you purchase the Sysmac Studio. DVDs and licenses are available individually. Each model of licenses does not include any DVD.

Product name	Specifications	Current consumption (A)		Model	Standards
		Number of licenses	Media		
Sysmac Studio Standard Edition Ver.1.□□	The Sysmac Studio is the software that provides an integrated environment for setting, programming, debugging and maintenance of machine automation controllers including the NJ/NX-series CPU Units, NY-series Industrial PC, EtherCAT Slave, and the HMI.	— (Media only)	DVD	SYSMAC-SE200D	—
	Sysmac Studio runs on the following OS. Windows 7(32-bit/64-bit version)/Windows 8(32-bit/64-bit version)/ Windows 8.1(32-bit/64-bit version)/Windows 10(32-bit/64-bit version) The Sysmac Studio Standard Edition DVD includes Support Software to set up EtherNet/IP Units, DeviceNet slaves, Serial Communications Units, and Support Software for creating screens on HMIs (CX-Designer). For details, refer to the Sysmac Integrated Catalogue (P072).	1 license *	—	SYSMAC-SE201L	—

* Multi licenses are available for the Sysmac Studio (3, 10, 30, or 50 licenses).

Collection of software functional components Sysmac Library

Please download it from following URL and install to Sysmac Studio.

http://www.ia.omron.com/sysmac_library/

Typical Models

Product	Features	Model
Vibration Suppression Library	The Vibration Suppression Library is used to suppress residual vibration caused by the operation of machines.	SYSMAC-XR006
Device Operation Monitor Library	The Device Operation Monitor Library is used to monitor the operation of devices such as air cylinders, sensors, motors, and other devices.	SYSMAC-XR008
Dimension Measurement Library	The Dimension Measurement Library is used to dimension measurement with ZW-7000/5000 Confocal Fiber Displacement Sensor, or E9NC-TA0 Contact-Type Smart Sensor.	SYSMAC-XR014

SECS/GEM Configurator

Please purchase the required number of SECS/GEM Configurator licenses and a Sysmac Studio Standard Edition DVD the first time you purchase the SECS/GEM Configurator.

The Sysmac Studio Standard Edition DVD includes the SECS/GEM Configurator. The license does not include the DVD.

Product Name	Specifications	Specifications		Model	Standards
		Number of licenses	Media		
SECS/GEM Configurator Ver.1.□□	<p>The SECS/GEM Configurator is the software to make HSMS, SECSII and GEM settings for NJ501 SECS/GEM CPU Units.</p> <p>The SECS/GEM Configurator runs on the following OS. Windows XP (Service Pack3 or higher, 32-bit edition), Windows Vista (32-bit edition), or Windows 7 (32-bit or 64-bit edition)</p> <p>The software is included in the Sysmac Studio Standard Edition DVD.</p>	1 license	---	WS02-GCTL1	---

Recommended EtherCAT and EtherNet/IP Communications Cables





Use a straight STP (shielded twisted-pair) cable of category 5 or higher with double shielding (aluminum tape and braiding) for EtherCAT.

For EtherNet/IP, required specification for the communications cables varies depending on the baud rate.

For 100BASE-TX/10BASE-T, use a straight or cross STP (shielded twisted-pair) cable of category 5 or higher.

For 1000BASE-T, use a straight or cross STP cable of category 5e or higher with double shielding (aluminum tape and braiding).

Cable with Connectors

Item		Recommended manufacturer	Cable length (m)	Model
Wire Gauge and Number of Pairs: AWG26, 4-pair Cable Cable Sheath material: LSZH *2	Cable with Connectors on Both Ends (RJ45/RJ45) Standard RJ45 plug type *1 Cable color: Yellow *3 	OMRON	0.3	XS6W-6LSZH8SS30CM-Y
			0.5	XS6W-6LSZH8SS50CM-Y
			1	XS6W-6LSZH8SS100CM-Y
			2	XS6W-6LSZH8SS200CM-Y
			3	XS6W-6LSZH8SS300CM-Y
Wire Gauge and Number of Pairs: AWG22, 2-pair Cable	Cable with Connectors on Both Ends (RJ45/RJ45) Rugged RJ45 plug type *1 Cable color: Light blue 	OMRON	0.3	XS5W-T421-AMD-K
			0.5	XS5W-T421-BMD-K
			1	XS5W-T421-CMD-K
			2	XS5W-T421-DMD-K
			5	XS5W-T421-GMD-K
	Cable with Connectors on Both Ends (M12 Straight/M12 Straight) Shield Strengthening Connector cable *4 M12/Smartclick Connectors Cable color: Black 	OMRON	0.5	XS5W-T421-BM2-SS
			1	XS5W-T421-CM2-SS
			2	XS5W-T421-DM2-SS
			3	XS5W-T421-EM2-SS
			5	XS5W-T421-GM2-SS
	Cable with Connectors on Both Ends (M12 Straight/RJ45) Shield Strengthening Connector cable *4 M12/Smartclick Connectors Rugged RJ45 plug type Cable color: Black 	OMRON	0.5	XS5W-T421-BMC-SS
			1	XS5W-T421-CMC-SS
			2	XS5W-T421-DMC-SS
			3	XS5W-T421-EMC-SS
			5	XS5W-T421-GMC-SS
			10	XS5W-T421-JMC-SS

*1. Cables with standard RJ45 plugs are available in the following lengths: 0.2 m, 0.3 m, 0.5 m, 1 m, 1.5 m, 2 m, 3 m, 5 m, 7.5 m, 10 m, 15 m, 20 m. Cables with rugged RJ45 plugs are available in the following lengths: 0.3 m, 0.5 m, 1 m, 2 m, 3 m, 5 m, 10 m, 15 m.

For details, refer to the *Industrial Ethernet Connectors Catalog* (Cat. No. G019).

*2. The lineup features Low Smoke Zero Halogen cables for in-cabinet use and PUR cables for out-of-cabinet use. Although the LSZH cable is single shielded, its communications and noise characteristics meet the standards.

*3. Cable colors are available in yellow, green, and blue.

*4. For details, contact your OMRON representative.

NJ/NX-Series

Cables / Connectors

Item		Recommended manufacturer	Model
Products for EtherCAT or EtherNet/IP (1000BASE-T*2/100BASE-TX)	Wire Gauge and Number of Pairs: AWG24, 4-pair Cable	Cables	Hitachi Cable, Ltd. NETSTAR-C5E SAB 0.5 × 4P *1
			Kuramo Electric Co. KETH-SB *1
			SWCC Showa Cable Systems Co. FAE-5004 *1
Products for EtherCAT or EtherNet/IP (100BASE-TX/10BASE-T)	Wire Gauge and Number of Pairs: AWG22, 2-pair Cable	RJ45 Connectors	Panduit Corporation MPS588-C *1
		Cables	Kuramo Electric Co. KETH-PSB-OMR *3
		RJ45 Assembly Connector	JMACS Japan Co., Ltd. PNET/B *3
		OMRON XS6G-T421-1 *3	

*1. We recommend you to use the above Cable and RJ45 Connector together.

*2. The products can be used only with the NX701.

*3. We recommend you to use the above Cable and RJ45 Assembly Connector together.

Memory Card

Item	Specification	Model
Memory Card	SD Memory Card, 2 GB	HMC-SD291*
	SDHC Memory Card, 4 GB	HMC-SD491

* HMC-SD291 cannot be used for the NJ501-□□□□ hardware revision A/unit version 1.15 or later.

Accessories

The following accessories come with the CPU Unit.

Item	Specification	
	NX-series	NJ-series
Battery	CJ1W-BAT01	
End Cover	NX-END01 (must be attached to the right end of the CPU Rack)	CJ1W-TER01 (must be attached to the right end of the CPU Rack)
End Plate	---	PFP-M (2 required)
Fan Unit	NX-FAN01	---
SD Memory Card (Flash Memory)	---	HMC-SD291*

* NJ501-□□20 or NJ101-□□20 or NJ501-1340 only.

HMC-SD491 is provided with NJ501-□□20 and NJ501-1340 hardware revision A/unit version 1.15 or later.

General Specifications

Item	NX701-□□□□	NJ501-□□□□	NJ301-□□□□	NJ101-□□□□
Enclosure	Mounted in a panel			
Grounding Method	Ground to less than 100 Ω			
Dimensions (height×depth×width)	100 mm × 100 mm × 132 mm	90 mm × 90 mm × 90 mm		
Weight	880 g (including the End Cover)	550 g (including the End Cover)		
Current Consumption	---	5 VDC, 1.90 A (including SD Memory Card and End Cover)		
Power consumption	40 W (including SD Memory Card and End Cover)	---		
Operation Environment	Ambient Operating Temperature	0 to 55°C		
	Ambient Operating Humidity	10% to 95% (with no condensation)	10% to 90% (with no condensation)	
	Atmosphere	Must be free from corrosive gases.		
	Ambient Storage Temperature	-25 to 70°C (excluding battery and fan unit)	-20 to 75°C (excluding battery)	
	Altitude	2,000 m or less		
	Pollution Degree	2 or less: Conforms to JIS B3502 and IEC 61131-2.		
	Noise Immunity	2 kV on power supply line (Conforms to IEC 61000-4-4.)		
	Overvoltage Category	Category II: Conforms to JIS B3502 and IEC 61131-2.		
	EMC Immunity Level	Zone B		
	Vibration Resistance	Conforms to IEC 60068-2-6. 5 to 8.4 Hz with 3.5-mm amplitude, 8.4 to 150 Hz Acceleration of 9.8 m/s ² for 100 min in X, Y, and Z directions (10 sweeps of 10 min each = 100 min total)		
Shock Resistance	Conforms to IEC 60068-2-27. 147 m/s ² , 3 times in X, Y, and Z directions (100 m/s ² for Relay Output Units)			
Battery	Life	2.5 years (at 25°C, Power ON time rate 0% (power OFF))	5 years at 25°C	
	Model	CJ1W-BAT01		
Applicable Standards	Conforms to cULus, NK *1, EU Directives, RCM and KC Registration.		Conforms to cULus, NK, LR, EU Directives, RCM and KC Registration *2.	

*1. Supported only by the CPU Units manufactured in December 2016 or later.

*2. Supported only by the CPU Units with unit version 1.01 or later.

Performance Specifications

Item			NX701-		NJ501-			NJ301-		NJ101		
			1700	1600	□5□0	□4□0	□3□0	1200	1100	1□□0	9□□0	
Processing Time	Instruction Execution Times	LD instruction	0.37ns or more		1.1ns (1.7ns or less)			2.0ns (3.0ns or less)		3.3ns (5.0ns or less)		
		Math Instructions (for Long Real Data)	3.2ns ns or more		24ns or more *1			42 ns or more		70 ns or more		
Programming	Program capacity *2	Size	80 MB (1600 KS)		20 MB (400 KS)			5 MB (100 KS)		3 MB (60 KS)		
		Number	POU definition	6,000		3,000			750		450	
			POU instance	48,000		Using Sysmac Studio Ver. 1.05 or lower : 6,000 Using Sysmac Studio Ver. 1.06 or higher : 9,000			Using Sysmac Studio Ver. 1.04 or lower : 1,500 Using Sysmac Studio Ver. 1.05 or higher : 3,000		1,800	
		Variables capacity	No Retain Attribute *3	Size	256 MB		4 MB			2 MB		
	Number			360,000		90,000			22,500			
	Retain Attribute *4		Size	4 MB		2 MB			0.5 MB			
			Number	40,000		10,000			Using Sysmac Studio Ver. 1.04 or lower : 2,500 Using Sysmac Studio Ver. 1.05 or higher : 5,000		5,000	
	Data type	Number	8,000		2,000			1,000				
	Memory for CJ-Series Units (Can be Specified with AT Specifications for Variables.)	CIO Area	---		6,144 words (CIO 0 to CIO 6143)							
		Work Area	---		512 words (W0 to W511)							
		Holding Area	---		1,536 words (H0 to H1535)							
		DM Area	---		32,768 words (D0 to D32767)							
EM Area		---		32,768 words × 25 banks (E0_00000 to E18_32767) *5			32,768 words × 4 banks (E0_00000 to E3_32767) *5					
Unit Configuration	Maximum Number of Connectable Units	Maximum number of CJ/NX unit per CPU Rack or Expansion Rack	---		10 Units							
		Maximum number of CJ unit on the system	---		40 Units							
		Maximum number of NX unit on the system	4,096 (on NX series EtherCAT slave terminal)							400 (on NX series EtherCAT slave terminal)		
	Maximum number of Expansion Racks	0		3 max.								
	I/O Capacity	Maximum number of I/O Points on CJ-series Units		---		2,560 points max.						
	Power Supply Unit for CPU Rack and Expansion Racks	Model		NX-PA9001 NX-PD7001		NJ-P□3001						
Power OFF Detection Time		AC Power Supply	30 to 45 ms		30 to 45 ms							
	DC Power Supply	5 to 20ms		22 to 25 ms								

*1. When the hardware revision for the Unit is A.

*2. This is the capacity for the execution objects and variable tables (including variable names).

*3. Words for CJ-series Units in the Holding, DM, and EM Areas are not included.

*4. Words for CJ-series Units in the CIO and Work Areas are not included.

*5. When the Spool function of the NJ501-1□20 is enabled, the DB Connection Service uses E9_0 to E18_32767 (NJ501-1□20).
When the Spool function of the NJ101-□□20 is enabled, the DB Connection Service uses E1_0 to E3_32767 (NJ101-□□20).

Item			NX701-		NJ501-			NJ301-		NJ101		
			1700	1600	□5□0	□4□0	□3□0	1200	1100	1□□0	9□□0	
Motion Control	Number of Controlled Axes	Maximum Number of Controlled Axes	Maximum number of axes which can be defined. The number of controlled axes = The number of motion control axes + The number of single-axis position control axes									
			256 axes	128 axes	64 axes	32 axes	16 axes	15 axes *6	15 axes *6	6 axes		
		Motion control axes	Maximum number of motion control axes which can be defined. All motion control function is available.									
			256 axes	128 axes	64 axes	32 axes	16 axes	15 axes	15 axes	6 axes		
		Maximum number of used real axes	Maximum number of used real axes. The Number of used real axes includes following servo axes and encoder axes.									
			256 axes	128 axes	64 axes	32 axes	16 axes	8 axes	4 axes	2 axes		
	Used motion control servo axes	Maximum number of servo axes which all motion control function is available. The number of used motion control servo axes = The number of motion control axes whose axis type is set to servo axis and axis use is set to used axis.										
		256 axes	128 axes	64 axes	32 axes	16 axes	8 axes	4 axes	2 axes			
	Maximum number of axes for linear interpolation axis control		4 axes per axes group									
	Number of axes for circular interpolation axis control		2 axes per axes group									
	Maximum Number of Axes Groups			64 groups			32 groups					
	Motion Control Period			The same control period as that is used for the process data communications cycle for EtherCAT.								
	Cams	Number of Cam Data Points	Maximum Points per Cam Table	65,535 points								
Maximum Points for All Cam Tables			1,048,560 points			1,048,560 points			262,140 points			
Maximum Number of Cam Tables		640 tables			640 tables			160 tables				
Position Units			Pulses, millimeters, micrometers, nanometers, degrees or inches									
Override Factors			0.00% or 0.01% to 500.00%									
Peripheral USB Port	Supported Services		Sysmac Studio connection									
	Physical Layer		USB 2.0-compliant B-type connector									
	Transmission Distance between Hub and Node		5 m max.									

*6 This number of axes is achieved in a combination of a CPU Unit with unit version 1.06 or later and Sysmac Studio version 1.07 or higher. In other combinations, the maximum number of controlled axes is 8 axes (NJ301-1200) or 4 axes (NJ301-1100).

NJ/NX-Series

Item		NX701-		NJ501-			NJ301-		NJ101		
		1700	1600	□5□0	□4□0	□3□0	1200	1100	1□□0	9□□0	
Built-in EtherNet/IP Port	Number of port	2		1							
	Physical Layer	10BASE-T/ 100BASE-TX / 1000BASE-T		10Base-T or 100Base-TX							
	Frame length	1514 max.									
	Media Access Method	CSMA/CD									
	Modulation	Baseband									
	Topology	Star									
	Baud Rate	1Gbps (1000BASE-T)		100 Mbps (100Base-TX)							
	Transmission Media	STP (shielded, twisted-pair) cable of Ethernet category 5, 5e or higher									
	Maximum Transmission Distance between Ethernet Switch and Node	100m									
	Maximum Number of Cascade Connections	There are no restrictions if Ethernet switch is used.									
	CIP service: Tag Data Links (Cyclic Communications)	Maximum Number of Connections	256 / port total 512		32						
		Packet interval *7	0.5 to 10,000 ms in 0.5-ms increments Can be set for each connection.		1 to 10,000 ms in 1.0-ms increments *8 Can be set for each connection. (Data will be refreshed at the set interval, regardless of the number of nodes.)						
		Permissible Communications Band	40,000 pps *9 including heartbeat		3,000 pps *9 *10 (including heartbeat)						
		Maximum Number of Tag Sets	256 / port total 512		32						
		Tag types	Network variables		Network variables, CIO, Work, Holding, DM, and EM Areas						
		Number of tags per connection (i.e., per tag set)	8 (7 tags if Controller status is included in the tag set.)								
		Maximum Link Data Size per Node (total size for all tags)	256 / port total 512		256						
		Maximum number of tag	369,664 byte (Total in 2 ports 739,328 byte)		19,200 bytes						
		Maximum Data Size per Connection	1,444 byte		600 bytes						
		Maximum Number of Registrable Tag Sets	256 / port total 512 (1 connection = 1 tag set)		32 (1 connection = 1 tag set)						
		Maximum Tag Set Size	1,444 bytes (Two bytes are used if Controller status is included in the tag set.)		600 bytes (Two bytes are used if Controller status is included in the tag set.)						
Multi-cast Packet Filter *11	Supported.										
Cip Message Service: Explicit Messages	Class 3 (number of connections)	128 / port total 256 (clients plus server)		32 (clients plus server)							
	UCMM (non-connection type)	Maximum Number of Clients that Can Communicate at One Time	32 / port total 64		32						
		Maximum Number of Servers that Can Communicate at One Time	32 / port total 64		32						
Maximum number of TCP socket service	30		30 *12					30			

*7. Data is updated on the line in the specified interval regardless of the number of nodes.

*8. The Packet interval of the CPU Unit version 1.02 or earlier is 10 to 10,000 ms in 1.0-ms increments.

*9. Means packets per second, i.e., the number of communications packets that can be sent or received in one second.

*10. The Permissible Communications Band of the CPU Unit version 1.02 or earlier is 1,000 pps.

*11. An IGMP client is mounted for the EtherNet/IP port. If an ethernet switch that supports IGMP snooping is used, filtering of unnecessary multicast packets is performed.

*12. The Maximum number of TCP socket service of the CPU Unit version 1.02 or earlier is 16.

Note: For robot control by NJ501-4□□□, use the G5 series/1S series AC Servo Drive with built-in EtherCAT communications, absolute encoder, and brake.

Item		NX701-		NJ501-			NJ301-		NJ101		
		1700	1600	□5□0	□4□0	□3□0	1200	1100	1□□0	9□□0	
Built-in EtherCAT Port	Communications Standard	IEC 61158 Type12									
	EtherCAT Master Specifications	Class B (Feature Pack Motion Control compliant)									
	Physical Layer	100BASE-TX									
	Modulation	Baseband									
	Baud Rate	100 Mbps (100Base-TX)									
	Duplex mode	Auto									
	Topology	Line, daisy chain, and branching									
	Transmission Media	Twisted-pair cable of category 5 or higher (double-shielded straight cable with aluminum tape and braiding)									
	Maximum Transmission Distance between Nodes	100m									
	Maximum Number of Slaves	512		192				64			
	Range of node address	1-512		1-192							
	Maximum Process Data Size	Inputs: 11,472 bytes Outputs: 11,472 bytes (However, the maximum number of process data frames is 8.)			Inputs: 5,736 bytes Outputs: 5,736 bytes (However, the maximum number of process data frames is 4.)						
Maximum Process Data Size per Slave	Inputs: 1,434 bytes Outputs: 1,434 bytes										
Communications Cycle	<ul style="list-style-type: none"> Primary periodic task: 125 μs, 250 μs to 8 ms (in 250-μs increments) Priority-5 periodic task: 125 μs, 250 μs to 100 ms (in 250-μs increments) 			500/1,000/2,000/4,000 μs *13				1,000/2,000/4,000 μs			
Sync Jitter	1 μs max.										
Internal Clock	At ambient temperature of 55°C: -3.5 to +0.5 min error per month At ambient temperature of 25°C: -1.5 to +1.5 min error per month At ambient temperature of 0°C: -3 to +1 min error per month										

*13. The Maximum Communications Cycle of the NJ301 CPU Unit version 1.02 or earlier is 1,000/2,000/4,000 μs. The EtherCAT communications cycle of NJ501-4□□0 for robot control is 1 ms or more.

Function Specifications

Item		NX701-□□□□	NJ501-□□□□	NJ301-□□□□	NJ101-□□□□	
Tasks	Function	I/O refreshing and the user program are executed in units that are called tasks. Tasks are used to specify execution conditions and execution priority.				
		Periodically Executed Tasks	Maximum Number of Primary Periodic Tasks	1		
			Maximum Number of Periodic Tasks	4	3	
		Conditionally executed tasks *1	Maximum number of event tasks	32		
Execution conditions	When Activate Event Task instruction is executed or when condition expression for variable is met.					
Setup	System Service Monitoring Settings	---	The execution interval and the percentage of the total user program execution time are monitored for the system services (processes that are executed by the CPU Unit separate from task execution).			
Program- ming	POU (program organization units)	Programs	POUs that are assigned to tasks.			
		Function Blocks	POUs that are used to create objects with specific conditions.			
		Functions	POUs that are used to create an object that determine unique outputs for the inputs, such as for data processing.			
	Programming Languages	Types	Ladder diagrams *2 and structured text (ST)			
	Namespaces *3		A concept that is used to group identifiers for POU definitions.			
	Variables	External Access of Variables	Network Variables	The function which allows access from the HMI, host computers, or other Controllers		
	Data Types	Data Types	Boolean	BOOL		
			Bit Strings	BYTE, WORD, DWORD, LWORD		
			Integers	INT, SINT, DINT, LINT, UINT, USINT, UDINT, ULINT		
			Real Numbers	REAL, LREAL		
			Durations	TIME		
			Dates	DATE		
			Times of Day	TIME_OF_DAY		
			Date and Time	DATE_AND_TIME		
		Text Strings	STRING			
		Derivative Data Types	Structures, unions, enumerations			
		Structures	Function	A derivative data type that groups together data with different variable types.		
			Maximum Number of Members	2048		
			Nesting Maximum Levels	8		
	Member Data Types		Basic data types, structures, unions, enumerations, array variables			
Unions	Specifying Member Offsets	You can use member offsets to place structure members at any memory locations.*3				
	Function	A derivative data type that groups together data with different variable types.				
	Maximum Number of Members	4				
Enumerations	Member Data Types	BOOL, BYTE, WORD, DWORD, LWORD				
	Function	A derivative data type that uses text strings called enumerators to express variable values.				
Data Type Attributes	Array Specifications	Function	An array is a group of elements with the same data type. You specify the number (subscript) of the element from the first element to specify the element.			
		Maximum Number of Dimensions	3			
		Maximum Number of Elements	65535			
		Array Specifications for FB Instances	Supported.			
	Range Specifications	You can specify a range for a data type in advance. The data type can take only values that are in the specified range.				
Libraries	User libraries					

*1. Supported only by the CPU Units with unit version 1.03 or later.

*2. Inline ST is supported. (Inline ST is ST that is written as an element in a ladder diagram.)

*3. Supported only by the CPU Units with unit version 1.01 or later.

Item		NX701-□□□□	NJ501-□□□□	NJ301-□□□□	NJ101-□□□□	
Motion Control	Control Modes		position control, velocity control, torque control			
	Axis Types		Servo axes, virtual servo axes, encoder axes, and virtual encoder axes			
	Positions that can be managed		Command positions and actual positions			
	Single-axis	Single-axis Position Control	Absolute Positioning	Positioning is performed for a target position that is specified with an absolute value.		
			Relative Positioning	Positioning is performed for a specified travel distance from the command current position.		
			Interrupt Feeding	Positioning is performed for a specified travel distance from the position where an interrupt input was received from an external input.		
			Cyclic synchronous absolute positioning *1	The function which outputs command positions in every control period in the position control mode.		
		Single-axis Velocity Control	Velocity Control	Velocity control is performed in Position Control Mode.		
			Cyclic Synchronous Velocity Control	A velocity command is output each control period in Velocity Control Mode.		
		Single-axis Torque Control	Torque Control	The torque of the motor is controlled.		
		Single-axis Synchronized Control	Starting Cam Operation	A cam motion is performed using the specified cam table.		
			Ending Cam Operation	The cam motion for the axis that is specified with the input parameter is ended.		
			Starting Gear Operation	A gear motion with the specified gear ratio is performed between a master axis and slave axis.		
			Positioning Gear Operation	A gear motion with the specified gear ratio and sync position is performed between a master axis and slave axis.		
			Ending Gear Operation	The specified gear motion or positioning gear motion is ended.		
			Synchronous Positioning	Positioning is performed in sync with a specified master axis.		
			Master Axis Phase Shift	The phase of a master axis in synchronized control is shifted.		
		Single-axis Manual Operation	Combining Axes	The command positions of two axes are added or subtracted and the result is output as the command position.		
	Powering the Servo		The Servo in the Servo Drive is turned ON to enable axis motion.			
	Single-axis	Single-axis Manual Operation	Jogging	An axis is jogged at a specified target velocity.		
			Auxiliary Functions for Single-axis Control	Resetting Axis Errors	Axes errors are cleared.	
		Homing		A motor is operated and the limit signals, home proximity signal, and home signal are used to define home.		
		Homing with parameter *1		Specifying the parameter, a motor is operated and the limit signals, home proximity signal, and home signal are used to define home.		
		High-speed Homing		Positioning is performed for an absolute target position of 0 to return to home.		
		Stopping		An axis is decelerated to a stop at the specified rate.		
		Immediately Stopping		An axis is stopped immediately.		
		Setting Override Factors		The target velocity of an axis can be changed.		
		Changing the Current Position		The command current position or actual current position of an axis can be changed to any position.		
		Enabling External Latches		The position of an axis is recorded when a trigger occurs.		
		Disabling External Latches		The current latch is disabled.		
Zone Monitoring		You can monitor the command position or actual position of an axis to see when it is within a specified range (zone).				
Enabling digital cam switches *4		You can turn a digital output ON and OFF according to the position of an axis.				
Monitoring Axis Following Error		You can monitor whether the difference between the command positions or actual positions of two specified axes exceeds a threshold value.				
Resetting the Following Error		The error between the command current position and actual current position is set to 0.				
Torque Limit	The torque control function of the Servo Drive can be enabled or disabled and the torque limits can be set to control the output torque.					
Command position compensation *5	The function which compensate the position for the axis in operation.					
Start velocity *6	You can set the initial velocity when axis motion starts.					

*1. Supported only by the CPU Units with unit version 1.03 or later.

*4. Supported only by the CPU Units with unit version 1.06 or later.

*5. Supported only by the CPU Units with unit version 1.10 or later.

*6. Supported only by the CPU Units with unit version 1.05 or later.

Item		NX701-□□□□	NJ501-□□□□	NJ301-□□□□	NJ101-□□□□		
Motion Control	Axes Groups	Multi-axes Coordinated Control	Absolute Linear Interpolation	Linear interpolation is performed to a specified absolute position.			
			Relative Linear Interpolation	Linear interpolation is performed to a specified relative position.			
			Circular 2D Interpolation	Circular interpolation is performed for two axes.			
			Axes Group Cyclic Synchronous Absolute Positioning	A positioning command is output each control period in Position Control Mode.*3			
		Auxiliary Functions for Multi-axes Coordinated Control	Resetting Axes Group Errors	Axes group errors and axis errors are cleared.			
			Enabling Axes Groups	Motion of an axes group is enabled.			
			Disabling Axes Groups	Motion of an axes group is disabled.			
			Stopping Axes Groups	All axes in interpolated motion are decelerated to a stop.			
			Immediately Stopping Axes Groups	All axes in interpolated motion are stopped immediately.			
			Setting Axes Group Override Factors	The blended target velocity is changed during interpolated motion.			
			Reading Axes Group Positions	The command current positions and actual current positions of an axes group can be read.*3			
		Changing the Axes in an Axes Group	The Composition Axes parameter in the axes group parameters can be overwritten temporarily.*3				
		Common Items	Cams	Setting Cam Table Properties	The end point index of the cam table that is specified in the input parameter is changed.		
				Saving Cam Tables	The cam table that is specified with the input parameter is saved in non-volatile memory in the CPU Unit.		
	Generating cam tables *7			The cam table that is specified with the input parameter is generated from the cam property and cam node.			
	Parameters		Writing MC Settings	Some of the axis parameters or axes group parameters are overwritten temporarily.			
			Changing axis parameters *7	You can access and change the axis parameters from the user program.			
	Auxiliary Functions	Count Modes		You can select either Linear Mode (finite length) or Rotary Mode (infinite length).			
		Unit Conversions		You can set the display unit for each axis according to the machine.			
		Acceleration/ Deceleration Control	Automatic Acceleration/ Deceleration Control	Jerk is set for the acceleration/deceleration curve for an axis motion or axes group motion.			
			Changing the Acceleration and Deceleration Rates	You can change the acceleration or deceleration rate even during acceleration or deceleration.			
		In-position Check		You can set an in-position range and in-position check time to confirm when positioning is completed.			
		Stop Method		You can set the stop method to the immediate stop input signal or limit input signal.			
		Re-execution of Motion Control Instructions		You can change the input variables for a motion control instruction during execution and execute the instruction again to change the target values during operation.			
		Multi-execution of Motion Control Instructions (Buffer Mode)		You can specify when to start execution and how to connect the velocities between operations when another motion control instruction is executed during operation.			
		Continuous Axes Group Motions (Transition Mode)		You can specify the Transition Mode for multi-execution of instructions for axes group operation.			
		Monitoring Functions	Software Limits		Software limits are set for each axis.		
Following Error			The error between the command current value and the actual current value is monitored for an axis.				
Velocity, Acceleration Rate, Deceleration Rate, Torque, Interpolation Velocity, Interpolation Acceleration Rate, And Interpolation Deceleration Rate			You can set and monitor warning values for each axis and each axes group.				
Absolute Encoder Support		You can use an OMRON G5-Series or 1S-Series Servomotor with an Absolute Encoder to eliminate the need to perform homing at startup.					
Input signal logic inversion *6		You can inverse the logic of immediate stop input signal, positive limit input signal, negative limit input signal, or home proximity input signal.					
External Interface Signals		The Servo Drive input signals listed on the right are used. Home signal, home proximity signal, positive limit signal, negative limit signal, immediate stop signal, and interrupt input signal					

*3. Supported only by the CPU Units with unit version 1.01 or later.

*6. Supported only by the CPU Units with unit version 1.05 or later.

*7. Supported only by the CPU Units with unit version 1.08 or later.

Item				NX701-□□□□	NJ501-□□□□	NJ301-□□□□	NJ101-□□□□	
Unit (I/O) Management	EtherCAT Slaves	Maximum Number of Slaves		512	192		64	
	CJ-Series Units	Maximum number of Units		---	40			
		Basic I/O Units	Load Short-circuit Protection and I/O Disconnection Detection		Alarm information for Basic I/O Units is read.			
Communications	Peripheral USB Port			A port for communications with various kinds of Support Software running on a personal computer.				
	Built-in EtherNet/IP port Internal Port	Communications protocol		TCP/IP, UDP/IP				
		CIP Communications Service	Tag Data Links	Programless cyclic data exchange is performed with the devices on the EtherNet/IP network.				
			Message Communications	CIP commands are sent to or received from the devices on the EtherNet/IP network.				
		TCP/IP functions	CIDR	The function which performs IP address allocations without using a class (class A to C) of IP address.				
			IP Forwarding *5	The function which forward IP packets between interfaces.	---			
		TCP/IP Applications	Socket Services		Data is sent to and received from any node on Ethernet using the UDP or TCP protocol. Socket communications instructions are used.			
			FTP client *7		File can be read from or written to computers at other Ethernet nodes from the CPU Unit. FTP client communications instructions are used.			
			FTP Server		Files can be read from or written to the SD Memory Card in the CPU Unit from computers at other Ethernet nodes.			
			Automatic Clock Adjustment		Clock information is read from the NTP server at the specified time or at a specified interval after the power supply to the CPU Unit is turned ON. The internal clock time in the CPU Unit is updated with the read time.			
		EtherCAT Port	Supported Services	Process Data Communications		Control information is exchanged in cyclic communications between the EtherCAT master and slaves.		
	SDO Communications			A communications method to exchange control information in noncyclic event communications between EtherCAT master and slaves. This communications method is defined by CoE.				
	Network Scanning			Information is read from connected slave devices and the slave configuration is automatically generated.				
	DC (Distributed Clock)			Time is synchronized by sharing the EtherCAT system time among all EtherCAT devices (including the master).				
	Packet Monitoring *8			The frames that are sent by the master and the frames that are received by the master can be saved. The data that is saved can be viewed with WireShark or other applications.				
	Enable/disable Settings for Slaves			The slaves can be enabled or disabled as communications targets.				
	Disconnecting/Connecting Slaves			Temporarily disconnects a slave from the EtherCAT network for maintenance, such as for replacement of the slave, and then connects the slave again.				
	Supported Application Protocol		CoE		SDO messages of the CAN application can be sent to slaves via EtherCAT.			
	Communications Instructions			The following instructions are supported. CIP communications instructions, socket communications instructions, SDO message instructions, no-protocol communications instructions *9, FTP client instructions, and Modbus RTU protocol instructions *9	The following instructions are supported. CIP communications instructions, socket communications instructions, SDO message instructions, no-protocol communications instructions, protocol macro instructions, and FTP client instructions *7, and Modbus RTU protocol instructions *9			
	Operation Management	RUN Output Contacts			The output on the Power Supply Unit turns ON in RUN mode.			
System Management	Event Logs	Function		Events are recorded in the logs.				
		Maximum number of events	System event log		2,048	1,024	512	
			Access event log		1,024		512	
			User-defined event log		1,024		512	

*5. Supported only by the CPU Units with unit version 1.10 or later.
 *6. Supported only by the CPU Units with unit version 1.05 or later.
 *7. Supported only by the CPU Units with unit version 1.08 or later.
 *8. For NJ301, Supported only by the CPU Units with unit version 1.10 or later.
 *9. Supported only by the CPU Units with unit version 1.11 or later.

Item		NX701-□□□□	NJ501-□□□□	NJ301-□□□□	NJ101-□□□□	
Debugging	Online Editing	Single	Programs, function blocks, functions, and global variables can be changed online. Different operators can change different POU's across a network.			
	Forced Refreshing		The user can force specific variables to TRUE or FALSE.			
	Maximum Number of Forced Variables	Device Variables for EtherCAT Slaves	64			
		Device Variables for CJ-series Units and Variables with AT Specifications	---	64		
	MC Test Run *10		Motor operation and wiring can be checked from the Sysmac Studio.			
	Synchronizing		The project file in the Sysmac Studio and the data in the CPU Unit can be made the same when online.			
	Differentiation monitoring *1		Rising/falling edge of contacts can be monitored.			
		Maximum number of contacts *1	8			
	Data Tracing	Types	Single Triggered Trace	When the trigger condition is met, the specified number of samples are taken and then tracing stops automatically.		
			Continuous Trace	Data tracing is executed continuously and the trace data is collected by the Sysmac Studio.		
		Maximum Number of Simultaneous Data Trace		4	4 *11	2
		Maximum Number of Records		10,000		
		Sampling	Maximum Number of Sampled Variables	192 variables		48 variables
		Timing of Sampling		Sampling is performed for the specified task period, at the specified time, or when a sampling instruction is executed.		
Triggered Traces		Trigger conditions are set to record data before and after an event.				
	Trigger Conditions	When BOOL variable changes to TRUE or FALSE Comparison of non-BOOL variable with a constant Comparison Method: Equals (=), Greater than (>), Greater than or equals (≥), Less Than (<), Less than or equals (≤), Not equal (≠)				
		Delay	Trigger position setting: A slider is used to set the percentage of sampling before and after the trigger condition is met.			
Simulation		The operation of the CPU Unit is emulated in the Sysmac Studio.				
Reliability Functions	Self-diagnosis	Controller Errors	Levels	Major fault, partial fault, minor fault, observation, and information		
		User-defined errors		User-defined errors are registered in advance and then records are created by executing instructions.		
		Levels		8 levels		
Security	Protecting Software Assets and Preventing Operating Mistakes	CPU Unit Names and Serial IDs		When going online to a CPU Unit from the Sysmac Studio, the CPU Unit name in the project is compared to the name of the CPU Unit being connected to.		
		Protection	User Program Transfer with No Restoration Information	You can prevent reading data in the CPU Unit from the Sysmac Studio.		
			CPU Unit Write Protection	You can prevent writing data to the CPU Unit from the Sysmac Studio or SD Memory Card.		
			Overall Project File Protection	You can use passwords to protect .smc files from unauthorized opening on the Sysmac Studio.		
			Data Protection	You can use passwords to protect POU's on the Sysmac Studio.*3		
		Verification of Operation Authority		Online operations can be restricted by operation rights to prevent damage to equipment or injuries that may be caused by operating mistakes.		
	Number of Groups	5	5 *12	5		
	Verification of User Program Execution ID	The user program cannot be executed without entering a user program execution ID from the Sysmac Studio for the specific hardware (CPU Unit).				
SD Memory Card Functions	Storage Type		SD Memory Card, SDHC Memory Card			
	Application	Automatic transfer from SD Memory Card *1	The data in the autoloader folder on an SD Memory Card is automatically loaded when the power supply to the Controller is turned ON.			
		Transfer program from SD Memory Card *9	The user program on an SD Memory Card is loaded when the user changes system-defined variable to TRUE.			
		SD Memory Card Operation Instructions	You can access SD Memory Cards from instructions in the user program.			
		File Operations from the Sysmac Studio	You can perform file operations for Controller files in the SD Memory Card and read/write standard document files on the computer.			
	SD Memory Card Life Expiration Detection	Notification of the expiration of the life of the SD Memory Card is provided in a systemdefined variable and event log.				

*1. Supported only by the CPU Units with unit version 1.03 or later.

*3. Supported only by the CPU Units with unit version 1.01 or later.

*9. Supported only by the CPU Units with unit version 1.11 or later.

*10. Cannot be used with the NJ101-9000.

*11. Maximum Number of Simultaneous Data Trace of the NJ501-1□20 CPU Unit with unit version 1.08 or later is 2.

*12. When the NJ501 CPU Units with unit version 1.00 is used, this value becomes two.

Item				NX701-□□□□	NJ501-□□□□	NJ301-□□□□	NJ101-□□□□
Backup functions *1	SD Memory Card backup functions	Operation	Using front switch	You can use front switch to backup, compare, or restore data.			
			Using system-defined variables	You can use system-defined variables to backup, compare, or restore data. *13			
			Memory Card Operations Dialog Box on Sysmac Studio	Backup and verification operations can be performed from the SD Memory Card Operations Dialog Box on the Sysmac Studio.			
			Using instruction *7	Backup operation can be performed by using instruction.			
	Protection	Prohibiting backing up data to the SD Memory Card	Prohibit SD Memory Card backup functions.				
Sysmac Studio Controller backup functions			Backup, restore, and verification operations for Units can be performed from the Sysmac Studio.				

*1. Supported only by the CPU Units with unit version 1.03 or later.

*7. Supported only by the CPU Units with unit version 1.08 or later.

*13. Restore is supported with unit version 1.14 or later.

Function Specifications of DB Connection Function

Besides functions of the NJ501-□□□□ or NJ101-□□□□, functions supported by the NJ501-□□□20 or NJ101-□□□20 are as follows.

Item	Description	
	NJ501-1□□20	NJ101-□□□20
Supported port	Built-in EtherNet/IP port	
Supported DB	Microsoft Corporation: SQL Server 2008/2008 R2/2012/2014 *1 Oracle Corporation: Oracle Database 10g /11g /12c *1 MySQL Community Edition 5.1/5.5/5.6 *2 International Business Machines Corporation (IBM): DB2 for Linux, UNIX and Windows 9.5/9.7/10.1/10.5 Firebird Foundation Incorporated: Firebird 2.1/2.5 The PostgreSQL Global Development Group: PostgreSQL 9.2/9.3/9.4 *1	
Number of DB Connections (Number of databases that can be connected at the same time)	3 connections max. *3	
Instruction	Supported operations	The following operations can be performed by executing DB Connection Instructions in the NJ-series CPU Units. Inserting records (INSERT), Updating records (UPDATE), Retrieving records (SELECT), and Deleting records (DELETE)
	Number of columns in an INSERT operation	SQL Server: 1,024 columns max. Oracle: 1,000 columns max.
	Number of columns in an UPDATE operation	SQL Server: 1,024 columns max. Oracle: 1,000 columns max.
	Number of columns in a SELECT operation	SQL Server: 1,024 columns max. Oracle: 1,000 columns max.
	Number of records in the output of a SELECT operation	65,535 elements max., 4 MB max.
Run mode of the DB Connection Service	Operation Mode or Test Mode • Operation Mode: When each instruction is executed, the service actually accesses the DB. • Test Mode: When each instruction is executed, the service ends the instruction normally without accessing the DB actually.	
Spool function	Used to store SQL statements when an error occurred and resend the statements when the communications are recovered from the error.	
	Spool capacity	1 MB *4 192 KB *4
Operation Log function	The following three types of logs can be recorded. • Execution Log: Log for tracing the executions of the DB Connection Service. • Debug Log: Detailed log for SQL statement executions of the DB Connection Service. • SQL Execution Failure Log: Log for execution failures of SQL statements in the DB.	
DB Connection Service shutdown function	Used to shut down the DB Connection Service after automatically saving the Operation Log files into the SD Memory Card.	

*1. SQL Server 2014, Oracle Database 12c and PostgreSQL 9.2/9.3/9.4 are supported by DBCon version 1.02 or higher.

*2. The supported storage engines of the DB are InnoDB and MyISAM.

*3. When two or more DB Connections are established, the operation cannot be guaranteed if you set different database types for the connections.

*4. Refer to "NJ-series Database Connection CPU Units User's Manual(W527)" for the information.

NJ/NX-Series

Functions Supported by NJ501-1340

Besides functions of the NJ501-1300, functions supported by the NJ501-1340 are as follows.

Item	Description
Supported port	Built-in EtherNet/IP port
Supported standard *1	The Unit conforms to the following SEMI standards: E37-0303, E37.1-0702, E5-0707, and E30-0307
Fundamental GEM requirement	State Model, Equipment Processing State, Host-initiated S1, F13/F14 Scenario, Event Notification, On-Line Identification, Error Message, Control (Operator Initiated), Documentation
Additional GEM capability	Establish Communications, Dynamic Event Report Configuration, Variable Data Collection, Trace Data Collection, Status Data Collection, Alarm Management, Remote Control, Equipment Constant, Process Recipe Management *1, Material Movement, Equipment Terminal Service, Clock, Limit Monitoring, Spooling *2, Control (Host Initiated)
User-defined message	You can create non-GEM compliant communications messages and have host communications.
GEM specific instruction	The Unit supports 29 instructions to perform the following: <ul style="list-style-type: none"> • Changing the GEM Service status. • Setting HSMS communications. • Reporting events and reporting alarms. • Acknowledging host commands and enhanced remote commands. • Changing equipment constants. • Uploading and downloading process programs. • Sending and acknowledging equipment terminal messages. • Requesting to change time. • Sending user-defined messages. • Getting SECS communications log.
GEM Service log *2	Can record the following information. <ul style="list-style-type: none"> • HSMS communications log: Keeps log of HSMS communications operations. • SECS message log: Keeps log of SECS-II communications messages. • Execution log: Keeps log of executions of GEM instructions.
Shutting down the GEM Service	Saves the pool data and GEM Service log records into an SD Memory Card and ends the GEM Service.

*1. E42 recipes, large process programs, and E139 recipes are not supported.

*2. The capability is not available when no SD Memory Card is mounted.

Conformance to Fundamental GEM Requirements and Additional Capabilities

Fundamental GEM requirements	GEM-compliant	Additional capabilities	GEM-compliant
State Model	Yes	Establish Communications	Yes
Equipment Processing State		Dynamic Event Report Configuration	
Host-initiated S1, F13/F14 Scenario		Variable Data Collection	
Event Notification		Trace Data Collection	
On-Line Identification		Status Data Collection	
Error Message		Alarm Management	
Control (Operator Initiated)		Remote Control	
Documentation		Equipment Constant	
		Process Recipe Management	Process program: Yes E42 recipes: No E139 recipes: No
		Material Movement	Yes
		Equipment Terminal Service	
		Clock	
		Limit Monitoring	
		Spooling	
		Control (Host Initiated)	

Functions Supported by NJ501-4□□□

Besides functions of the NJ501-1□□□, functions supported by the NJ501-4□□□ are as follows.

Item				NJ501-				
				4500	4400	4300	4310	4320
Robot control functions	Axes groups	Multi-axes coordinated control	Conveyer tracking	The robot is moved in synchronization with the conveyor during the conveyor tracking operation.				
		Auxiliary functions for multi-axes coordinated control	Kinematics Setting	Set parameters for robot operation, such as arm length of Delta3 robot.				
	Auxiliary functions	Monitoring functions	Work space function	Set the coordinate values for workspace check and check the workspace during operation.				

Version Information

Unit Versions

Units	Models	Unit Version
NX701 CPU Units	NX701-□□□□	From unit version 1.10 to 1.14
NJ501 CPU Units	NJ501-□□□□	From unit version 1.00 to 1.15
NJ301 CPU Units	NJ301-□□□□	From unit version 1.01 to 1.14
NJ101 CPU Units	NJ101-□□□□	From unit version 1.11 to 1.14
NJ-series Database Connection CPU Units	NJ501-□□20	Unit version 1.05 From unit version 1.07 to 1.15
	NJ101-□□20	From unit version 1.11 to 1.14
NJ-series SECS/GEM CPU Unit	NJ501-1340	From unit version 1.09 to 1.15
NJ-series NJ Robotics CPU Units	NJ501-4□□0	From unit version 1.02 to 1.15

Unit Versions and Programming Devices (NX701 CPU Units / NJ-series CPU Units)

The following tables show the relationship between unit versions and Sysmac Studio versions.

Unit Versions and Programming Devices

Unit Version of CPU Unit	Corresponding version of Sysmac Studio
1.15	1.19
1.14	1.18
1.13	1.17
1.12	1.16
1.11	1.15
1.10 *1*2	1.14
	1.13
	1.12
1.09 *3	1.11
	1.10
1.08	1.09
1.07	1.08
1.06	1.07
1.05 *4	1.06
1.04	1.05
1.03	1.04
1.02	1.03
1.01	1.02
1.00 *5	1.01
	1.00

*1. The NJ101-1020 or NJ101-9020 can be used with Sysmac Studio version 1.14 or higher.

*2. The NX701-□□□□/NJ101-□□□□ CPU Unit can be used with Sysmac Studio version 1.13 or higher.

*3. The NJ501-1340 CPU Unit can be used with Sysmac Studio version 1.11 or higher.

*4. The NJ501-1□□20 CPU Unit can be used with Sysmac Studio version 1.07 or higher.

*5. There is no NJ301-□□□□ CPU Unit with unit version 1.00. Therefore, you cannot use an NJ301-□□□□ CPU Unit with Sysmac Studio version 1.01 or lower.

Note: 1. If you use a lower version of the Sysmac Studio, you can use only the functions of the unit version of the CPU Unit that corresponds to the Sysmac Studio version.

If you use a CPU Unit with an earlier version, select the unit version of the connected CPU Unit or an earlier unit version in the Select Device Area of the Project Properties Dialog Box on the Sysmac Studio. You can use only the functions that are supported by the unit version of the connected CPU Unit.

2. The license number for a robot is required to use this CPU Unit. Contact your OMRON representative for details.

NJ/NX-Series

Unit Versions, DBCon Versions and Programming Devices (NJ-series Database Connection CPU Units)

The following table gives the relationship between unit versions of CPU Units and the corresponding Sysmac Studio versions.

Unit version of CPU Unit	DBCon Version	Corresponding version of Sysmac Studio
1.15	1.02	1.19
1.14		1.18
1.13		1.17
1.12		1.16
1.11		1.15
1.10 *	1.01	1.14
1.09		1.13
		1.12
1.08	1.00	1.11
1.07		1.10
1.05	1.00	1.09
		1.08
		1.07
		1.06

Note: If you use a lower version of the Sysmac Studio, you can use only the functions of the unit version of the CPU Unit that corresponds to the Sysmac Studio version.

If you use a CPU Unit with an earlier version, select the unit version of the connected CPU Unit or an earlier unit version in the Select Device Area of the Project Properties Dialog Box on the Sysmac Studio. You can use only the functions that are supported by the unit version of the connected CPU Unit.

* For NJ101-□□□20, Supported only by the Sysmac Studio version 1.14 or higher.

Unit Versions, Robot Versions and Programming Devices (NJ-series NJ Robotics CPU Units)

The following table gives the relationship between unit versions of CPU Units and the corresponding Sysmac Studio versions.

Unit version of CPU Unit	Robot version of CPU Unit	Corresponding version of Sysmac Studio
1.15	1.04	1.19
1.14		1.18
1.13	1.03	1.17
1.12		1.16
1.11		1.15
1.10	1.02	1.14
1.09	1.02	1.13
1.08	1.02	1.12
	1.01	1.11
1.07	1.00	1.10
1.06		1.08
1.05		1.07
1.04		1.06
1.03		1.05
1.02		1.04
		1.04

Note: If you use a lower version of the Sysmac Studio, you can use only the functions of the unit version of the CPU Unit that corresponds to the Sysmac Studio version.

If you use a CPU Unit with an earlier version, select the unit version of the connected CPU Unit or an earlier unit version in the Select Device Area of the Project Properties Dialog Box on the Sysmac Studio. You can use only the functions that are supported by the unit version of the connected CPU Unit.

Relationship between Hardware Revisions of CPU Units and Sysmac Studio Versions

The following table shows how the hardware revisions of the NJ-series CPU Units correspond to Sysmac Studio versions. Use the corresponding version of Sysmac Studio or higher if you execute the Simulator in Execution Time Estimation Mode. You cannot select the relevant hardware revision if you use a lower version of the Sysmac Studio.

Model number	Hardware revision of CPU Unit	Corresponding version of Sysmac Studio
NJ501-□□□□	A	Ver.1.14 or higher

Functions That Were Added or Changed for Each Unit Version and Sysmac Studio version

Additions and Changes to Functional Specifications

The following table gives the unit version of the CPU Units and the Sysmac Studio version for each addition or change to the functional specifications.

Function				Addition/ change	Unit version	Sysmac Studio version
Tasks	Function	Conditionally executed tasks		Addition	1.03	1.04
Programming	Namespaces			Addition	1.01	1.02
	Data types	Structure data types	Specifying member offsets	Addition Change	1.01	1.02 1.03
	Libraries			Addition	1.01	1.02
Motion control	Single axes	Single-axis position control	Cyclic synchronous absolute positioning	Addition	1.03	1.04
			Homings with specified parameters	Addition	1.03	1.04
		Auxiliary function for single-axis control	Enabling digital cam switches	Addition	1.06	1.07
			Command position compensation	Addition	1.10	1.12
			Start velocity	Addition	1.05	1.06
	Axes groups	Multi-axes coordinated control	Axes group cyclic synchronous absolute positioning	Addition	1.01	1.02
			Reading axes group positions	Addition	1.01	1.02
		Auxiliary functions for multi-axes coordinated control	Changing the axes in a group	Addition	1.01	1.02
	Common items	Cams	Generating cam tables	Addition	1.08	1.09
		Parameters	Changing axis parameters	Addition	1.08	1.09
	Auxiliary functions	Input signal logic inversion		Addition	1.05	1.06
Unit (I/O) management	NX Units			Addition	1.05	1.06
Communications	EtherNet/IP port	TCP/IP applications	FTP client	Addition	1.08	1.09
	EtherCAT port	Packet monitoring * (NJ301-□□□□)		Addition	1.10	1.12
	Communications instructions			Change	1.08 1.11	1.09 1.15
Debugging function	Differential monitoring			Addition	1.03	1.04
Reliability functions	Self diagnosis	Controller errors	Changing levels	Addition	1.03	1.04
Security	Asset protection and preventing incorrect operation	Protection	Data protection	Addition	1.01	1.02
		Operation authority verification	Number of groups	Change	1.01	1.02
SD Memory Cards	Application	Automatic transfer from SD Memory Card		Addition	1.03	1.04
		Transfer program from SD Memory Card		Addition	1.11	1.15
Backing up data	SD Memory Card back-ups	Operating methods	CPU Unit front-panel DIP switch	Addition	1.03	1.04
			Specification with system-defined variables	Addition	1.03	1.04
			SD Memory Card Window in Sysmac Studio	Addition	1.03	1.04
			Special instruction	Addition	1.08	1.09
	Protection	Disabling backups to SD Memory Cards	Addition	1.03	1.04	
Sysmac Studio Controller backups			Addition	1.03	1.04	

* This addition applies only to an NJ301-□□□□ CPU Unit. The NJ501-□□□□ and NJ101-□□□□ CPU Units support packet monitoring with all versions.

Performance Improvements for Unit Version Upgrades

This section introduces the functions for which performance was improved for each unit version of NJ-series CPU Unit and for each Sysmac Studio version.

Function				Performance value	Unit version	Sysmac Studio version
Programming	Program capacity	Quantities	Number of POU instances (NJ501-□□□□)	9,000	---	1.06 or higher
				6,000	---	1.05 or lower
			Number of POU instances (NJ301-□□□□)	3,000	1.04 or later	1.05 or higher
				1,500	1.03 or earlier	1.04 or lower
				2,400		1.05 or higher
	Memory capacity for variables	Variables with a Retain attribute	Number of variables ^{*1} (NJ301-□□□□)	1,500	1.04 or later	1.04 or lower
				5,000	1.05 or higher	
			2,500	1.03 or earlier	---	
Motion Control	Number of controlled axes	Maximum number of controlled axes ^{*2*3*4} (NJ301-□□□□)	15 axes	1.06 or later	1.07 or higher	
			8 axes (NJ301-1200) 4 axes (NJ301-1100)	Other than the above combination		
		Maximum number of axes for single-axis control ^{*4*5} (NJ301-□□□□)	15 axes	1.06 or later	1.07 or higher	
			8 axes (NJ301-1200) 4 axes (NJ301-1100)	Other than the above combination		
Built-in EtherNet/IP port	CIP service: Tag data links (cyclic communications)	Packet interval	Can be set for each connection. 1 to 10,000 ms in 1-ms increments	1.03 or later	---	
			Can be set for each connection. 10 to 10,000 ms in 1-ms increments	1.02 or earlier	---	
		Permissible communications band	3,000 pps ^{*6} (including heartbeat)	1.03 or later	---	
			1,000 pps (including heartbeat)	1.02 or earlier	---	
	Number of TCP sockets		30	1.03 or later	---	
			16	1.02 or earlier	---	
	Built-in EtherCAT port	Communications cycle ^{*7} (NJ301-□□□□)		500, 1,000, 2,000, or 4,000 μs	1.03 or later	---
			1,000, 2,000, or 4,000 μs	1.02 or earlier	---	

*1. The performance improvement applies only to an NJ301-□□□□ CPU Unit. The maximum number of variables with a Retain attributes for the NJ501-□□□□ is 10,000.

*2. This is the total for all axis types.

*3. The performance improvement applies only to an NJ301-□□□□ CPU Unit. The maximum numbers of controlled axes for the NJ501-□□□□ are as follows:

NJ501-1500: 64 axes, NJ501-1400: 32 axes, and NJ501-1300: 16 axes

*4. There is no change in the maximum number of used real axes.

*5. The performance improvement applies only to an NJ301-□□□□ CPU Unit. The maximum numbers of axes for single-axis control for the NJ501-□□□□ are as follows:

NJ501-1500: 64 axes, NJ501-1400: 32 axes, and NJ501-1300: 16 axes

*6. Here, pps means "packets per second" and indicates the number of packets that can be processed in one second.

*7. The performance improvement applies only to an NJ301-□□□□ CPU Unit. You can use 500, 1,000, 2,000 or 4,000 μs communications cycle with an NJ501-□□□□ CPU Unit, and 1,000, 2,000 or 4,000 μs communications cycle with an NJ101-□□□□ CPU Unit.

Components and Functions

NX-series CPU Unit

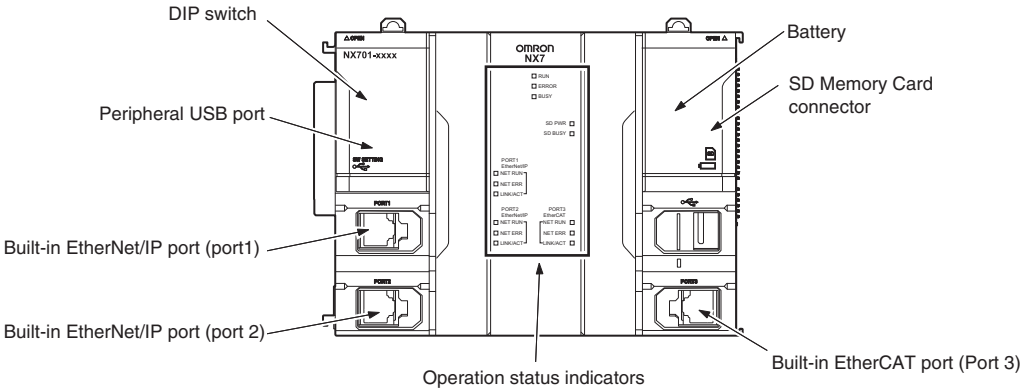

NJ-series CPU Unit

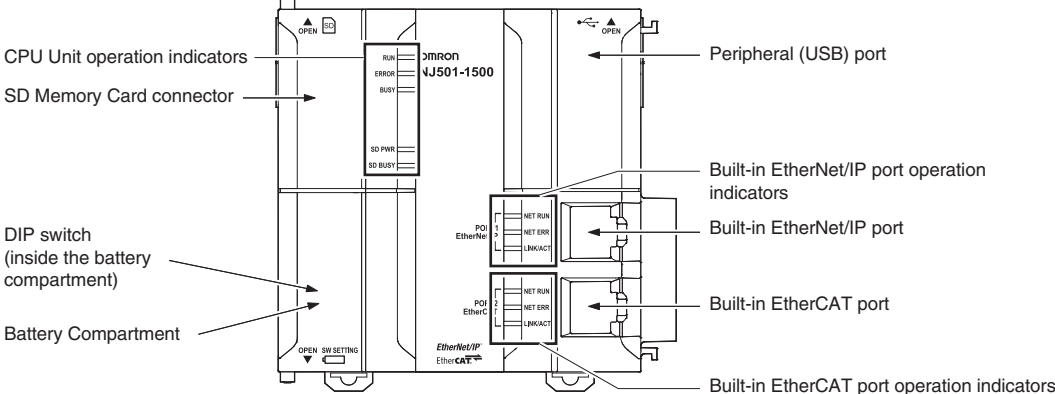

NJ/NX-Series

Dimensions

(Unit: mm)

NX701 CPU Units (NX701-□□□□)

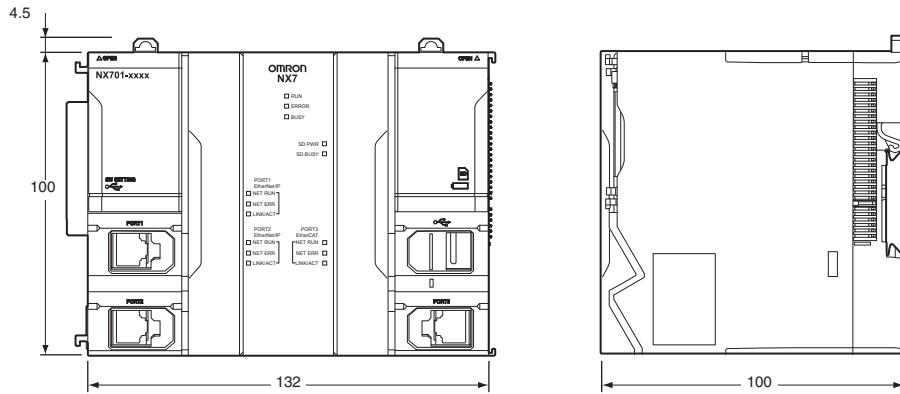

When a cable is connected (such as a communications cable)

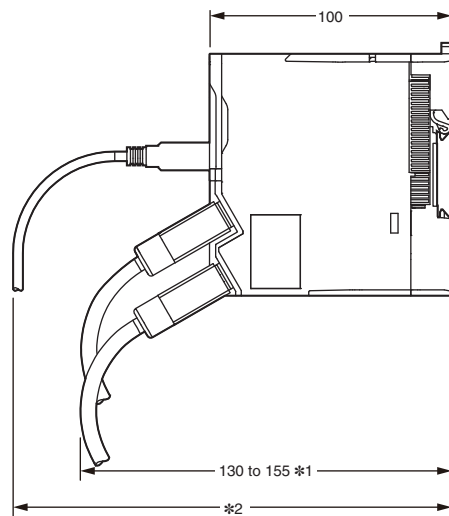

- *1. This is the dimension from the back of the Unit to the communications cables.
 130 mm: When an MPS588-C Connector is used.
 155 mm: When an XS6G-T421-1 Connector is used.
- *2. This dimension depends on the specifications of the commercially available USB cable. Check the specifications of the USB cable that is used.

NJ-series CPU Units

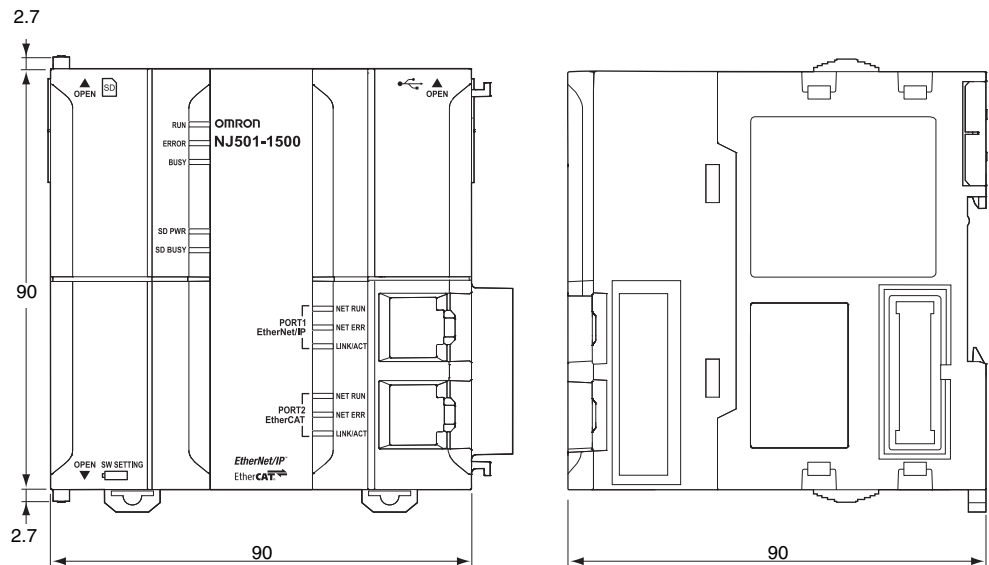

Related Manuals

Cat. No.	Model number	Manual	Application	Description
W513	NJ501-□□□□ NJ301-□□□□ NJ101-□□□□	NJ Series Startup Guide (CPU Unit)	Using the NJ-series CPU Unit for the first time	The startup procedures for using an NJ-series CPU Unit and the basic operating instructions for the Sysmac Studio are described with a simple sequence control example.
W514	NX701-□□□□ NX1P2-□□□□ NJ501-□□□□ NJ301-□□□□ NJ101-□□□□	NJ/NX-series Startup Guide (Motion Control)	Using the motion control function module of the NJ/NX-series for the first time	The startup procedures for setting axis parameters and performing simple one-axis positioning and two-axis linear interpolation with an NJ/NX-series CPU Unit and the operating instructions for the Sysmac Studio are described.
W535	NX701-□□□□	NX-series CPU Unit Hardware User's Manual	Learning the basic specifications of the NX701-series CPU Units, including introductory information, designing, installation, and maintenance. Mainly hardware information is provided.	An introduction to the entire NX701-series system is provided along with the following information on a Controller built with a CPU Unit. <ul style="list-style-type: none"> • Features and system configuration • Introduction • Part names and functions • General specifications • Installation and wiring • Maintenance and inspection Use this manual together with the <i>NJ/NX-series CPU Unit Software User's Manual</i> (Cat. No. W501).
W500	NJ501-□□□□ NJ301-□□□□ NJ101-□□□□	NJ-series CPU Unit Hardware User's Manual	Learning the basic specifications of the NJ-series CPU Units, including introductory information, designing, installation, and maintenance. Mainly hardware information is provided.	An introduction to the entire NJ-series system is provided along with the following information on a Controller built with a CPU Unit. <ul style="list-style-type: none"> • Features and system configuration • Introduction • Part names and functions • General specifications • Installation and wiring • Maintenance and inspection Use this manual together with the <i>NJ-series CPU Unit Software User's Manual</i> (Cat. No. W501).
W501	NX701-□□□□ NX1P2-□□□□ NJ501-□□□□ NJ301-□□□□ NJ101-□□□□	NJ/NX-series CPU Unit Software User's Manual	Learning how to program and set up an NJ/NX-series CPU Unit. Mainly software information is provided.	The following information is provided on a Controller built with an NJ/NX-series CPU Unit. <ul style="list-style-type: none"> • CPU Unit operation • CPU Unit features • Initial settings • Programming language specifications and programming with the IEC 61131-3 standard. Use this manual together with the <i>NJ-series CPU Unit Hardware User's Manual</i> (Cat. No. W500).
W507	NX701-□□□□ NX1P2-□□□□ NJ501-□□□□ NJ301-□□□□ NJ101-□□□□	NJ/NX-series CPU Unit Motion Control User's Manual	Learning about motion control settings and programming concepts	The settings and operation of the CPU Unit and programming concepts for motion control are described. Use this manual together with the <i>NJ-series CPU Unit Hardware User's Manual</i> (Cat. No. W500) and <i>NJ/NX-series CPU Unit Software User's Manual</i> (Cat. No. W501).
W505	NX701-□□□□ NX1P2-□□□□ NJ501-□□□□ NJ301-□□□□ NJ101-□□□□	NJ/NX-series CPU Unit Built-in EtherCAT Port User's Manual	Using the built-in EtherCAT port on an NJ/NX-series CPU Unit	Information on the built-in EtherCAT port is provided. This manual provides an introduction and provides information on the configuration, features, and setup. Use this manual together with the <i>NJ-series CPU Unit Hardware User's Manual</i> (Cat. No. W500) and <i>NJ/NX-series CPU Unit Software User's Manual</i> (Cat. No. W501).
W539	NJ501-4□□□	NJ-series Robotics CPU Units User's Manual	Using the robot control with NJ-series Controllers.	Describes the robot control. Use this manual together with the <i>NJ/NX-series CPU Unit Motion Control User's Manual</i> (Cat. No. W507) and the <i>NJ/NX-series Motion Control Instructions Reference Manual</i> (Cat. No. W508).
W527	NJ501-□□20 NJ101-□□20	NJ-series Database Connection CPU Units User's Manual	Learning about the functions and application procedures of the NJ-series DB Connection function.	Describes the functions and application procedures of the NJ-series DB Connection function.
W528	NJ501-1340	NJ-series SECS/GEM CPU Unit User's Manual	Learning about the SECS/GEM CPU Unit and how to use it.	Functional outline, GEM instructions, settings with the GEM Configurator and so on are provided.
W506	NX701-□□□□ NX1P2-□□□□ NJ501-□□□□ NJ301-□□□□ NJ101-□□□□	NJ/NX-series CPU Unit Built-in EtherNet/IP Port User's Manual	Using the built-in EtherNet/IP port on an NJ/NX-series CPU Unit	Information on the built-in EtherNet/IP port is provided. Information is provided on the basic setup, tag data links, FINS communications (non-disclosure), and other features. Use this manual together with the <i>NJ-series CPU Unit Hardware User's Manual</i> (Cat. No. W500) and <i>NJ/NX-series CPU Unit Software User's Manual</i> (Cat. No. W501).
W502	NX701-□□□□ NX1P2-□□□□ NJ501-□□□□ NJ301-□□□□ NJ101-□□□□	NJ/NX-series Instructions Reference Manual	Learning about the specifications of the instruction set that is provided by OMRON	The instructions in the instruction set (IEC 61131-3 specifications) are described. Use this manual together with the <i>NJ-series CPU Unit Hardware User's Manual</i> (Cat. No. W500) and <i>NJ/NX-series CPU Unit Software User's Manual</i> (Cat. No. W501).

NJ/NX-Series

Cat. No.	Model number	Manual	Application	Description
W508	NX701-□□□□ NX1P2-□□□□ NJ501-□□□□ NJ301-□□□□ NJ101-□□□□	NJ/NX-series Motion Control Instructions Reference Manual	Learning about the specifications of the motion control instructions that are provided by OMRON	The motion control instructions are described. Use this manual together with the <i>NJ-series CPU Unit Hardware User's Manual</i> (Cat. No. W500), <i>NJ/NX-series CPU Unit Software User's Manual</i> (Cat. No. W501) and <i>NJ/NX-series CPU Unit Motion Control User's Manual</i> (Cat. No. W507).
W503	NX701-□□□□ NX1P2-□□□□ NJ501-□□□□ NJ301-□□□□ NJ101-□□□□	NJ/NX-series Troubleshooting Manual	Learning about the errors that may be detected in an NJ/NX-series Controller.	Concepts on managing errors that may be detected in an NJ/NX-series Controller and information on individual errors are described. Use this manual together with the <i>NJ-series CPU Unit Hardware User's Manual</i> (Cat. No. W500) and <i>NJ/NX-series CPU Unit Software User's Manual</i> (Cat. No. W501).
W504	SYSMAC-SE2□□□	Sysmac Studio Version 1 Operation Manual	Learning about the operating procedures and functions of the Sysmac Studio.	Describes the operating procedures of the Sysmac Studio.
W490 W498 W491 Z317 W492 W494 W497 W495 W493	CJ1W-□□□□*	CJ-series Special Unit Manuals for NJ-series CPU Unit	Learning how to connect CJ-series Units	The methods and precautions for using CJ-series Units with an NJ-series CPU Unit are described, including access methods and programming interfaces. Manuals are available for the following Units. Analog I/O Units, Insulated-type Analog I/O Units, Temperature Control Units, ID Sensor Units, High-speed Counter Units, and DeviceNet Units, EtherNet/IP Units, CompoNet Master Units Use this manual together with the <i>NJ-series CPU Unit Hardware User's Manual</i> (Cat. No. W500) and <i>NJ/NX-series CPU Unit Software User's Manual</i> (Cat. No. W501).
Y128	SYSMAC-SE20□□ SYSMAC-RA401L NJ501-4□□□ R88D-KN□-ECT FH-1□□□ FH-3□□□	Vision & Robot Integrated Simulation Startup Guide	Learning about the operating procedures of Vision & Robot integrated simulation.	Describes the operating procedures of Vision & Robot integrated simulation.
Y213		Vision & Robot Integrated Simulation Technology Introduction Guide (Calibration Parameter)	Learning about the calibration parameters created using the 3D Equipment Model Creation Wizard for the Vision & Robot integrated simulation.	Describes calibration parameters created using the 3D Equipment Model Creation Wizard for the Vision & Robot integrated simulation.
Z368		Vision Sensor FH Series Conveyor Tracking Application Programming Guide	Learning about the setup procedure of the wizard style calibration for cameras, robots, or conveyors.	Describes how to configure and operate Conveyor Tracking Calibration Wizard on Sysmac Studio on FH Sensor Controllers.
Z369		Vision Sensor FH Series Operation Manual Sysmac Studio Calibration Plate Print Tool	Learning about the setup procedure for printing the Pattern on a Calibration Plate used for calibration for cameras and robots on Sysmac Studio.	Describes how to configure and operate Calibration Plate Print Tool on Sysmac Studio on FH Sensor Controllers.
Z370		Vision Sensor FH Series Operation Manual Sysmac Studio Conveyor Tracking Calibration Wizard Tool	Learning about the setting procedure of sample macros for conveyor tracking.	Describes the setting procedure of sample macros used for applications of conveyor tracking on FH Sensor Controllers.
Z371		Vision Sensor FH Series Operation Manual Sysmac Studio Conveyor Panorama Display Tool	Learning about the setup procedure of panorama display for image capture of targets on conveyors.	Describes how to configure and operate the Conveyor Panorama Display tool on Sysmac Studio on FH Sensor Controllers.

* You can use only with NJ-series CPU Unit.

Microsoft product screen shot(s) reprinted with permission from Microsoft Corporation. MATLAB® and Simulink® are registered trademarks of The MathWorks® Inc. Safety over EtherCAT® is registered trademark and patented technology, licensed by Beckhoff Automation GmbH, Germany. Other company names and product names in this document are the trademarks or registered trademarks of their respective companies.

OMRON Corporation Industrial Automation Company
Kyoto, JAPAN

Contact: www.ia.omron.com

Regional Headquarters

OMRON EUROPE B.V.

Sensor Business Unit

Carl-Benz-Str. 4, D-71154 Nufringen, Germany
Tel: (49) 7032-811-0/Fax: (49) 7032-811-199

OMRON ELECTRONICS LLC

2895 Greenspoint Parkway, Suite 200
Hoffman Estates, IL 60169 U.S.A.
Tel: (1) 847-843-7900/Fax: (1) 847-843-7787

OMRON ASIA PACIFIC PTE. LTD.

No. 438A Alexandra Road # 05-05/08 (Lobby 2),
Alexandra Technopark,
Singapore 119967
Tel: (65) 6835-3011/Fax: (65) 6835-2711

OMRON (CHINA) CO., LTD.

Room 2211, Bank of China Tower,
200 Yin Cheng Zhong Road,
PuDong New Area, Shanghai, 200120, China
Tel: (86) 21-5037-2222/Fax: (86) 21-5037-2200

Authorized Distributor:

© OMRON Corporation 2015-2017 All Rights Reserved.
In the interest of product improvement,
specifications are subject to change without notice.

CSM_4_4_0617
Cat. No. P089-E1-08

Printed in Japan
0617 (0415)