



## PCB Terminals

Contact form	Model	Rated voltage
4PST-NO	G7J-4A-P	24, 50, 100/120, 200/240 VAC 12, 24, 48, 100 VDC
3PST-NO/ SPST-NC	G7J-3A1B-P	24, 50, 100/120, 200/240 VAC 12, 24, 48, 100 VDC
DPST-NO/DPST- NC	G7J-2A2B-P	24, 50, 100/120, 200/240 VAC 12, 24, 48, 100 VDC

## PCB Terminals (Bifurcated Contact)

Contact form	Model	Rated voltage
4PST-NO	G7J-4A-PZ	200/240 VAC 24 VDC
3PST-NO/ SPST-NC	G7J-3A1B-PZ	200/240 VAC 12, 24 VDC

## W-bracket Screw Terminals

Contact form	Model	Rated voltage
4PST-NO	G7J-4A-B	24, 50, 100/120, 200/240 VAC 12, 24, 48, 100 VDC
3PST-NO/ SPST-NC	G7J-3A1B-B	24, 50, 100/120, 200/240 VAC 12, 24, 48, 100 VDC
DPST-NO/ DPST-NC	G7J-2A2B-B	24, 50, 100/120, 200/240 VAC 12, 24, 48, 100 VDC

## ■ Accessories (Order Separately)

Name	Model	Applicable Relay
W-bracket	R99-04 for G5F	G7J-4A-B G7J-3A1B-B(Z) G7J-2A2B-B G7J-4A-T(Z) G7J-3A1B-T G7J-2A2B-T

## Application Examples

- Compressors for air conditioners and heater switching controllers.
- Switching controllers for power tools or motors.
- Lamp controls, motor drivers, and power supply switching controllers in copy machines, facsimile machines, and other office equipment.
- Power controllers for packers or food processing equipment.
- Power controllers for inverters.

## Screw Terminals (Bifurcated Contact)

Contact form	Model	Rated voltage
3PST-NO/ SPST-NC	G7J-3A1B-BZ	200/240 VAC 12, 24 VDC

## W-bracket Tab Terminals

Contact form	Model	Rated voltage
4PST-NO	G7J-4A-T	24, 50, 100/120, 200/240 VAC 12, 24, 48, 100 VDC
3PST-NO/ SPST-NC	G7J-3A1B-T	24, 50, 100/120, 200/240 VAC 12, 24, 48, 100 VDC
DPST-NO/ DPST-NC	G7J-2A2B-T	24, 50, 100/120, 200/240 VAC 12, 24, 48, 100 VDC

## W-bracket Tab Terminals (Bifurcated Contact)

Contact form	Model	Rated voltage
4PST-NO	G7J-4A-TZ	200/240 VAC

Consult your OMRON representative for details on models not mentioned in this document.

# Specifications

## ■ Coil Ratings

	Rated voltage	Rated current	Coil resistance	Must-operate voltage	Must-release voltage	Max. voltage	Power consumption
AC	24 VAC	75 mA	---	75% max. of rated voltage	15% min. of rated voltage	110% of rated voltage	Approx. 1.8 to 2.6 VA
	50 VAC	36 mA	---				
	100 to 120 VAC	18 to 21.6 mA	---				
	200 to 240 VDC	9 to 10.8 mA	---				
DC	12 VDC	167 mA	72 Ω		10% min. of rated voltage		Approx. 2.0 W
	24 VDC	83 mA	288 Ω				
	48 VDC	42 mA	1,150 Ω				
	100 VDC	20 mA	5,000 Ω				

- Note:**
- The rated current and coil resistance are measured at a coil temperature of 23°C with tolerances of +15%/–20% for AC rated current and ±15% for DC coil resistance. (The values given for AC rated current apply at 50 Hz or 60 Hz.)
  - Performance characteristic data are measured at a coil temperature of 23°C.
  - The maximum voltage is one that is applicable to the Relay coil at 23°C.

## ■ Contact Ratings

Item	Resistive load ( $\cos \phi = 1$ )	Inductive load ( $\cos \phi = 0.4$ )	Resistive load
Contact mechanism	Double break		
Contact material	Ag alloy		
Rated load	NO: 25 A at 220 VAC (24 A at 230 VAC) NC: 8 A at 220 VAC (7.5 A at 230 VAC)		NO: 25 A at 30 VDC NC: 8 A at 30 VDC
Rated carry current	NO: 25 A (1 A) NC: 8 A (1 A)		
Max. switching voltage	250 VAC		125 VDC
Max. switching current	NO: 25 A (1 A) NC: 8 A (1 A)		

**Note:** The values in parentheses indicate values for a bifurcated contact.

## ■ Characteristics

Contact resistance (see note 2)	100 mΩ max.
Operate time (see note 3)	50 ms max.
Release time (see note 3)	50 ms max.
Max. operating frequency	Mechanical: 1,800 operations/hr Electrical: 1,800 operations/hr
Insulation resistance (see note 4)	1,000 MΩ min. (at 500 VDC)
Dielectric strength	4,000 VAC, 50/60 Hz for 1 min between coil and contacts 4,000 VAC, 50/60 Hz for 1 min between contacts of different polarity 2,000 VAC, 50/60 Hz for 1 min between contacts of same polarity
Impulse withstand voltage	10,000 V between coil and contact (with 1.2 x 50 μs impulse wave)
Vibration resistance	Destruction: 10 to 55 to 10 Hz, 0.75-mm single amplitude (1.5-mm double amplitude) Malfunction: NO:10 to 55 to 10 Hz, 0.75-mm single amplitude (1.5-mm double amplitude) NC:10 to 26 to 10 Hz, 0.75-mm single amplitude (1.5-mm double amplitude)
Shock resistance	Destruction: 1,000 m/s <sup>2</sup> Malfunction: NO:100 m/s <sup>2</sup> NC:20 m/s <sup>2</sup>
Endurance	Mechanical: 1,000,000 operations min. (at 1,800 operations/hr) Electrical: 100,000 operations min. (at 1,800 operations/hr) (see note 5)
Error rate (see note 6)	100 mA at 24 VDC (bifurcated contact: 24 VDC 10 mA)
Ambient temperature	Operating: –25°C to 60°C (with no icing or condensation)
Ambient humidity	Operating: 5% to 85%
Weight	PCB terminal: approx. 140 g Screw terminal: approx. 165 g Quick-connect terminal: approx. 140 g

- Note:**
1. The above values are all initial values.
  2. The contact resistance was measured with 1 A at 5 VDC using the voltage drop method.
  3. The operate and the release times were measured with the rated voltage imposed with any contact bounce ignored at an ambient temperature of 23°C.
  4. The insulation resistance was measured with a 500-VDC megger applied to the same places as those used for checking the dielectric strength.
  5. The electrical endurance was measured at an ambient temperature of 23°C.
  6. This value was measured at a switching frequency of 60 operations per minute.

## ■ Approved Standards

The G7J satisfies the following international standards. Approval for some international markings and symbols are still pending, however, and information on them will be added when they are approved.

### UL (File No. E41643)

### CSA (File No. LR35535)

Coil ratings	Contact ratings		Number of test operations
24 to 265 VAC 6 to 110 VDC	NO contact	25 A 277 VAC, Resistive	30,000
		25 A 120 VAC, General Use	
		25 A 277 VAC, General Use	
		25 A 240 VAC, General Use	100,000
		1.5 kW 120 VAC, Tungsten	6,000
		1.5 hp 120 VAC	1,000
		3 hp 240/265/277 VAC	30,000
		3-phase 3 hp 240/265/277 VAC	
		3-phase 5 hp 240/265/277 VAC	
		20FLA/120LRA 120 VAC	25,000
		17FLA/102LRA 277 VAC	
		TV-10 120 VAC	
		25 A 30 VDC, Resistive	30,000
		*1 A 277 VAC, General Use	6,000
	NC contact	8 A 277 VAC, Resistive	30,000
		8 A 120 VAC, General Use	
		8 A 277 VAC, General Use	
		8 A 30 VDC, Resistive	
		*1 A 277 VAC, General Use	6,000

**Note:** \*These ratings are bifurcated contact ratings.

### Reference

UL approval: UL508 for industrial control devices

CSA approval: CSA C22.2 No. 14 for industrial control devices

### VDE (File No. 5381UG)

Model	Coil ratings	Contact ratings	
		NO contact	NC contact
G7J-4A-B(P) (T)	6, 12, 24, 48, 100 VDC	25 A 240 VAC $\cos\phi = 0.4$	8 A 240 VAC $\cos\phi = 0.4$
G7J-2A2B(P) (T)	24, 50, 100 to 120, 200 to 240 VAC	25 A 240 VAC $\cos\phi = 1$	8 A 240 VAC $\cos\phi = 1$
G7J-3A1B-B(P) (T)		25 A 30 VDC $L/R \geq 1$	8 A 30 VDC $L/R \geq 1$

**Note:** Add the suffix "-KM" to the model number when ordering.

### Reference

VDE approval: EN60255-1-00: 1997

EN60255-23: 1996

**KEMA (File No. 2001291.02)**

Model	Coil ratings	Contact ratings
		NO contact
G7J-4A-B(P) (T) (Z) G7J-2A2B(P) (T)	200 to 240 VAC	Class AC1: 25 A at 220 VAC 11.5 A at 380 to 480 VAC
G7J-3A1B-B(P) (T) (Z)	6, 12, 24, 48, 100 VDC 24, 50, 100 to 120, 200 to 240 VAC	Class AC3: 11.5 A at 220 VAC and 8.5 A at 380 to 480 VAC *Class AC1: 1 A at 220 VAC

**Note:** Add the suffix “-KM” to the model number when ordering.

\*This rating is the bifurcated contact rating.

**Reference**

KEMA approval: EN60947-4-1 for contacts

**Engineering Data**

■ **Maximum Switching Power**

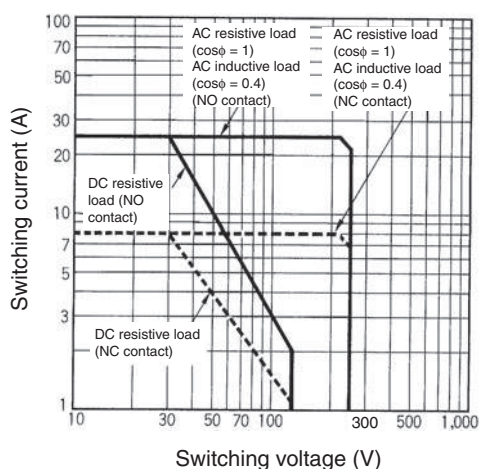

■ **Endurance**

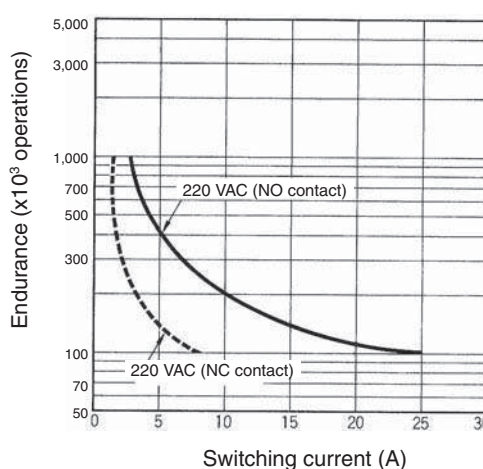

■ **Malfunctioning Shock**

G7J-2A2B

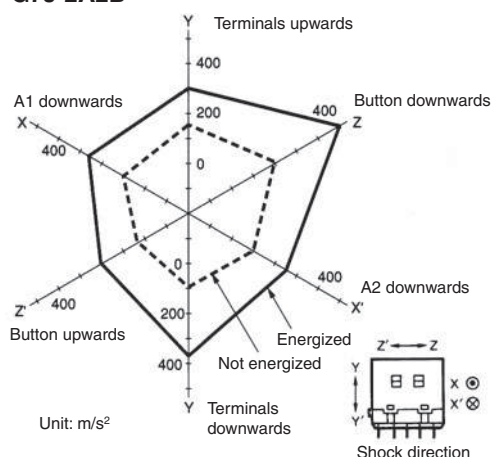

Number of samples: 5

Measurement conditions: Increase and decrease the specified shock gradually imposed in  $\pm X$ ,  $\pm Y$ , and  $\pm Z$  directions three times each with the Relay energized and not energized to check the shock values that cause the Relay to malfunction.

Criteria: There must not be any contact separation for 1 ms or greater with a shock of  $100 m/s^2$  imposed when the coil is energized or with a shock of  $20 m/s^2$  when the coil is not energized.

### ■ Ambient Temperature vs. Must-operate and Must-release Voltage

G7J 100 to 120 VAC

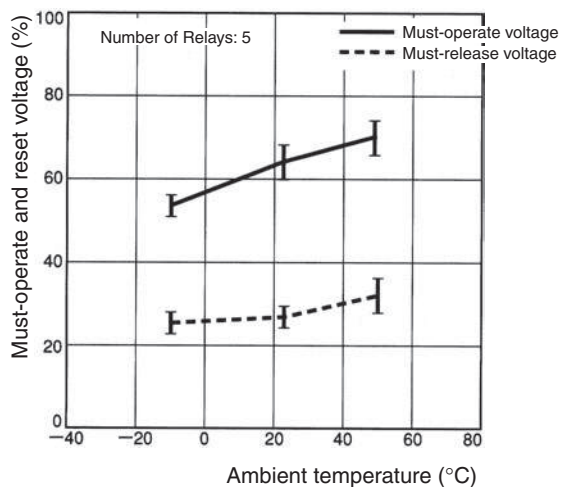

### ■ Ambient Temperature vs. Coil Temperature Rise

G7J-4A 100 to 120 VAC

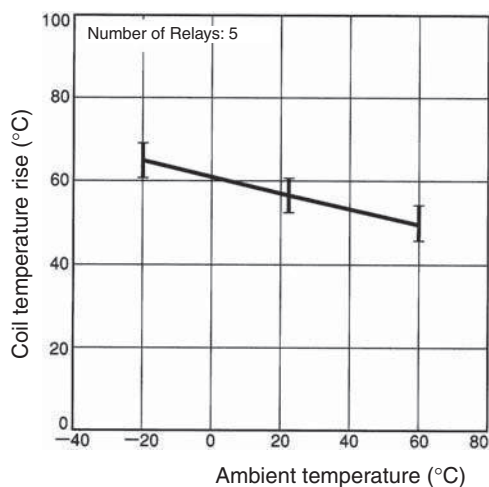

G7J 24 VDC

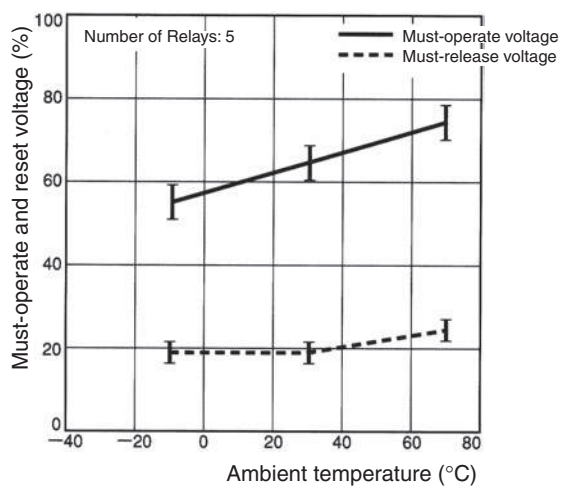

G7J-4A 24 VDC

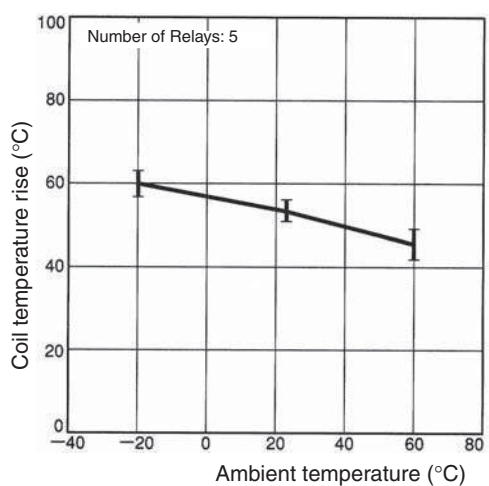

### Motor Load

Item	G7J-4A-P, G7J-3A1B-P, G7J-4A-B, G7J-3A1B-B, G7J-4A-T, G7J-3A1B-T
Load	3φ, 220 VAC, 2.7 kW (with a inrush current of 78 A and a breaking current of 13 A)
Endurance	Electrical: 100,000 operations min.

# Dimensions

Note: All units are in millimeters unless otherwise indicated.

## Screw Terminals with W-bracket

G7J-4A-B, G7J-3A1B-B, G7J-3A1B-BZ, G7J-2A2B-B

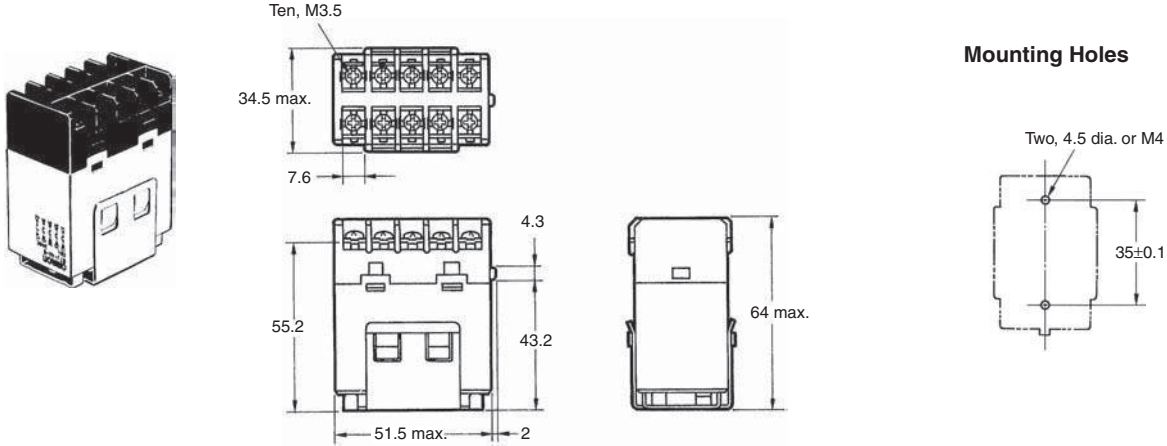

## Quick-connect Terminals with W-bracket

G7J-4A-T, G7J-4A-TZ, G7J-3A1B-T, G7J-2A2B-T

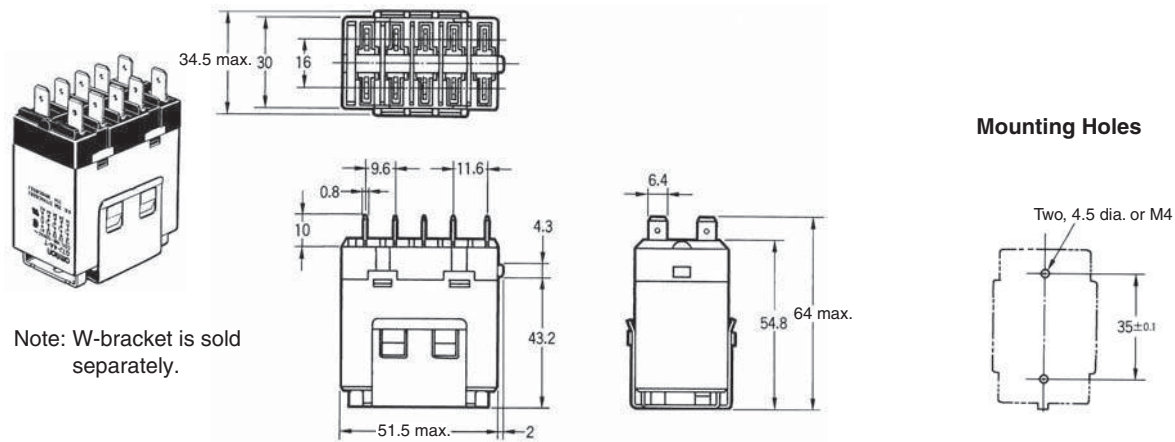

Note: W-bracket is sold separately.

## PCB Terminals with PCB Mounting

G7J-4A-P, G7J-4A-PZ, G7J-3A1B-P, G7J-3A1B-PZ, G7J-2A2B-P

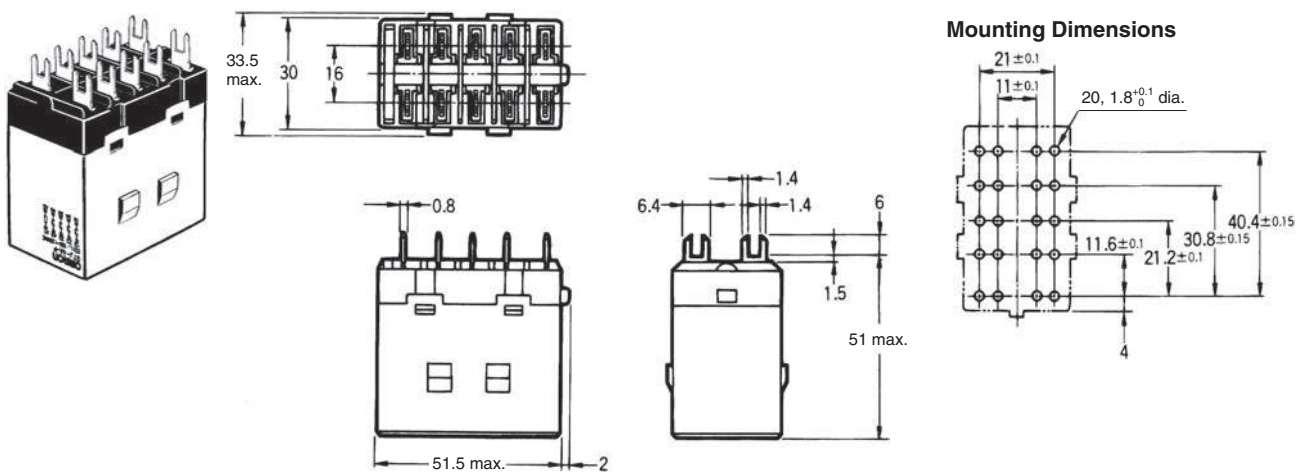

## Terminal Arrangement/Internal Connections

G7J-4A-P  
G7J-4A-B  
G7J-4A-T

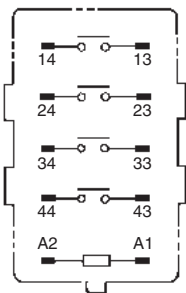

G7J-3A1B-P  
G7J-3A1B-B  
G7J-3A1B-T

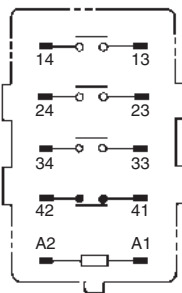

The coil has no polarity.

G7J-2A2B-P  
G7J-2A2B-B  
G7J-2A2B-T

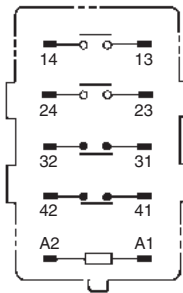

**Note:** Terminals 43 and 44 of the G7J-4A-P(T) and contacts 41 and 42 of the G7J-3A1B-P(B) are bifurcated contacts.

## Accessories (Order Separately)

R99-04 W-bracket (for G5F)

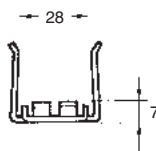
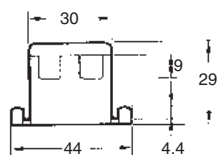
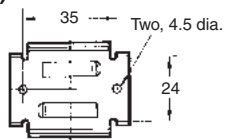
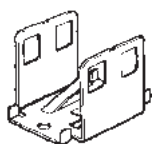

### Mounting Holes

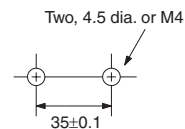



# Safety Precautions

Refer to *Safety Precautions for All Relays*.

## ■ Correct Use

### Installation

PCB Terminal-equipped Relays weigh approximately 140 g. Be sure that the PCB is strong enough to support them. We recommend dual-side through-hole PCBs to reduce solder cracking from heat stress.

Mount the G7J with its test button facing downwards. The Relay may malfunction due to shock if the test button faces upwards. Be careful not to press the test button by mistake because the contacts will go ON if the test button is pressed.

If the normal mounting direction is not used, carbides or powder from contact abrasion that results from load switching will accumulate inside the Relay. If the Relay is used past its endurance in this state, insulation failure between circuits of different polarity or Relay burning may occur.

Be sure to use the test button for test purposes only. The test button is used for Relay circuit tests, such as a circuit continuity test. Do not attempt to switch the load with the test button.

If a voltage is applied to the coil, the test button will retract in an ON state (i.e., an excited state).

### Micro Loads

The G7J is used for switching power loads, such as motor, transformer, solenoid, lamp, and heater loads. Do not use the G7J for switching minute loads, such as signals. Use a Relay with a bifurcated contact construction for switching micro loads, in which case, however, only SPST-NO or SPST-NC output is obtained.

### Soldering PCB Terminals

Be sure to solder the PCB terminals manually only. In the case of automatic soldering, some flux may stick to the test button and the G7J. As a result, the G7J may malfunction.

The G7J is not of enclosed construction. Therefore, do not wash the G7J with water or any detergent.

### Connecting

Refer to the following diagram when connecting a wire with a screw terminal to the G7J.

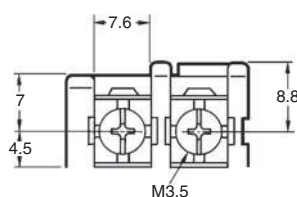

Allow suitable slack on leads when wiring, and do not subject the terminals to excessive force.

Tighten the terminal screws with torque 0.78 to 1.18 N·m. Loose screws result in disconnection of lead wire, malfunction or fire.

### Faston Tabs

Do not impose excessive external force on the G7J in the horizontal or vertical directions when inserting the G7J to the Faston receptacle or pulling the G7J out from the Faston receptacle. Do not attempt to insert or pull out more than one G7J Unit together.

Do not solder the tab terminals.

Terminal	Receptacle	Housing
#250 terminal (6.35 mm in width)	AMP170333-1 (170327-1) AMP170334-1 (170328-1) AMP170335-1 (170329-1)	AMP172076-1: natural AMP172076-4: yellow AMP172076-5: green AMP172076-6: blue

**Note:** Numbers in parentheses are for air feed use.

### Operating Coil

#### Internal Connections of Coils

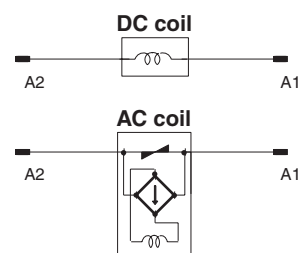

If a transistor drives the G7J, check the leakage current, and connect a bleeder resistor if necessary.

The AC coil is provided with a built-in full-wave rectifier. If a triac, such as an SSR, drives the G7J, the G7J may not release. Use the Power MOS FET Relay in this case.

ALL DIMENSIONS SHOWN ARE IN MILLIMETERS.

To convert millimeters into inches, multiply by 0.03937. To convert grams into ounces, multiply by 0.03527.

In the interest of product improvement, specifications are subject to change without notice.

## Terms and Conditions Agreement

### Read and understand this catalog.

Please read and understand this catalog before purchasing the products. Please consult your OMRON representative if you have any questions or comments.

### Warranties.

(a) Exclusive Warranty. Omron's exclusive warranty is that the Products will be free from defects in materials and workmanship for a period of twelve months from the date of sale by Omron (or such other period expressed in writing by Omron). Omron disclaims all other warranties, express or implied.

(b) Limitations. OMRON MAKES NO WARRANTY OR REPRESENTATION, EXPRESS OR IMPLIED, ABOUT NON-INFRINGEMENT, MERCHANTABILITY OR FITNESS FOR A PARTICULAR PURPOSE OF THE PRODUCTS. BUYER ACKNOWLEDGES THAT IT ALONE HAS DETERMINED THAT THE PRODUCTS WILL SUITABLY MEET THE REQUIREMENTS OF THEIR INTENDED USE.

Omron further disclaims all warranties and responsibility of any type for claims or expenses based on infringement by the Products or otherwise of any intellectual property right. (c) Buyer Remedy. Omron's sole obligation hereunder shall be, at Omron's election, to (i) replace (in the form originally shipped with Buyer responsible for labor charges for removal or replacement thereof) the non-complying Product, (ii) repair the non-complying Product, or (iii) repay or credit Buyer an amount equal to the purchase price of the non-complying Product; provided that in no event shall Omron be responsible for warranty, repair, indemnity or any other claims or expenses regarding the Products unless Omron's analysis confirms that the Products were properly handled, stored, installed and maintained and not subject to contamination, abuse, misuse or inappropriate modification. Return of any Products by Buyer must be approved in writing by Omron before shipment. Omron Companies shall not be liable for the suitability or unsuitability or the results from the use of Products in combination with any electrical or electronic components, circuits, system assemblies or any other materials or substances or environments. Any advice, recommendations or information given orally or in writing, are not to be construed as an amendment or addition to the above warranty.

See <http://www.omron.com/global/> or contact your Omron representative for published information.

### Limitation on Liability; Etc.

OMRON COMPANIES SHALL NOT BE LIABLE FOR SPECIAL, INDIRECT, INCIDENTAL, OR CONSEQUENTIAL DAMAGES, LOSS OF PROFITS OR PRODUCTION OR COMMERCIAL LOSS IN ANY WAY CONNECTED WITH THE PRODUCTS, WHETHER SUCH CLAIM IS BASED IN CONTRACT, WARRANTY, NEGLIGENCE OR STRICT LIABILITY.

Further, in no event shall liability of Omron Companies exceed the individual price of the Product on which liability is asserted.

### Suitability of Use.

Omron Companies shall not be responsible for conformity with any standards, codes or regulations which apply to the combination of the Product in the Buyer's application or use of the Product. At Buyer's request, Omron will provide applicable third party certification documents identifying ratings and limitations of use which apply to the Product. This information by itself is not sufficient for a complete determination of the suitability of the Product in combination with the end product, machine, system, or other application or use. Buyer shall be solely responsible for determining appropriateness of the particular Product with respect to Buyer's application, product or system. Buyer shall take application responsibility in all cases.

NEVER USE THE PRODUCT FOR AN APPLICATION INVOLVING SERIOUS RISK TO LIFE OR PROPERTY OR IN LARGE QUANTITIES WITHOUT ENSURING THAT THE SYSTEM AS A WHOLE HAS BEEN DESIGNED TO ADDRESS THE RISKS, AND THAT THE OMRON PRODUCT(S) IS PROPERLY RATED AND INSTALLED FOR THE INTENDED USE WITHIN THE OVERALL EQUIPMENT OR SYSTEM.

### Programmable Products.

Omron Companies shall not be responsible for the user's programming of a programmable Product, or any consequence thereof.

### Performance Data.

Data presented in Omron Company websites, catalogs and other materials is provided as a guide for the user in determining suitability and does not constitute a warranty. It may represent the result of Omron's test conditions, and the user must correlate it to actual application requirements. Actual performance is subject to the Omron's Warranty and Limitations of Liability.

### Change in Specifications.

Product specifications and accessories may be changed at any time based on improvements and other reasons. It is our practice to change part numbers when published ratings or features are changed, or when significant construction changes are made. However, some specifications of the Product may be changed without any notice. When in doubt, special part numbers may be assigned to fix or establish key specifications for your application. Please consult with your Omron's representative at any time to confirm actual specifications of purchased Product.

### Errors and Omissions.

Information presented by Omron Companies has been checked and is believed to be accurate; however, no responsibility is assumed for clerical, typographical or proofreading errors or omissions.

2015.10

In the interest of product improvement, specifications are subject to change without notice.

**OMRON Corporation**  
Industrial Automation Company

<http://www.ia.omron.com/>

(c)Copyright OMRON Corporation 2015 All Right Reserved.