



# Ultracompact, Ultrathin Photoelectric Sensors with Built-in Amplifiers

E3T Series



## The Improved E3T Series

# Makes Mounting and Installation Simpler and Smoother

Suitable for Applications in the Rechargeable Battery Industry

### Small Cylindrical Sensors

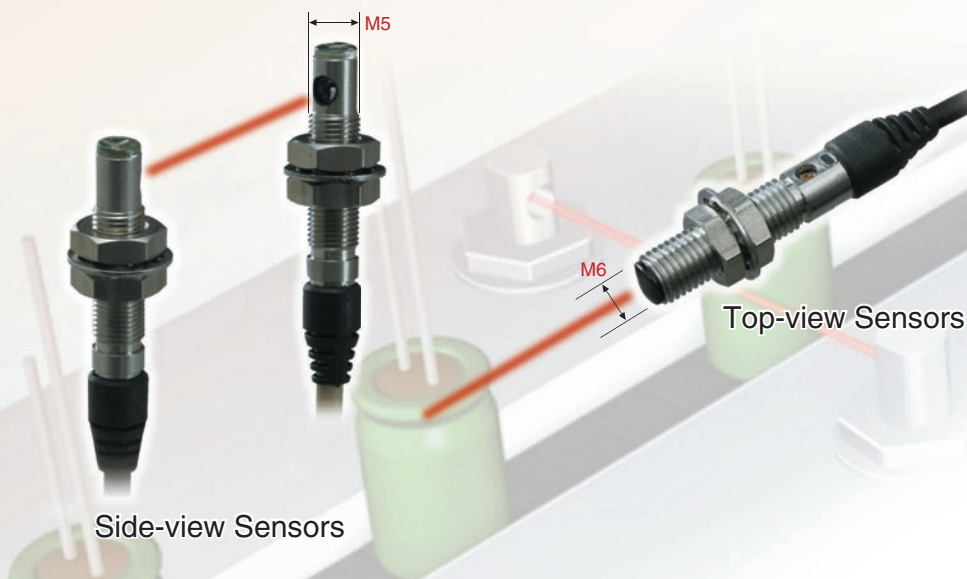

### M3-mounting Sensors

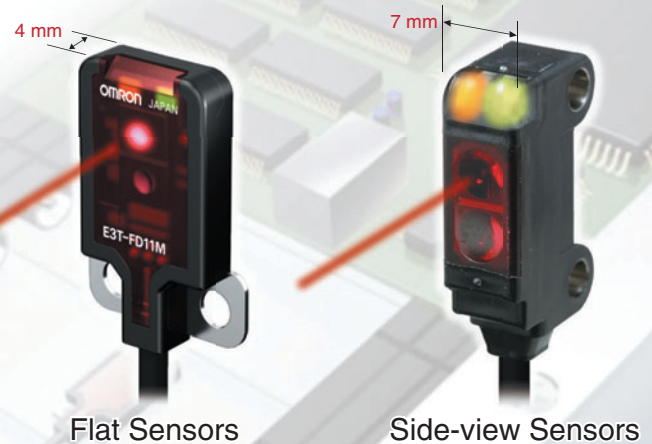

realizing

## Simple, Low-cost Installation, Setup, and Operation

### New Small Cylindrical Sensors

With Square Sensors:

Installation

- Time is required to tighten screws.
- Mounting brackets are sometimes required.



But with Small Cylindrical Sensors:

#### Less Drilling and Tightening Work.

Work is reduced because holes do not need to be threaded and there is only one place to tighten.

AND

#### Mounting without Brackets.

For Through-beam Sensors, both Top-view and Side-view Models are available. Select the shape according to installation conditions to mount directly to the system without brackets.

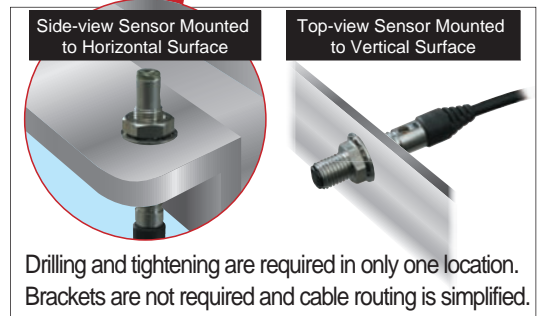
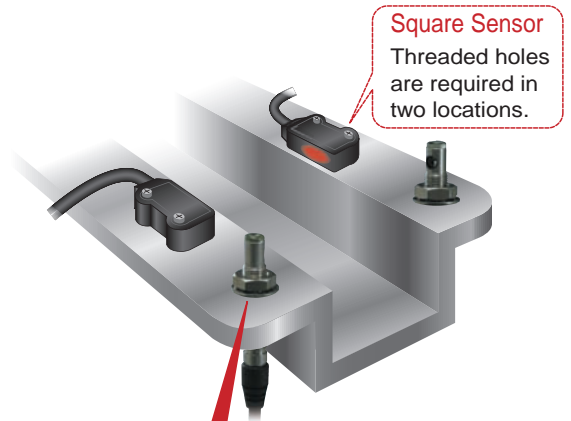

## Sure Installation without Stress

### Side-view and Flat Sensor Models for M3 Mounting

With Previous M3-mounting Sensors:

Installation

- Sensor heads were large.

With Previous M2-mounting Sensors:

- The small screws were hard to handle.

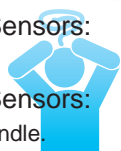

With M3-mounting Sensors:

#### Compact M3 Mounting. Essentially the Same Size as M2-mounting Sensors.

The width and depth are essentially the same as previous M2-mounting sensors. Easier application without increasing space requirements.

AND

#### Secure Tightening and Mounting. Stainless-steel Mounting Plates or Sleeves

Side-view Sensors mount with SUS304 sleeves, while Flat Sensors mount with SUS304 plates. The reliable strength provide sure tightening that will not come loose. Damage from overtightening is also prevented for sure mounting.

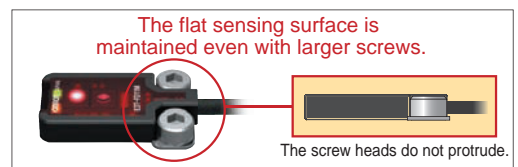
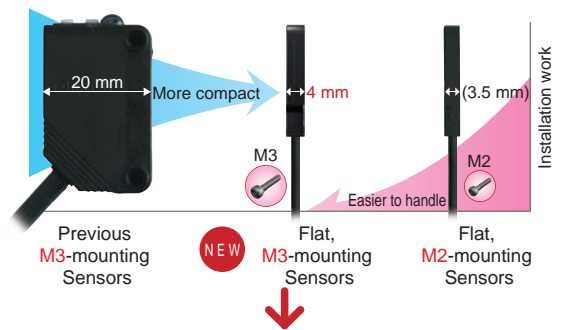

# Small Cylindrical Sensors

With Fiber Sensors:

- **Installation** Space is required for the Amplifier.
- **Setup** Setup and installation are troublesome.
- **Operation** Initial and electrical costs are high.

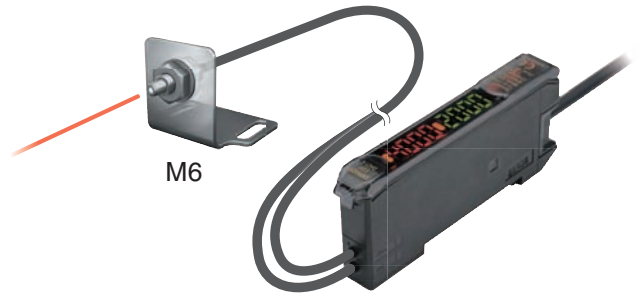

But with Small Cylindrical Sensors:

**Essentially the Same Size as the Fiber Head. But No Amplifier Is Required.**

Mounting is possible in narrow spaces where only fiber sensors could previously be used. The built-in amplifier and teach-free operation reduce wiring and setup work. And initial costs and electrical costs are also reduced.

Diffuse-reflective Sensors (with Sensitivity Adjuster)

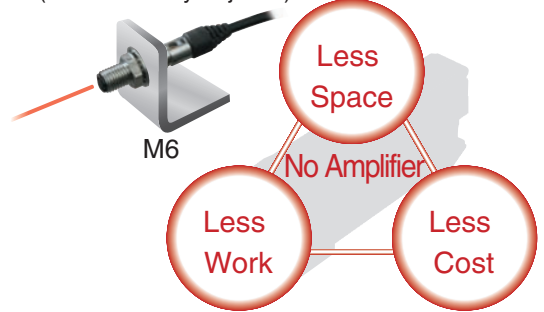

## Overall Features

### Many Compact Shapes for Various Applications

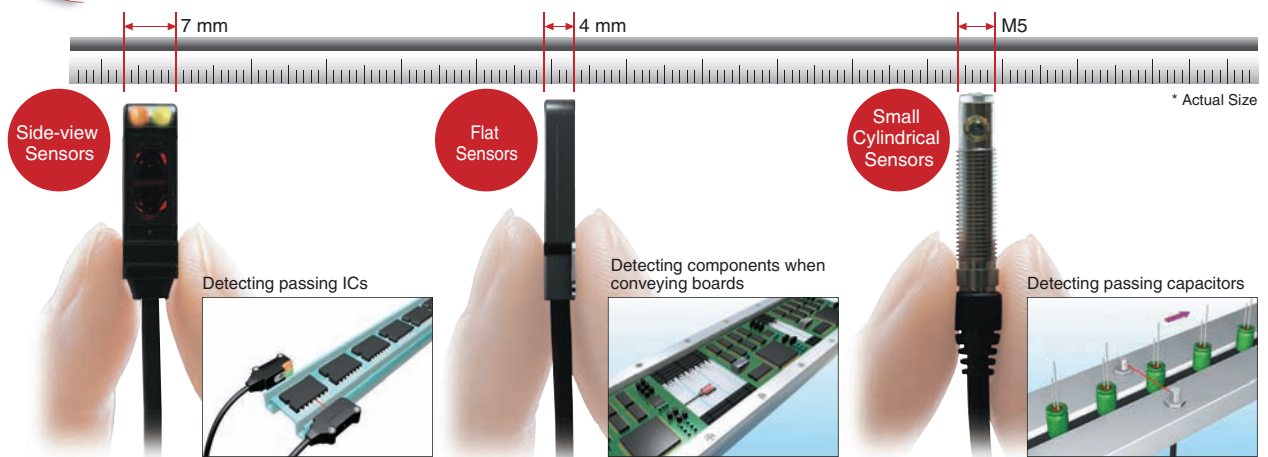

## Ideal for Rechargeable Battery Manufacturing Lines

**All Metal Parts Are Stainless Steel. No Worries About Conductive Copper Intrusion.**

The case, nuts, and washers of the Cylindrical Sensors are all stainless steel, as are the mounting plates and sleeves of the M3-mounting Sensors. Harmful copper, zinc, and nickel plating are not used, enabling reliable application in rechargeable battery manufacturing lines. Stainless-steel screws are also available, for immediate application for rechargeable batteries.



## Ordering Information

### Small Cylindrical Sensors

Sensing method	Appearance	Connection method	Sensing distance	Operation mode	Model	
					NPN output	PNP output
Through-beam		Pre-wired (2 m)	1 m	Dark-ON	E3T-CT12 2M	E3T-CT14 2M
			500 mm	Dark-ON	E3T-CT22S 2M	E3T-CT24S 2M
Diffuse-reflective (with adjuster)			3 to 50 mm	Light-ON	E3T-CD11 2M	E3T-CD13 2M

### Dimensions (Unit: mm)

#### Top-view Through-beam Sensors

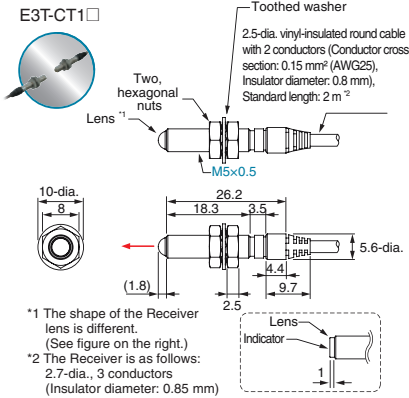

#### Side-view Through-beam Sensors

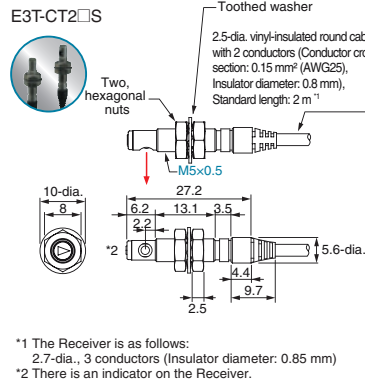

#### Top-view Diffuse-reflective Sensors

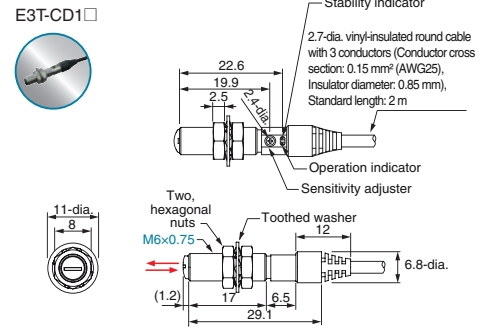

\* Recommended Mounting Hole: M5 Through-beam Sensors: 5.5<sup>+0.5</sup><sub>0</sub>, M6 Diffuse-reflective Sensors: 6.5<sup>+0.5</sup><sub>0</sub>

### M3-mounting Sensors

Sensing method	Appearance	Connection method	Sensing distance	Operation mode	Model	
					NPN output	PNP output
Through-beam *1 *2		Pre-wired (2 m)	1 m	Light-ON	E3T-ST11M 2M	E3T-ST13M 2M
			300 mm	Dark-ON	E3T-ST12M 2M	E3T-ST14M 2M
			5 to 30 mm	Light-ON	E3T-ST21M 2M	E3T-ST23M 2M
				Dark-ON	E3T-ST22M 2M	E3T-ST24M 2M
Diffuse-reflective		Pre-wired (2 m)	5 to 30 mm	Light-ON	E3T-FD11M 2M	E3T-FD13M 2M
				Dark-ON	E3T-FD12M 2M	E3T-FD14M 2M
Convergent-reflective		Pre-wired (2 m)	5 to 15 mm	Light-ON	E3T-SL11M 2M	E3T-SL13M 2M
				Dark-ON	E3T-SL12M 2M	E3T-SL14M 2M
				Light-ON	E3T-SL21M 2M	E3T-SL23M 2M
				Dark-ON	E3T-SL22M 2M	E3T-SL24M 2M

\*1. The model number of the Emitter is expressed by adding an "L" to the set model number in the table. Example: E3T-ST11-L 2M  
The model number of the Receiver is expressed by adding a "D" to the set model number in the table. Example: E3T-ST11-D 2M  
Orders for individual Emitters and Receivers are accepted. (Modifications are required for some models.)

\*2. Infra-red models are also available. For details, refer to your OMRON website.

### Dimensions (Unit: mm)

#### Side-view Through-beam Sensors

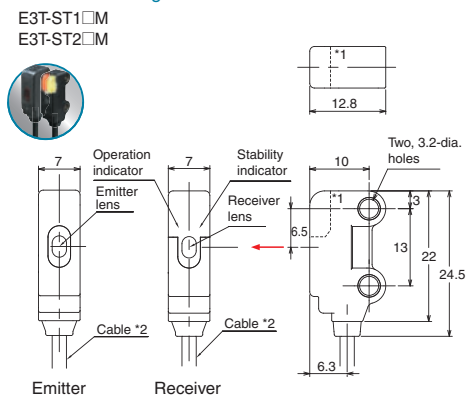

#### Flat Diffuse-reflective Sensors

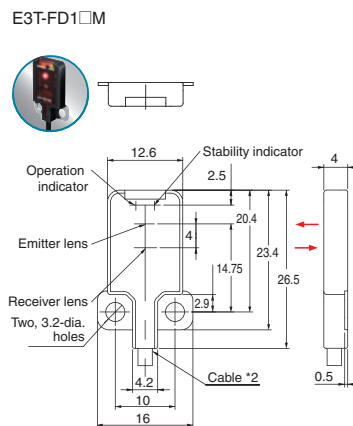

#### Side-view Convergent-reflective Sensors

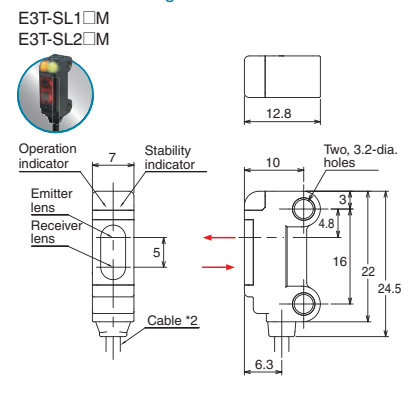

\*1. The dotted line indicates the Receiver.

\*2. 4-dia. vinyl-insulated round cable with 2 or 3 conductors (Conductor cross section: 0.1 mm<sup>2</sup> (AWG27), Insulator diameter: 0.7 mm), Standard length: 2 m  
For Through-beam Sensors, the Emitter has two conductors and the Receiver has three conductors. Diffuse-reflective Sensors and Convergent-reflective Sensors have three conductors.

## Accessories

These accessories are not included with the Sensor. Order them separately if required.

Name		Applicable Sensor	Model	Quantity	Remarks
Slits for Through-beam Side-view Sensors	0.5 dia.	E3T-ST1□M	E39-S76A	One each for Emitter and Receiver (2)	Sensing distance 100 mm
	1 dia.		E39-S76B		Sensing distance 300 mm
M3 Mounting Bracket for Side-view Sensors *		E3T-S□□□M	E39-L166	1	Nut plate provided
M3 Mounting Bracket for Flat Sensors		E3T-FD□□M	E39-L167		---
M3 Back-mounting Spacer for Flat Sensors		E3T-FD□□M	E39-L168	1	Use this Spacer when mounting a Sensor from the back.
M3 SUS304 Screw Set for Flat Sensors		E3T-FD□□M	E39-L170	Two bolts with hexagonal hole (M3x6)	---
M3 SUS304 Screw Set for Side-view Sensors *		E3T-S□□□M	E39-L171	Two each of the following: Bolt with hexagonal hole (M3x15), Hexagonal nuts, Spring washers, Flat washers	---
M2 SUS304 Screw Set for Flat Sensors *		E3T-F□□□	E39-L172	Two bolts with hexagonal hole (M2x6)	The screw set that is provided with the Sensor is zinc-plated steel. Use this SUS Screw Set when stainless steel is required.
M2 SUS304 Screw Set for Side-view Sensors *		E3T-S□□□	E39-L173	Two each of the following: Bolt with hexagonal hole (M2x12), Hexagonal nuts, Spring washers, Flat washers	

\* For a Through-beam Sensor, order one Bracket or Screw Set for the Emitter and one for the Receiver.

## Ratings and Specifications

Sensing method		Through-beam				Diffuse-reflective		Convergent-reflective	
Appearance		Side-view		Cylindrical type		Cylindrical type	Flat	Side-view	
				Top-view	Side-view	Top-view			
NPN	Light-ON	E3T-ST11M	E3T-ST21M	---	---	E3T-CD11	E3T-FD11M	E3T-SL11M	E3T-SL21M
	Dark-ON	E3T-ST12M	E3T-ST22M	E3T-CT12	E3T-CT22S	---	E3T-FD12M	E3T-SL12M	E3T-SL22M
PNP	Light-ON	E3T-ST13M	E3T-ST23M	---	---	E3T-CD13	E3T-FD13M	E3T-SL13M	E3T-SL23M
	Dark-ON	E3T-ST14M	E3T-ST24M	E3T-CT14	E3T-CT24S	---	E3T-FD14M	E3T-SL14M	E3T-SL24M
Sensing distance		1 m	300 mm	1 m	500 mm	3 to 50 mm (100 × 100 mm white paper)	5 to 30 mm (50 × 50 mm white paper)	5 to 15 mm (50 × 50 mm white paper)	5 to 30 mm (50 × 50 mm white paper)
Standard sensing object		Opaque, 2-mm dia. min.		Opaque, 4-mm dia. min.	Opaque, 5-mm dia. min.	---			
Minimum detectable object (typical)		Opaque, 2-mm dia.		---		---	0.15-mm dia. (sensing distance 10 mm)		
Hysteresis (white paper)		---				15% or less of the sensing distance	6 mm max.	2 mm max.	6 mm max.
Directional angle		Emitter: 2 to 20°, Receiver: 2 to 70°		Receiver: 2°	Receiver: 10°	---			
Light source (wavelength)		Red LED (650 nm)		Red LED (630 nm)	Red LED (625 nm)	Infrared LED (870 nm)	Red LED (650 nm)		
Power supply voltage		12 to 24 VDC ±10%, ripple (p-p) 10% max.							
Current consumption		30 mA max. (Emitter: 10 mA max., Receiver: 20 mA max.)		30 mA max. (Emitter: 15 mA max., Receiver: 15 mA max.)		20 mA max.			
Control output		Load power supply voltage: 26.4 VDC max. Load current: 50 mA max. (residual voltage: 2 V max. for load current of 10 to 50 mA, 1 V max. for load current of less than 10 mA), Open-collector output		Load power supply voltage: 30 VDC max. Load current: 80 mA max. (residual voltage: 1 V max.) Open-collector output		Load power supply voltage: 26.4 VDC max. Load current: 50 mA max. (residual voltage: 2 V max. for load current of 10 to 50 mA, 1 V max. for load current of less than 10 mA), Open-collector output			
Protection circuits		Power supply and control output reverse polarity protection Output short-circuit protection		Power supply reverse polarity protection Output short-circuit protection		Power supply and control output reverse polarity protection Output short-circuit protection Mutual interference prevention			
Response time		Operate or reset: 1 ms max.		Operate or reset: 0.5 ms max.		Operate or reset: 1 ms max.			
Ambient illumination		Incandescent lamp: 5,000 lx max.		Incandescent lamp: 3,000 lx max.		Incandescent lamp: 5,000 lx max.			
Ambient temperature range		Operating: -25 to +55°C Storage: -40 to +70°C (with no icing or condensation)		Operating: -25 to +55°C Storage: -30 to +70°C (with no icing or condensation)		Operating: -25 to +55°C Storage: -40 to +70°C (with no icing or condensation)			
Ambient humidity range		Operating: 35% to 85% Storage: 35% to 95% (with no condensation)		Operating or Storage: 35% to 85% (with no condensation)		Operating: 35% to 85% Storage: 35% to 95% (with no condensation)			
Insulation resistance		20 MΩ min. at 500 VDC							
Dielectric strength		1,000 VAC, 50/60 Hz for 1 min.		500 VAC, 50/60 Hz for 1 min.		1,000 VAC, 50/60 Hz for 1 min.			
Vibration resistance (destruction)		10 to 2,000 Hz, 1.5-mm double amplitude or 300 m/s <sup>2</sup> for 0.5 hours each in X, Y, and Z directions		10 to 55 Hz, 1.5-mm double amplitude for 2 hours each in X, Y, and Z directions		10 to 2,000 Hz, 1.5-mm double amplitude or 300 m/s <sup>2</sup> for 0.5 hours each in X, Y, and Z directions			
Shock resistance (destruction)		1,000 m/s <sup>2</sup> 3 times each in X, Y, and Z directions		500 m/s <sup>2</sup> 3 times each in X, Y, and Z directions		1,000 m/s <sup>2</sup> 3 times each in X, Y, and Z directions			
Degree of protection		IP67 (IEC 60529)		IP65 (IEC 60529)		IP67 (IEC 60529)			
Connection method		Pre-wired (standard length: 2 m)							
Weight		Approx. 40 g		Approx. 60 g		Approx. 40 g		Approx. 20 g	
Materials	Case	PBT (polybutylene terephthalate)		SUS303		PBT (polybutylene terephthalate)			
	Display window	Denatured polyarylate		Polysulfone		Epoxy		Denatured polyarylate	
	Lens	Denatured polyarylate		Polysulfone				Denatured polyarylate	
Accessories		Instruction manual <sup>*1</sup>		Instruction manual Hexagonal nuts <sup>*3</sup> Toothed washers <sup>*3</sup>		Instruction manual Hexagonal nuts <sup>*4</sup> Toothed washers <sup>*4</sup> Adjustment driver <sup>*5</sup>		Instruction manual <sup>*1</sup>	

\*1 Order the E39-L171 Screw Set separately if required.

\*2 Order the E39-L170 Screw Set separately if required.

\*3 A E39-M5 SUS Nut Set is included with the Sensor, but it can also be ordered separately.





\*4 A E39-M6 SUS Nut Set is included with the Sensor, but it can also be ordered separately.

\*5 A E39-G17 Adjustment Driver is included with the Sensor, but it can also be ordered separately.

## ■ Ordering Information

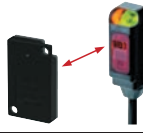
### E3T-series Sensors, M2-mounting Sensors

 Red light

Sensing method	Appearance	Connection method	Sensing distance	Operation mode	Model			
					NPN output	PNP output		
Through-beam (Emitter + Receiver) *1 *2		Pre-wired (2 m)	1 m (Sensitivity Adjustment Unit can be used.)	Light-ON	E3T-ST11 2M *5	E3T-ST13 2M *5		
				Dark-ON	E3T-ST12 2M *5	E3T-ST14 2M *5		
	300 mm		Light-ON	E3T-ST21 2M	E3T-ST23 2M			
			Dark-ON	E3T-ST22 2M	E3T-ST24 2M			
	500 mm		Light-ON	E3T-FT11 2M	E3T-FT13 2M			
			Dark-ON	E3T-FT12 2M	E3T-FT14 2M			
Retro-reflective		Pre-wired (2 m)	Using the E39-R4 Reflector provided 200 mm [30 mm] *3	Light-ON	E3T-SR41 2M *3 *5	E3T-SR43 2M *4 *5		
			Using the E39-R37-CA 100 mm [10 mm] *3	Dark-ON	E3T-SR42 2M *3 *5	E3T-SR44 2M *4 *5		
Diffuse-reflective			Pre-wired (2 m)	5 to 30 mm	Light-ON	E3T-FD11 2M *5	E3T-FD13 2M *5	
					Dark-ON	E3T-FD12 2M *5	E3T-FD14 2M *5	
Convergent-reflective				Pre-wired (2 m)	5 to 15 mm	Light-ON	E3T-SL11 2M *5	E3T-SL13 2M *5
						Dark-ON	E3T-SL12 2M *5	E3T-SL14 2M *5
		5 to 30 mm			Light-ON	E3T-SL21 2M *5	E3T-SL23 2M *5	
					Dark-ON	E3T-SL22 2M *5	E3T-SL24 2M *5	
BGS-reflective		Pre-wired (2 m)	1 to 15 mm		Light-ON	E3T-FL11 2M *5	E3T-FL13 2M *5	
					Dark-ON	E3T-FL12 2M *5	E3T-FL14 2M *5	
			1 to 30 mm	Light-ON	E3T-FL21 2M *5	E3T-FL23 2M *5		
				Dark-ON	E3T-FL22 2M *5	E3T-FL24 2M *5		

Note: The mounting holes on M2-mounting Sensors are SUS301 stainless steel.

- \*1. The model number of the Emitter is expressed by adding an "L" to the set model number in the table. Example: E3T-ST11-L 2M  
The model number of the Receiver is expressed by adding a "D" to the set model number in the table. Example: E3T-ST11-D 2M  
Orders for individual Emitters and Receivers are accepted. (Modifications are required for some models.)
- \*2. Infra-red models are also available. For details, refer to your OMRON website.
- \*3. Values in parentheses indicate the minimum required distance between the Sensor and Reflector.
- \*4. Models are available either with or without the E39-R37-CA Reflector included.  
Models with E39-R37-CA Reflector. E3T-SR4□-S Models without Reflector. E3T-SR4□-C
- \*5. Models with robot (bending-resistant) cable are also available with "R" in the model number. (Example: E3T-ST11R 2M)

**OMRON Corporation Industrial Automation Company**  
Tokyo, JAPAN

Contact: [www.ia.omron.com](http://www.ia.omron.com)

**Regional Headquarters**

**OMRON EUROPE B.V.**  
Sensor Business Unit  
Carl-Benz-Str. 4, D-71154 Nufringen, Germany  
Tel: (49) 7032-8111-0/Fax: (49) 7032-811-199

**OMRON ASIA PACIFIC PTE. LTD.**  
No. 438A Alexandra Road # 05-05/08 (Lobby 2),  
Alexandra Technopark,  
Singapore 119967  
Tel: (65) 6835-3011/Fax: (65) 6835-2711

**OMRON ELECTRONICS LLC**  
One Commerce Drive Schaumburg,  
IL 60173-5302 U.S.A.  
Tel: (1) 847-843-7900/Fax: (1) 847-843-7787

**OMRON (CHINA) CO., LTD.**  
Room 2211, Bank of China Tower,  
200 Yin Cheng Zhong Road,  
PuDong New Area, Shanghai, 200120, China  
Tel: (86) 21-5037-2222/Fax: (86) 21-5037-2200

Authorized Distributor:

© OMRON Corporation 2011 All Rights Reserved.  
In the interest of product improvement,  
specifications are subject to change without notice.

**CSM\_5\_1\_0617**  
Cat. No. E408-E1-01

Printed in Japan  
(0211)