

NEW

OMRON

CS/CJ/CP Series with a proven track record

# New Functions Added to CS/CJ/CP Series

**Position Control Unit with EtherCAT interface**  
CJ1W-NC□82

**Version Upgraded** in October 2015  
Electronic cam/helical interpolation control to increase the added value of machines

**Electronic cam control**



CJ1W-NC□82

**Increased security**

**CS/CJ/CP CPU Units**

**Version Upgraded** in October 2015  
More secure 16-character password protection for user programs



## Improved to meet your needs!



Enhanced lineup and functionality for more flexibility



**EtherNet/IP Unit**  
CJ1W-EIP21

**Version Upgraded** in December 2014  
EtherNet/IP bandwidth: 12,000 pps



**EtherNet/IP Coupler Unit**  
NX-EIC202

**Released** in January 2015



**EtherCAT Slave Unit**  
CJ1W-ECT21

**Released** in April 2015



**Analog Option Board**  
CP1W-ADB21/  
DAB21V/MAB221

**Version Upgraded** in January 2015  
Now mountable to CP1E



**Temperature Sensor Unit**  
CP1W-TS003/004

**Analog Input Unit**  
CP1W-AD041/AD042

**Released** in January 2015

**Analog Output Unit**  
CP1W-DA021/DA041/DA042

**Analog I/O Unit**  
CP1W-MAD11/MAD42/MAD44

realizing

# The CS/CJ/CP Series with a proven track record provide **improved and additional functionality**

Design asset protection, increase in machine performance, coping with frequent changes in specifications ... To provide the best solution for your needs, Omron has worked on the further development of the proven CS/CJ/CP Series.



## 16-character password to keep your assets secure

Version upgraded  
October 2015

The number of characters in each password for UM read protection and task read protection is increased from 8 to 16. This improves the security of your design assets.

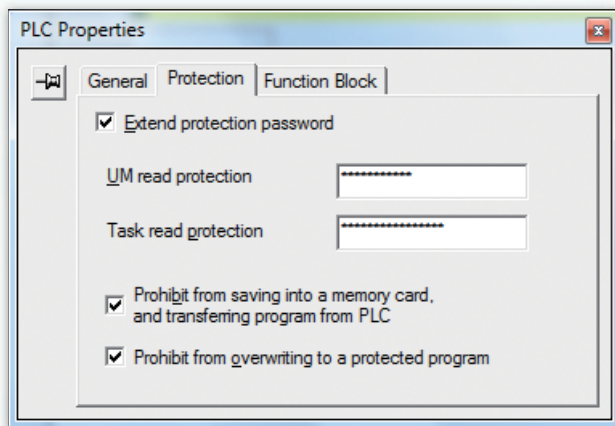

New NX EtherNet/IP Coupler Unit

## More flexible machine design

New product  
January 2015

The NX-EIC202 EtherNet/IP Coupler Unit enables a flexible distributed I/O system to be built using NX I/O in the CJ2/CS1 system. This allows you to save space and to flexibly respond to changes in machine specifications.

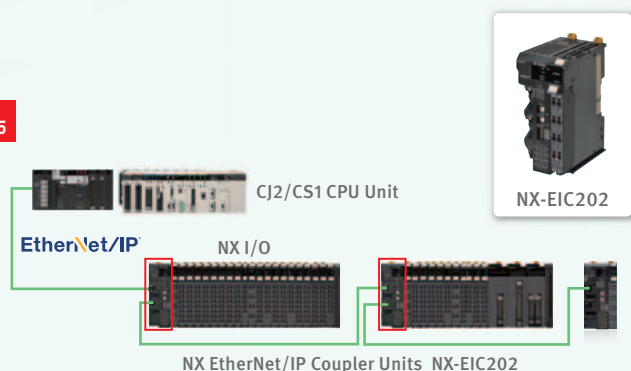

Increased EtherNet/IP bandwidth to 12,000 pps

## Improving production efficiency

Version upgraded  
December 2014

The EtherNet/IP bandwidth of the CS/CJ Series was increased from 6,000 pps to 12,000 pps. Improved communications performance will reduce the communications cycle time, resulting in a reduction in production cycle time. EtherNet/IP networks can be combined into a single topology, which means the network configuration is simplified.



# CJ

Upgraded CJ1W-NC□82 Position Control Unit with EtherCAT interface

## Electronic cam synchronization to increase machine accuracy

Version upgraded  
October 2015

The CJ1W-NC□82 Position Control Unit with EtherCAT interface now provides the electronic cam/helical interpolation functionality. Multi-axes synchronous control increases the speed and accuracy of your machine, leading to a shorter cycle time.

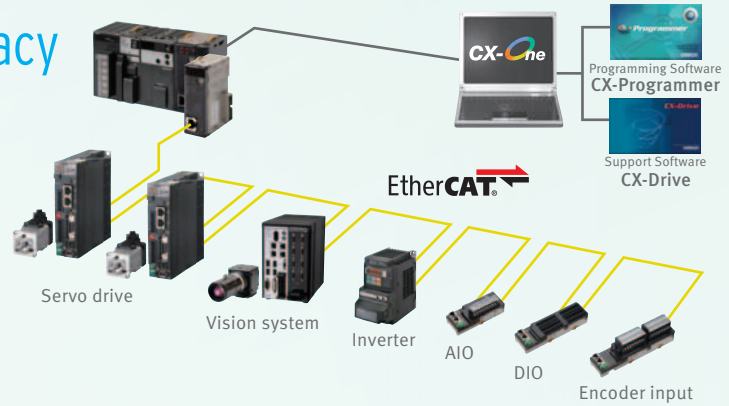

CJ1W-NC□82

New EtherCAT Slave Unit for CJ/NJ Series

## Distributed control for easy design and installation

New product  
April 2015

The CJ1W-ECT21 EtherCAT Slave Unit enables high-speed I/O link based on EtherCAT and distributed control using multiple controllers. The modularized system facilitates the design and installation of machines.

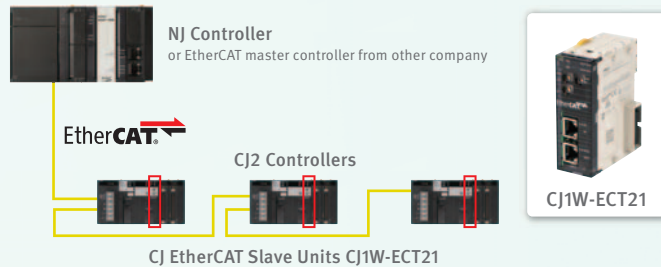

CJ1W-ECT21

# CP

## More scalable

The unit with multiple analog I/O or with multiple temperature sensor inputs provides more scalability and flexibility. Up to three expansion units can be added.

New product  
January 2015

Applications: Molding machines, ovens

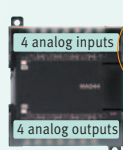

CP1W-MAD44

Up to 24 I/O can be added

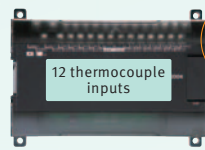

CP1W-TS004

Up to 36 inputs can be added

## High resolution to improve control/inspection accuracy

The CP1W-AD04□/CP1W-DA0□□/CP1W-MAD□□ Analog I/O Units provide high-accuracy analog I/O control with a resolution of 1/12,000.

New product  
January 2015

Applications: Inspection machines, tension control

Previous model  
(Resolution: 1/6,000)

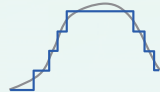

New model  
(Resolution: 1/12,000)

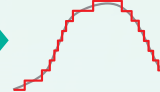

Twice higher resolution



## Flexible multi-inputs: thermocouple/analog inputs

The CP1W-TS003 has two inputs that can be used for temperature sensor or analog inputs. Both temperature sensor and analog inputs can be achieved with only one Unit.

New product  
January 2015

Applications: Vacuum packaging machines, sterilization equipment

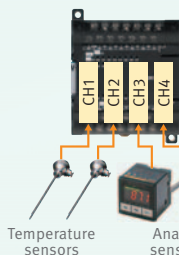

CP1W-TS003

- CH1: Temperature sensor input
- CH2: Temperature sensor input
- CH3: Temperature sensor/analog input
- CH4: Temperature sensor/analog input

## Saving space

The add-on board offers more scalability without using space in the control panel. Flexibly handle even small-scale systems.

Version upgraded  
January 2015

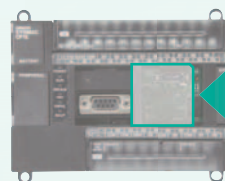

Analog Option Board  
CP1W-ADB21/  
DAB21V/MAB221

## New Functions and Versions

Function	Model	Unit version	Software version
Extended UM read password protection (16 characters) *1	CJ2M-CPU□□	Version 2.1 or later	CX-Programmer Version 9.60 or higher *2
	CJ2H-CPU□□ (-EIP)	Version 1.5 or later	
	CJ1G-CPU□□P	Version 4.1 or later	
	CS1G-CPU□□H	Version 4.1 or later	
	CS1H-CPU□□H	Version 4.1 or later	
	CS1D-CPU□□H	Version 1.4 or later	
	CS1D-CPU□□P	Version 1.4 or later	
	CS1D-CPU□□S	Version 2.1 or later	
	CP1L- (E) M/L	Version 1.1 or later	
	CP1H-X (A) /Y	Version 1.3 or later	
	CP1E (All models)	Version 1.3 or later *3	
Increased EtherNet/IP bandwidth to 12,000 pps	CJ1W-EIP21	Version 3.0 or later	Network Configurator Version 3.57 or higher
	CS1W-EIP21	Version 3.0 or later	
	CJ2H-CPU□□-EIP (Built-in port)	Version 3.0 or later (EtherNet/IP Unit)	

\*1 When using an extended password, use the CPU Unit and CX-Programmer that support extended passwords.

\*2 Implement the CX-One auto-update in October 2015 or later.

\*3 Shipment of the CP1E version 1.3 will commence in January 2016.

## Connectable CPU Units and Support Software

Product name and model	Unit version	Connectable Unit	Unit version	Software version
EtherCAT Slave Unit CJ1W-ECT21	Version 1.00	CJ-series CPU Units	All versions	CX-Programmer Version 9.54 or higher
		CP-series CPU Units		
EtherNet/IP Coupler Unit NX-EIC202	Version 1.00	CJ1W-EIP21	All versions	Network Configurator Version 3.57 or higher
		CS1W-EIP21		
		CJ2H-CPU□□-EIP (Built-in port)		
		CJ2M-CPU3□ (Built-in port)		
Position Control Unit with EtherCAT interface CJ1W-NC□82	Version 1.50 or later	CJ-series CPU Units	All versions	CX-Programmer Version 9.62 or higher
Temperature Sensor Unit CP1W-TS003 (Multi-inputs) CP1W-TS004 (12 inputs)	—	CP1□ CPU Units	All versions	Not specified
Analog I/O Unit (High resolution) CP1W-AD042 CP1W-DA042 CP1W-MAD□2	—	CP1□ CPU Units	All versions	Not specified
Analog Option Board CP1W-ADB21 (Input) CP1W-DAB21V (Output) CP1W-MAB221 (I/O)	—	CP1E-N30/40/60D□-□ CP1E-NA20D□-□	Version 1.2 or later	Not specified
		CP1L-EM/EL	All versions	Not specified

Microsoft product screen shot(s) reprinted with permission from Microsoft Corporation.

EtherCAT® is registered trademark and patented technology, licensed by Beckhoff Automation GmbH, Germany.

EtherNet/IP™ is a trademark of ODVA.

Other company names and product names in this document are the trademarks or registered trademarks of their respective companies.

Note: Do not use this document to operate the Unit.

**OMRON Corporation** Industrial Automation Company  
Tokyo, JAPAN

Contact: [www.ia.omron.com](http://www.ia.omron.com)

### Regional Headquarters

#### OMRON EUROPE B.V.

Wegalaan 67-69, 2132 JD Hoofddorp  
The Netherlands  
Tel: (31)2356-81-300/Fax: (31)2356-81-388

#### OMRON ELECTRONICS LLC

2895 Greenspoint Parkway, Suite 200  
Hoffman Estates, IL 60169 U.S.A  
Tel: (1) 847-843-7900/Fax: (1) 847-843-7787

#### OMRON ASIA PACIFIC PTE. LTD.

No. 438A Alexandra Road # 05-05/08 (Lobby 2),  
Alexandra Technopark,  
Singapore 119967  
Tel: (65) 6835-3011/Fax: (65) 6835-2711

#### OMRON (CHINA) CO., LTD.

Room 2211, Bank of China Tower,  
200 Yin Cheng Zhong Road,  
PuDong New Area, Shanghai, 200120, China  
Tel: (86) 21-5037-2222/Fax: (86) 21-5037-2200

Authorized Distributor:

© OMRON Corporation 2015 All Rights Reserved.  
In the interest of product improvement,  
specifications are subject to change without notice.

Cat. No. P097-E1-01

0915 (0915)