

CS/CJ-series High-speed Data Storage Units
Storage and Processing Units

SPU Unit

CS1W-SPU01/02-V2
CJ1W-SPU01-V2

SPU Unit Setting Software

SPU-Console

WS02-SPTC1-V2

SPU Unit-Host Data Link Software

Data Management Middleware

WS02-EDMC1-V2

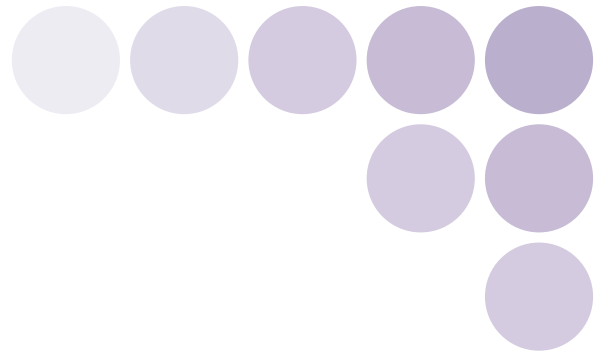

Automatic transfer of CSV files
collected in the SPU Unit

Data Management
Middleware (EDMS)

PLC data collected and saved
as CSV files

SPU Unit

The **SPU Unit** reads PLC I/O memory according to specified collection methods and stores the data in CSV (Comma Separated Value) files with time stamps. The SPU Unit can record a variety of data from equipment using a PLC.



CS1W-SPU01/02-V2



CJ1W-SPU01-V2

Use the **SPU Unit** to record data such as production history data, inspection data, and process data. Electronically managing data on the operation of equipment and devices enables root cause analysis when errors occur, as well as a proper understanding of operational tendencies.

SPU Unit

CS1W-SPU01/02-V2
CJ1W-SPU01-V2

Data Collection Using a PLC Unit

- PLC data is collected in a PLC Unit with superior environmental resistance without using a computer.

CS1W-SPU01/02-V2

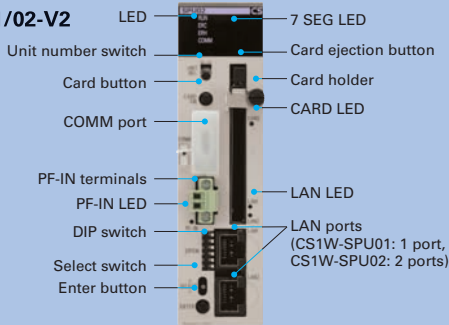

- Until now, data has been collected in PLC memory. Using an SPU Unit, however, eliminates the need for a PLC with a large-capacity memory and also eliminates the need for programming data collection in the ladder program.

CJ1W-SPU01-V2

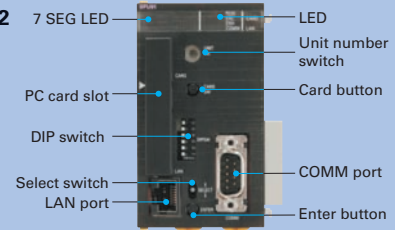

Fast Collection of Large Amounts of Data with Data Concurrency

- Using a computer for data collection presents the problems of a slow collection speed and low collection-point capacity. An SPU Unit enables high-speed collection of large amounts of data*.
- Direct use of the PLC bus instead of communications via a serial connection or LAN enables large amounts of data to be collected at a high speed.
- Some data collection devices from other companies may not provide data concurrency. The SPU Unit, however, provides concurrency of simultaneous data.

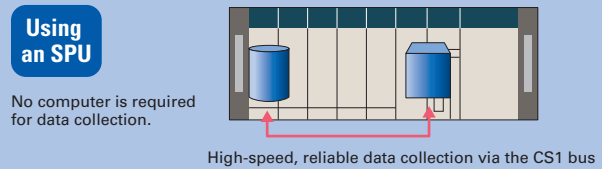
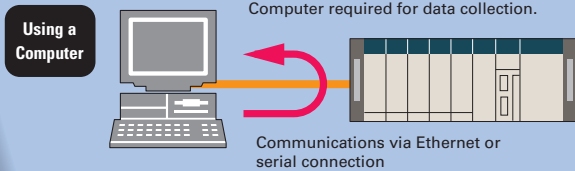

* The maximum total size of all variables is 7,776 words. For details, refer to "CS1W-SPU01/SPU02-V2, CJ1W-SPU01-V2 SPU Units Operation Manual"(Cat. No. V236).

No Ladder Programming

- No ladder programming is required for data collection. Data can be collected simply by performing the settings from the setting software (i.e., SPU-Console).
- No need to leave extra space in the PLC memory for saving data.

Note: The PLC cycle time increases in proportion to the number of points collected.

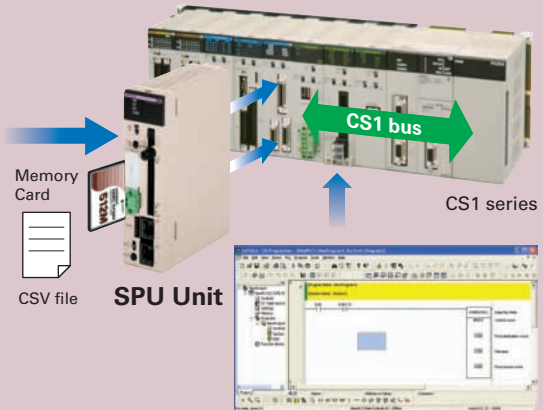
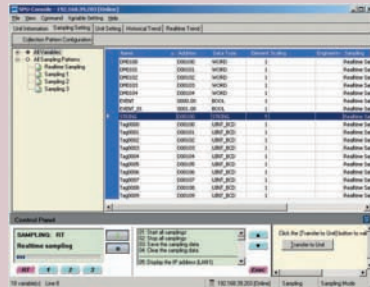

Restriction-free Data Configuration Files without Depending on PLC Memory Space

- Files can be created with the desired data configuration for only the necessary data from PLC memory.
- The data to be collected can be stored in files in the required data type, such as BOOL, REAL, INT, BCD, or STRING.
- Data configuration files required for the host computer can be created, so necessary data can be retrieved even if the SPU is mounted in a device after the PLC is already set up.
- CHANNEL_BLOCK has been added to the variable data types from SPU Unit version 2.0. When the data type is set to CHANNEL_BLOCK, the data in a consecutive memory area starting from the specified address for the specified number of elements is handled as a single data item with no commas.

PC(Windows)

Microsoft Excel - P3sita.csv

A1	B	C	D	E	F	G	H	I	J	K	
index	clocktime	nano	SampleIn	X-Position	Y-Position	X-Position	CarryingIn	Numbers	Tag-001	Sin	
1	1	14:41:1	1.08E+08	0	1	0	1	119	1089	13056	0.890211
2	2	14:41:1	1.13E+08	1	0	0	1	125	1069	39271	0.891005
3	3	14:41:1	1.18E+08	2	1	0	1	130	1069	65496	0.891796
4	4	14:41:1	1.23E+08	3	0	1	0	136	1089	26163	0.891796
5	5	14:41:1	1.26E+08	4	1	1	0	142	1069	52377	0.892504
6	6	14:41:1	1.33E+08	5	0	1	0	148	1069	13055	0.89337

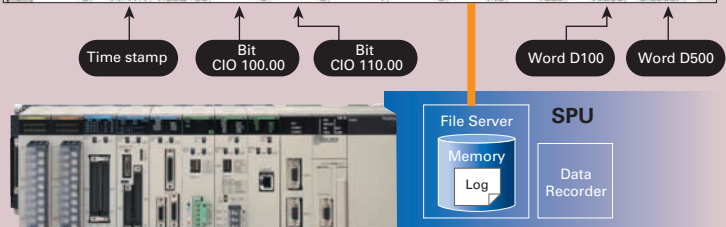

Windows is a registered trademark of Microsoft Corporation in the United States and other countries. Microsoft product screen shots reprinted with permission from Microsoft Corporation.

Other company names and product names in this document are the trademarks or registered trademarks of their respective companies.

Functions

Using FTP to Send Collected Data (Unit Version 2.1 or Later)

- With unit version 2.1 of the SPU Unit, collected data can be sent to the host computer using FTP.
- There is no need to create a data collection application on the host computer. (All that is required on the computer is an FTP server.)
- SPU-Console version 2.1 is used to set up the FTP server at the send destination. There is no need for special ladder programming in the PLC.
- The loads on the host computer and network are reduced.

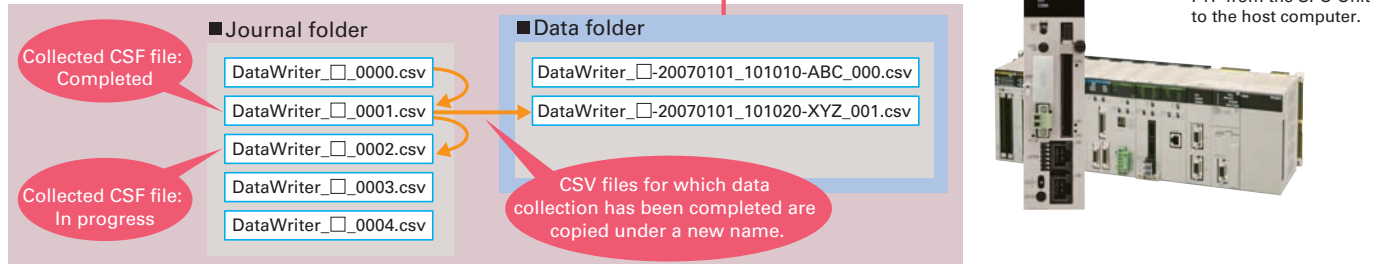

Data Connectivity with the Computer

- The collected data can be loaded onto a computer via a PC card or Ethernet.
- FTP can be used to transfer data between the SPU Unit and the computer. (SPU Units with unit version 2.1 or later can function as an FTP client.)
- Data can be loaded onto the host computer with simple settings by using the Data Management Middleware software (refer to p. 10).
- Using shared folders, data files collected in the SPU Unit can be accessed from a LAN-connected Windows computer just as if accessing files on the computer itself.

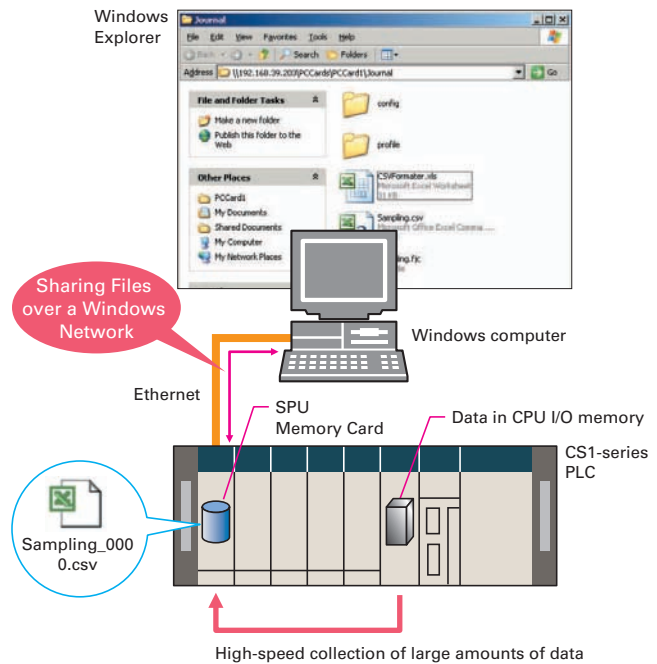
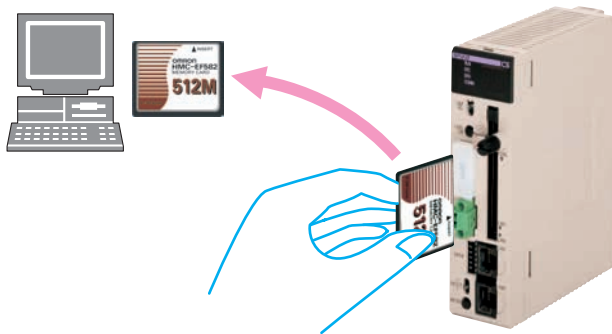

Collection Methods to Match the Application

Depending on the application, the Data Storage Mode can be used to collect data at a specific time or when there is a change in data, and the Sampling Mode can be used to accurately collect data at high speed. The Data Storage Mode enables establishing a system for error monitoring and production management for each lot or value by recording snapshots of data during production and when errors occur.

Note: The Sampling Mode and Data Storage Mode cannot be used at the same time.

Sampling Mode

- In this mode, I/O memory data for the PLC is sampled at a constant time interval. Data can be faithfully reproduced from the collected data.

Data Storage Mode

- In this mode, the specified PLC I/O memory can be recorded when triggered by a specific event. The mode can be used to record data when a specified bit turns ON or at a specified time. Data can also continue being recorded at a constant time interval after an event occurs. This enables establishing a system for error monitoring and production management for each lot and value by recording snapshots of data during production or when errors occur.

Note: The time interval is less precise than the interval in Sampling Mode.

Event-triggered Collection Patterns

The patterns include memory events, which occur when a memory value matches a specified condition, and scheduled events, which occur at a specified time or time

interval. The occurrence of these events can be used to implement rules, such as those for starting and stopping data collection. (Applicable only in Data Storage Mode.)

Memory Events

- Memory events can be set to generate an event when a change occurs in I/O data in PLC memory. Using memory events, events can be generated for a change in a bit ON/OFF status or by comparison to a set value (i.e., equal, above, below, or within range). For example, data could be collected only once when bit A turns ON. Alternatively,

an event rule could be defined to start collection when bit A turns ON and stop collection when bit B turns ON.

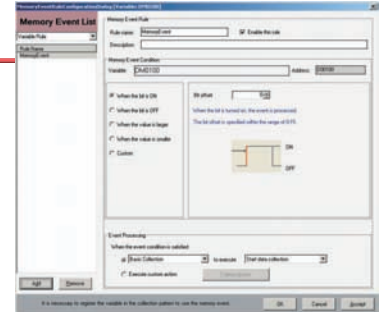

Scheduled Events

- Scheduled events can be set to generate an event at a specific date and time using Scheduler settings.
- Event rules can be defined with Scheduler settings for collecting data as a result of events specified, for example, by the hour (e.g., every hour), day (e.g., every day), or week (e.g., every Monday). It is also possible to specify events by operating days or for the end of the month.

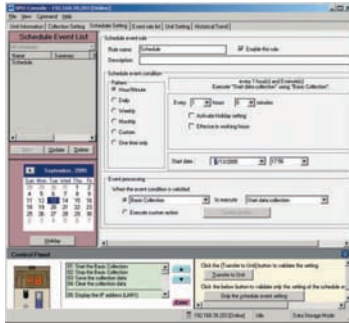

Pattern	Settings
Hours/minutes	Select to generate the scheduled event at an interval specified in units of hours and minutes.
Days	Select to generate the scheduled event at an interval specified in days.
Weeks	Select to generate the scheduled event at an interval specified in units of weeks.
Months	Select to generate the scheduled event at an interval specified in units of months.
User defined	Select to generate the scheduled event at a user-defined interval.
Once only	Select to start the scheduled event once only.



Actions

Start copying	Data collection is started.
Stop copying	Data collection is stopped
Acquisition of data (one-shot)	Records data once only when the condition is satisfied.
Switch files	The next file is switched to if data is being stored in multiple files.

Collection Settings Changeable during PLC Operation

- Collection settings can be changed and collection can be restarted without turning OFF the PLC.
- Required data can be added and the collection interval can be changed even while the system is operating. Installing an SPU enables adding various systems after the system is already in operation.

Note: The PLC cycle time increases in proportion to the number of points collected.



- Change collection settings.
- Restart collection.
- Add data.
- Change the collection interval.

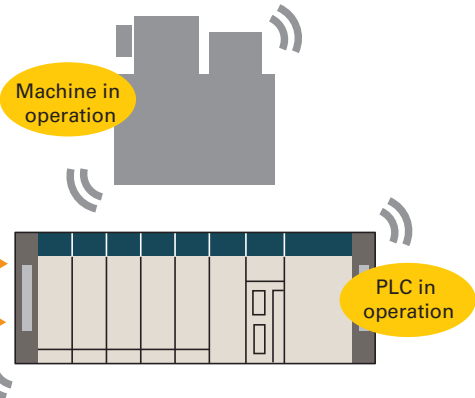

These functions enable the following applications simply by making settings.

The movement end position and filling pressure are recorded for each workpiece at events generated for starting and stopping filling.

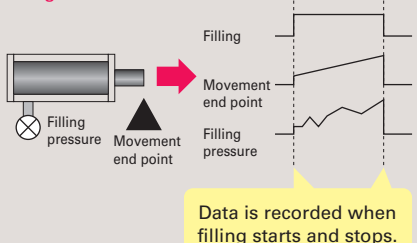

Process data for each wafer can be recorded from receiving the wafer until completion.

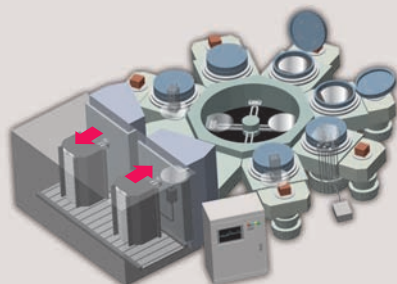

During the testing, process data can be recorded for each product from the start of tests until completion.

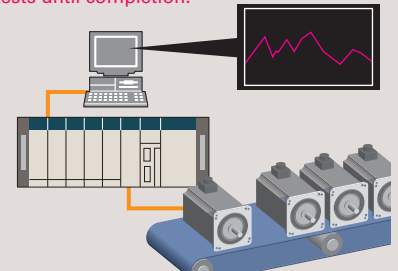

Functions

Collection as Fast as 5 ms

Data can be collected at up to 5 ms for realtime sampling in Sampling Mode.

Collection Interval Examples (Maximum Performance)

- 25 data items (variables): 5 ms
- 250 data items (variables): 10 ms
- 500 data items (variables): 20 ms

Note: These times may not be possible for some settings.

Conventional Collection with a Computer at an Interval of Hundreds of Milliseconds

Collection with an SPU Unit at an Interval of a Few Milliseconds

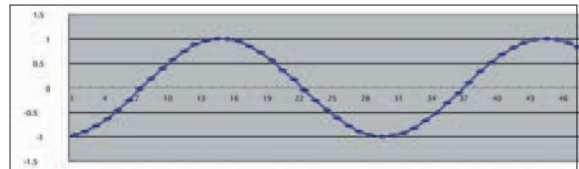
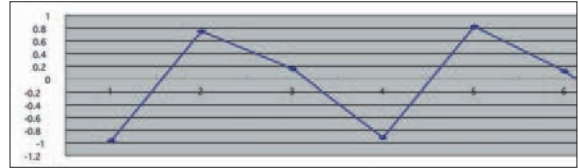

Recipe Function

- The recipe function enables writing numeric data (such as production parameters) and text strings to a memory area of the PLC. Using the recipe-writing function simplifies tasks such as retooling.

(**Note:** The recipe function can be used only in Data Storage Mode.)

* Numeric data and text strings to be written to a memory area of the PLC must be created in advance as recipe data (i.e., a CSV file) and stored in a Memory Card in the SPU Unit.

- Ladder programming for developing recipe data is not required.
- Using the recipe function saves PLC memory by saving recipe data to a Memory Card in the SPU Unit rather than requiring saving to the PLC data memory.
- Recipe data can be written in response to a request from the PLC or from a computer or other external device.
- Numeric data and text strings can be changed even when the SPU Unit is operating.

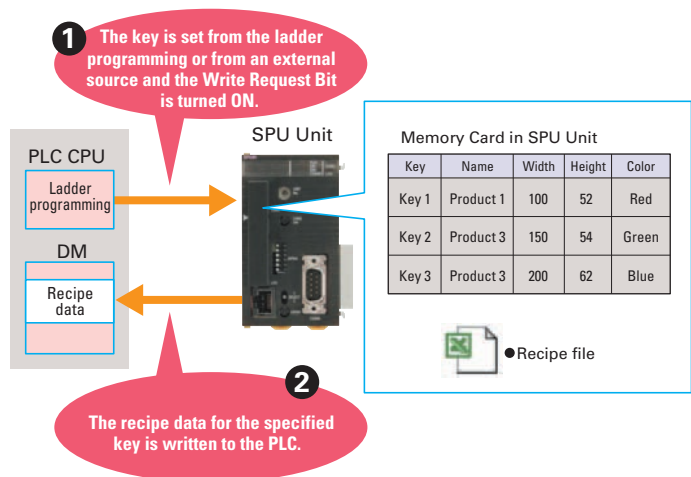

Using FTP to Receive Recipe Files (Unit Version 2.1 or Later)

- Once you set up a Request Bit in the PLC with the SPU-Console Setup, all you have to do is turn ON the bit for the SPU Unit to function as an FTP client and receive a recipe file from the FTP server.
- A recipe file can be automatically received from the host computer (functioning as the FTP server) simply by turning ON an input to the PLC.
- You can combine the recipe function with a PT to create an application in which production parameters can be downloaded to equipment simply by pressing a button on the PT.

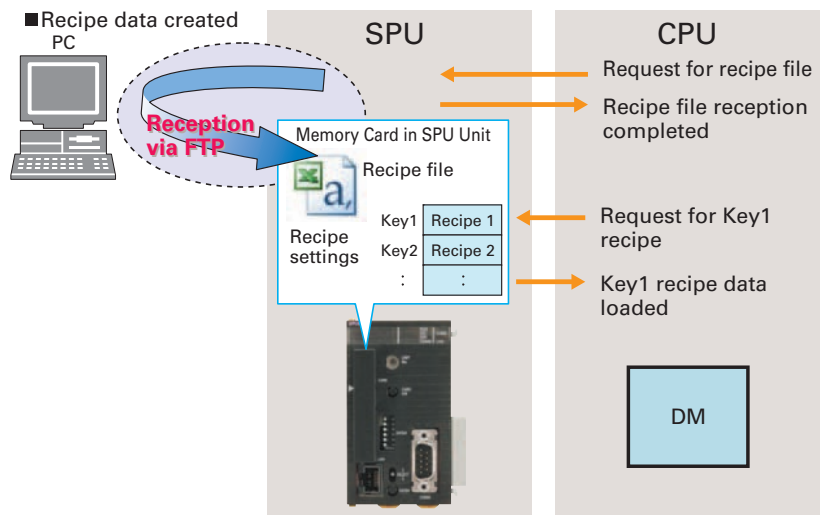

Setting Software That Is Easier To Use than Ever Before

- Project Explorer**
 SPU Unit connection destinations can be managed using the SPU-Console. SPU Unit settings can be saved as projects, edited, and managed. For example, a project that has been previously set can be copied and easily reused.
- Data Collection Status Display and Error Log Display**
 The SPU Unit's operating status and error information can be displayed on the SPU-Console. A list can be displayed showing the status of data being collected, current errors, or error log. For example, the total time required to collect data and the total size of data collection files can be displayed.
- Importing and Exporting Variable Definitions Using CSV Files**
 All variable definitions can be exported to CSV files. Variable definitions can then be edited using software such as spreadsheets. Also, data on units and scaling, for example, can be batch-edited using a spreadsheet and imported to the SPU-Console.
- Unit Setup Using the CX-programmer**
 Unit setup for SPU Unit can be performed from CX-One version 2.1. IP addresses can be set from the CX-Programmer.

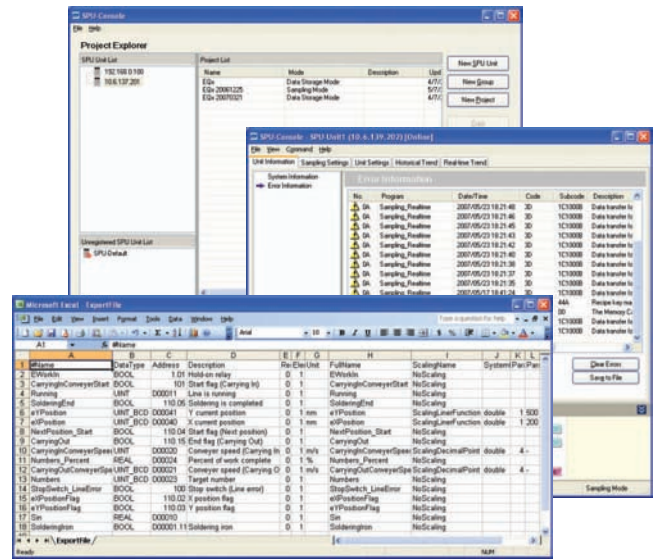

Report Function

- The report function is used to display in Microsoft Excel a CSV file that was collected by the SPU Unit. This is different from simply opening the CSV file in Excel. Variable data collected by the SPU Unit can be displayed in any specified cells.
- The report function can be used to easily create reports, such as daily reports, from CSV files collected by the SPU Unit. Sample templates, such as daily manufacturing reports and error logs, are provided to make it easier to create various kinds of reports.

■ CSV File

index	obctime	nano	SampleIndx	Tag0000	Tag0001	Tag0002	Tag0003
0	53.08.8	7.57E+08	1	391.72	391.72	581.33	1823
1	53.08.8	7.64E+08	2	391.72	391.72	581.33	1823
2	53.08.8	7.75E+08	3	391.72	391.72	581.33	1823
3	53.08.8	7.8E+08	4	391.72	391.72	581.33	1823
4	53.08.8	8.05E+08	5	391.72	391.72	581.33	1823
5	53.08.8	8.17E+08	6	391.72	391.72	581.33	1823
6	53.08.8	8.31E+08	7	391.72	391.72	581.33	1823

■ Display in Excel

Specified variable data is displayed in a specified cell.

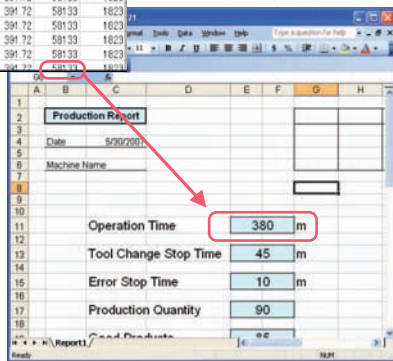

■ CSV File

index	obctime	nano	SampleIndx	Tag0000	Tag0001	Tag0002	Tag0003
0	53.08.8	7.57E+08	1	391.72	391.72	581.33	1823
1	53.08.8	7.64E+08	2	391.72	391.72	581.33	1823
2	53.08.8	7.75E+08	3	391.72	391.72	581.33	1823
3	53.08.8	7.8E+08	4	391.72	391.72	581.33	1823
4	53.08.8	8.05E+08	5	391.72	391.72	581.33	1823
5	53.08.8	8.17E+08	6	391.72	391.72	581.33	1823
6	53.08.8	8.31E+08	7	391.72	391.72	581.33	1823

■ Display in Excel

Specified variable data is displayed in specified cells as history data.

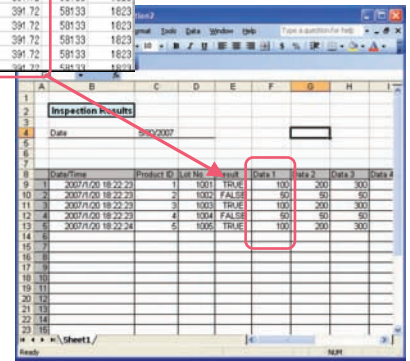

Item		Specification
Model number		WS02-SPT1-V2 (SPU-Console Ver.2.2)
System requirements	Computer hardware	Computer that meets the system requirements for Microsoft Windows
	Display	Super VGA (800 x 600) or better high-resolution video adapter and monitor
	OS	Microsoft Windows XP Home Edition / Professional Microsoft Windows Vista Microsoft Windows 7 (32bit/64bit) Microsoft Windows 8 (32bit/64bit)
	Application platform	Microsoft.NET Framework Version 1.1 Microsoft.NET Framework Version 2.0
Communications platform FinsGateway Version		FinsGateway Version 2003

Examples

Semiconductor Manufacturing Equipment and Facilities

◆ Advantages of Data Collection for Equipment and Facilities

Reduced development and startup time

Startup time is reduced by early extraction of the optimal process conditions for overall equipment and individual parts during equipment development or startup.

Improved throughput

Based on the data, the operation causing bottlenecks can be found and improved, which will lead to improvements in throughput.

Improved operating rates by minimizing differences between machines

The operating rate can be improved by collecting data for each device and performing combinations to find the points of machine variations.

Minimized downtime

Fast recovery can be achieved based on the data when there are product (i.e., wafer) faults by analyzing the causes in the process of entire devices and individual device parts or in machine operation.

Preventive maintenance

The condition of equipment and facilities can be understood to effectively use spare parts at the optimal time.

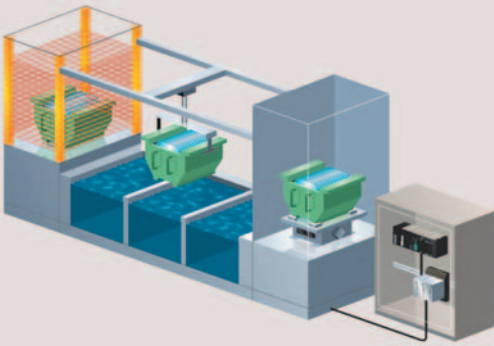

◆ Features of a System Using the SPU Unit

- Data or bit signals can be read from devices (e.g., MFC or RF power supplies) in equipment via DeviceNet or using a PLC Unit to reliably collect data at high speed with an SPU Unit. Making the required settings is simple.
- Data format can be created freely for the collection data taking into account the link with the host.
- The collection interval can be set freely according to the device or part for collection.
- One file can be made of data collection starting when the chamber is entered and stopping when the chamber is exited.
- The collected data is transferred to the host for each wafer process and each lot.
- The file name can be set to the collection time or device name when it is transferred.

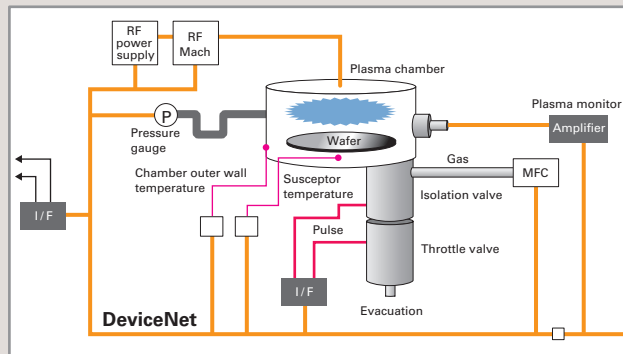
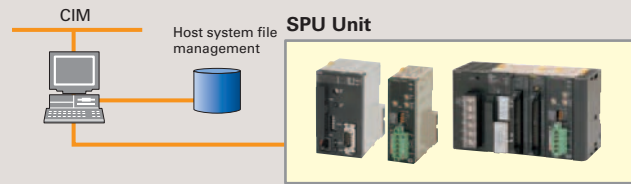

Auto Parts Production Line

◆ Benefits of Data Collection for Equipment and Facilities

Reduced startup time

Reduce startup time by quickly finding differences during startup in the operation of entire facilities and individual machines compared with during development.

Reduce production time per unit

Based on the data, the operations causing bottlenecks can be found and improved, which will lead to improvements in the production time per unit.

Improved operating rates by minimizing differences between machines

The operating rate can be improved by collecting data for each device and performing combinations to find the points of machine variations.

Minimized downtime

Quick recovery can be achieved by analyzing causes based on the equipment data when an error occurs.

Preventive maintenance

The condition of equipment and facilities can be understood to effectively use spare parts at the optimal time.

◆ Features of a System Using the SPU Unit

- Data can be collected from equipment controlled by a PLC without restrictions.
- Collection data can be formatted without restrictions.
- Collection intervals can be set freely according to the device or part for collection.
- One file can be made of data collection starting and stopping according to machine timing.
- Data can be transferred to the host system without turning OFF the PLC controlling the system.
- Settings for the items to be collected can also be changed without turning OFF the PLC.

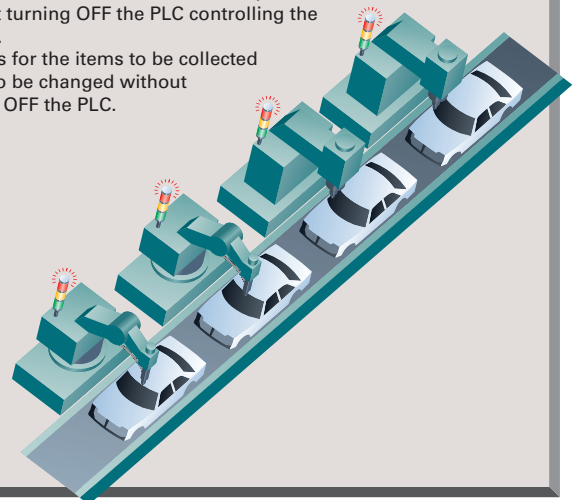

Sampling Examples

- Monitor the deterioration of an actuator (e.g., monitoring the time from the starting edge to the stopping edge).
- Monitor interlocks between robots (e.g., the interlock signal times)
- Monitor motor deterioration trends (e.g., monitoring the ON time, revolutions, and speed).

Data Measurement Applications

◆ Application Examples

- Factory data on temperatures, electric power, and pressure can be collected and stored without a computer.
- Production history data can be collected easily and applied for traceability and root cause analysis.
- Inspection process data can be collected easily and applied for traceability.
- Collection and storage of process data at device startup enable stabilization of process conditions in the device and maintenance of product quality.

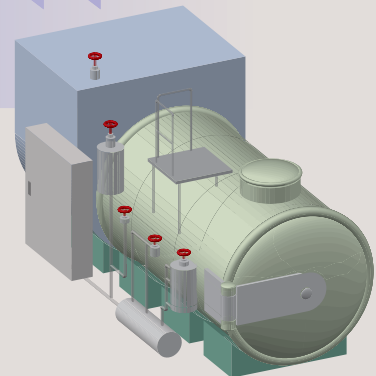
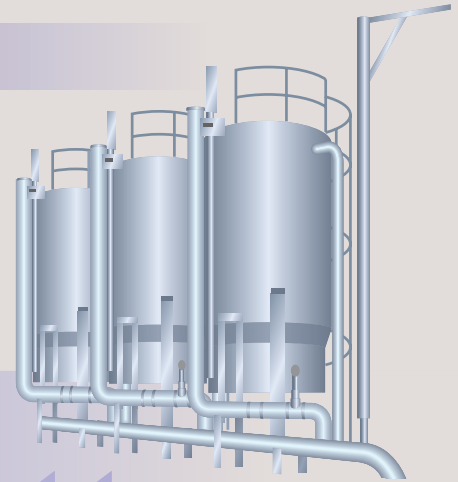

Benefits of SPU Introduction

- Relief from anxiety over data collection using a computer
- Collecting large amounts of data at a high speed
- Eliminating development costs for data collection software
- High-speed collection

Applications for Facility Improvement, Troubleshooting, and Preventive Maintenance

◆ Application Examples

- Electronic management of data on operation of machines and facilities enables precise measurement for improvement of the production time per unit without using a conventional stopwatch.
- Electronic management of data on operation of machines and facilities enables troubleshooting based on data rather than the conventional reliance on experience or intuition. Even non-expert employees can perform troubleshooting to minimize downtime.
- The efficiency of preventive measures can be improved for remote machines by transferring operation data and enabling prediction of causes.
- Electronic management of data on operation of machines and facilities enables understanding of equipment trends and assists in preventive maintenance.

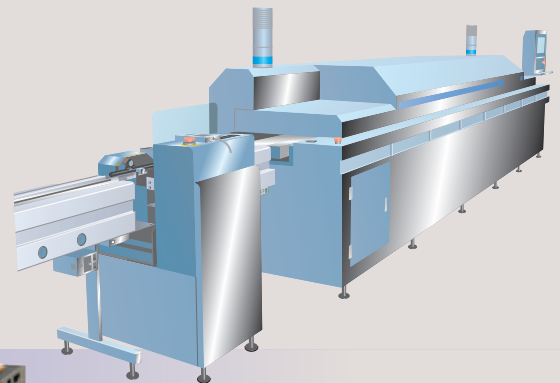

Benefits of SPU Introduction

- Collect data at the same interval as the PLC cycle time
- Collecting large amounts of data at a high speed
- Eliminating development costs for data collection software
- Electronic management of data on operation of devices for analysis and understanding of trends

Data Management Middleware

Data Management Middleware for the SYSMAC SPU

- The Data Management Middleware for the SPU Unit is Windows-based software for transferring data files collected by the SPU Unit to the computer and managing the files.
- The CSV files can be transferred to a computer by setting only the CSV files the user wants to transfer. It is not necessary to install or set up FTP server software on the computer.
- The data collected by the SPU Unit is automatically stored in an untitled table as a database. It isn't necessary to create a program to store data to the database, reducing the cost of system development. (This is a new version-2 function.)

- The user can select a name and folder when copying the data files to the computer. Files can be copied with easily distinguished names, for example, by adding the collection date and time to a chosen character string such as "Device1."
- The SPU Unit will continue recording data even if the computer is turned OFF because of a network interruption or other cause.
- Copying can be resumed from a data file if it is not already transferred. Data collection systems can therefore be established with strong resistance against system disturbances.
- The SPU Unit time and CPU Unit time can be periodically set to the computer time automatically.

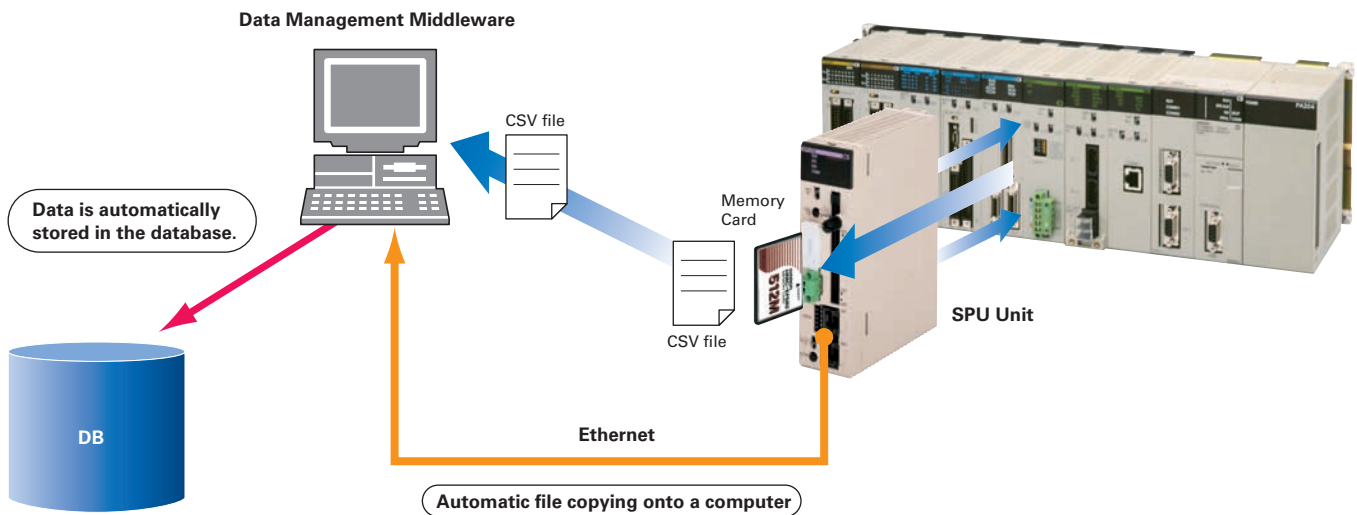

Item	Specification	
Model	WS02-EDMC1-V2	
System requirements	Computer	Personal computer with a Pentium, Celeron, or equivalent processor
	Display	SVGA (800 x 600) or better high-resolution video adapter and monitor
	OS	Microsoft Windows 8 (32bit/64bit) Microsoft Windows 7 (32bit/64bit) Microsoft Windows Vista Microsoft Windows XP Professional Microsoft Windows XP Home Edition Microsoft Windows Server 2012 Microsoft Windows Server 2008 Microsoft Windows Server 2003
	Platform (execution environment)	Microsoft NET Framework Version 1.1 Microsoft Data Access Components (MDAC) 2.6 or higher
Communications platform	FinsGateway Version2003	
Other required software	The separate SPU-Console is required to make SPU Unit settings.	
Copy functions	Number of copies	Up to 256 copies can be set.
	Initial start condition	Automatic startup when computer starts or use Start Button.
	Storage location	Any folder
	Storage file name	The file name can be created automatically by combining the following string formats: Any user-set string, copied name, copy-source Unit name, copy date (year, month, day) and time, copied file's serial number, date/time of the first record in the file, or date/time of the last
Database storage functions	Number of stored databases	Up to 65 databases can be set.
	Initial start condition	Automatic startup when computer starts or use Start Button.
	Applicable database formats	Microsoft Access, Microsoft SQL Server, Oracle Database

General Specifications

Item		Specification	
Applicable PLCs		CS Series	CJ Series
Unit model number		CS1W-SPU01/02-V2	CJ1W-SPU01-V2
Unit classification			
CPU Bus Unit			
Unit number		0 to F	
Mounting location		16 Unit max. (See note 1.)	
No. of Units per PLC		CPU Backplane or CS-series Expansion Backplane (Cannot be mounted to C200H Expansion I/O Rack or SYSMAC BUS Remote I/O Slave Rack.)	CPU Rack or Expansion Rack
Interfaces	PC card slot	PC card Type II, 1 slot (Conforms to PC Card Standard Release 8.0.) Used by mounting Memory Card (see note 2.) and Memory Card Adapter (see note 3.).	CF Card Type I/II, 1 slot (Conforms to Compact Flash Specification Revision 1.4.)
	LAN ports	CS1W-SPU01: One port (10/100Base-TX) CS1W-SPU02: Two ports (10/100Base-TX)	One port (10/100Base-TX)
	UPS power interruption input	Connect the power interruption signal output line from the UPS.	—
	Serial port	(For future expansion)	Connection to a UPS for power interruption notification
Settings and operation	Unit number switch (UNIT)	Rotary switch: Sets the unit number of the Unit as a CPU Bus Unit.	
	Select switch (SELECT)	Toggle switch: Sets the number of the command to execute.	
	Enter button (ENTER)	Pushbutton switch: Confirms and starts execution of the command number set using the select switch.	
	DIP switch (DIPSW)	DIP switch: System settings	
Card button	Pushbutton switch: Pressed to remove the Memory Card inserted in the PC card slot. Removing the Memory Card will be enabled.		
Indications	LED	RUN, ERC, ERH, COMM, LAN1, LAN2, CARD, PF-IN	RUN, ERC, ERH, COMM, LAN, CARD
	7-segment display	<ul style="list-style-type: none"> Displays error information and operating status of the SPU Unit. Displays the command number set on the select switch. Displays the IP address. 	
Approved standards		UL508/UL1604 and EC Directives	

Note 1: Heed the precautions for current consumption for each device.
Note 2: Memory Card (OMRON HMC-EF□□□)
Note 3: Memory Card Adaptor (OMRON HMC-AP001)

Standard Models

Model	Name	Specification
CS1W-SPU01-V2	SPU Main Unit (Ver. 2.2) for the CS Series	One LAN port, PC card slot
CS1W-SPU02-V2	SPU Main Unit (Ver. 2.2) for the CS Series	Two LAN ports, one PC card slot
CJ1W-SPU01-V2	SPU Main Unit (Ver. 2.2) for the CJ Series	One LAN port, CF Card slot
WS02-SPTC1-V2	SPU-Console (Ver.2.2)	SPU Unit Setting Software
WS02-EDMC1-V2	SPU Unit Data Management Middleware (Ver. 2.1)	Optional software
WS02-EDMC1-V2L05	SPU Unit Data Management Middleware (Ver. 2.1)	Optional software, five licenses
HMC-AP001	Memory Card Adapter	Compact flash-PC card adapter
HMC-EF183	Memory Card (See note 2.)	128-MB compact flash card
HMC-EF283	Memory Card (See note 2.)	256-MB compact flash card
HMC-EF583	Memory Card (See note 2.)	512-MB compact flash card

Note 1: The Setting Software is required to set the SPU Unit.
Note 2: A Memory Card is required.
Note 3: SPU-Console versions lower than 2.0 cannot connect to SPU Units with unit versions of 2.0 or later.

Functional and Performance Specifications

Item		Specification		
Sampling	Sampling Mode	Sampling patterns	Realtime sampling: 1 pattern Normal sampling: Up to 3 patterns	
		Starting methods	Any one of the following methods can be used: <ul style="list-style-type: none"> Start automatically when SPU Unit is started. Start with an SPU-Console operation. Start with the SPU Units front-panel command buttons. (Specify the command number.) Start from the CPU Units ladder program. 	
		Interval	User-specified intervals: Realtime sampling: 5 ms min. Normal sampling: 100 ms min. Note: In both cases, the sampling cannot be performed faster than the CPU Unit's cycle time. The actual sampling interval will always be longer than the CPU Unit's cycle time even if the sampling interval is set shorter than the cycle time.	
	Data Storage Mode (Unit Ver. 1.2 or later only)	Data Collection Patterns	Basic Collection Pattern: 1 pattern (required) Data Collection Patterns: Up to 64 patterns	
		Starting methods	Basic Collection Pattern (required)	Any one of the following methods can be used: <ul style="list-style-type: none"> Start when a specified event occurs. (Use a memory event or scheduled event. For details, see the description of Data Collection Patterns.) Start automatically when SPU Unit is started. Start with an SPU-Console operation. Start with the SPU Units front-panel command buttons. (Specify the command number.) Start from the CPU Units ladder program.
			Data Collection Patterns 1 to 64	<ul style="list-style-type: none"> Either of the following methods can be used to start when an event occurs: <ul style="list-style-type: none"> Memory events: Start when a CPU Unit bit or word value matches a specified condition. Up to 500 memory events can be specified. Scheduled events: Start at a specified time or time interval. Up to 16 scheduled events can be specified.
		Interval	User-specified intervals: Basic Collection Pattern: 5 ms min. Data Collection Patterns: 100 ms min. Note 1: The Data Collection Patterns use the data collected by the Basic Collection Pattern, so the data will be collected at the Basic Collection Pattern's interval even if the Data Collection Pattern's interval is set shorter than the Basic Collection Pattern's interval. Note 2: The actual Basic Collection Pattern interval will always be longer than the CPU Unit's cycle time even if the sampling interval is set shorter than the cycle time.	
	Data Storage Mode (unit version 2.0 or later)	Copy options	Basic Collection Patterns: Setting not possible. Other Data Collection Patterns: Up to 10 patterns	
		Applicable CPU Unit I/O memory areas	CIO Area, WR Area, HR Area, AR Area, DM Area, and EM Area banks 0 to C (0 to 18: CJ2)	
	Sampling Mode and Data Storage Mode	Specifying I/O memory areas	Specify the desired CPU Unit I/O memory area (data area) with a variable. The data type can be specified with the variable. The variables can be managed in groups.	
Variable data types			BOOL, INT, UINT, DINT, UDINT, REAL, LREAL, STRING, CHANNEL, UINT_BCD, UDINT_BCD, WORD, DWORD, CHANNEL_BLOCK	
Maximum number of variables		7,776 words total for all variables		
Record Condition setting		Set whether or not to use a record condition. If a record condition is used, sampling data is stored within the SPU Unit only when the record condition is met. For example, sampling data can be recorded only while a specified bit is ON or a specified word contains a particular value (comparison).		
Data exchange with the CPU Unit		CPU Bus Unit Area <ul style="list-style-type: none"> CPU Unit to SPU Unit: Command execution (such as starting/stopping sampling, clearing a sampling file, or saving a sampling file). SPU Unit to CPU Unit: SPU Unit status information 		
Saving files		Collected data file format	CSV files	Indices (record number), time stamps (hh:mm:ss.ms), ns, sampling indices (serial numbers starting at 0 when sampling is started), data for each symbol delimited with comma, records delimited with carriage returns
	Number of sampling result records stored in one file	Record contents		
		Any one of the following methods can be used. <ul style="list-style-type: none"> The number of records can be specified. A time period can be specified. (The number of records is calculated automatically from the time period and interval between samples.) With a version 1.2 or later SPU Unit, the number of records can be left unspecified. (In this case, data is added to the file until data collection is stopped. Records are added to one file from the start of data collection until the end.) 		
	Scaling	Instead of directly storing the values collected from the CPU Unit's I/O memory, the collected values can be scaled with a linear equation or upper/lower limit range before storage (unit version 1.2 or later).		
	File size	2 GB per file		
	Record size	Specified by user.		
	Number of records	Specified by user or calculated automatically.		
Saving method	Data can be saved to a single file or multiple files (up to 1,200 files).			
Network communications	Windows network shared folders	Files in the Memory Card inserted in the PC card slot in the SPU Unit can be shared with a Windows XP, Vista, 7 or 8 computer.		
	FTP	FTP server and client provided.		
Recipe function	Data Storage Mode (unit version 2.0 or later)	FINS communications	<ul style="list-style-type: none"> FINS server to execute FINS commands Routing to transfer FINS messages 	
		Number of fields	10,000	
	Recipe files	File format: CSV The file size is restricted by the file size that can be stored in the recipe folder. Records: Specified by the user.		
	Writing method	Conversion method: Each field is written to the specified address in the specified data type. Continuous region method: Data is written to continuous memory addresses.		

■ Dimensions (mm)

CS1W-SPU01/02-V2

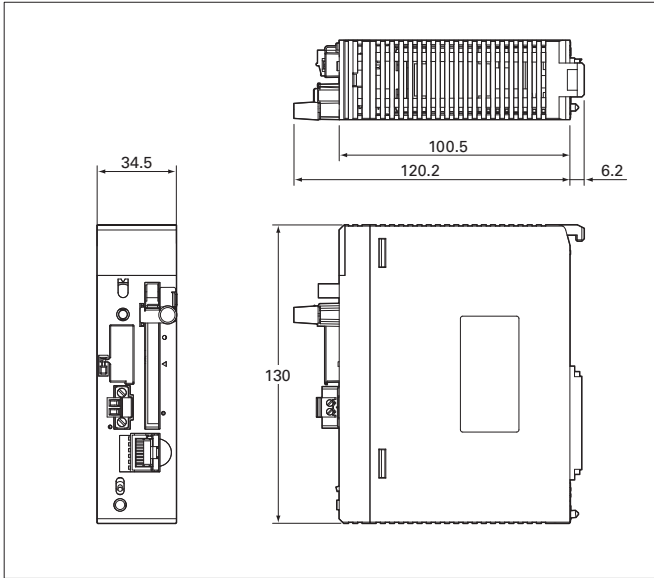

CJ1W-SPU01-V2

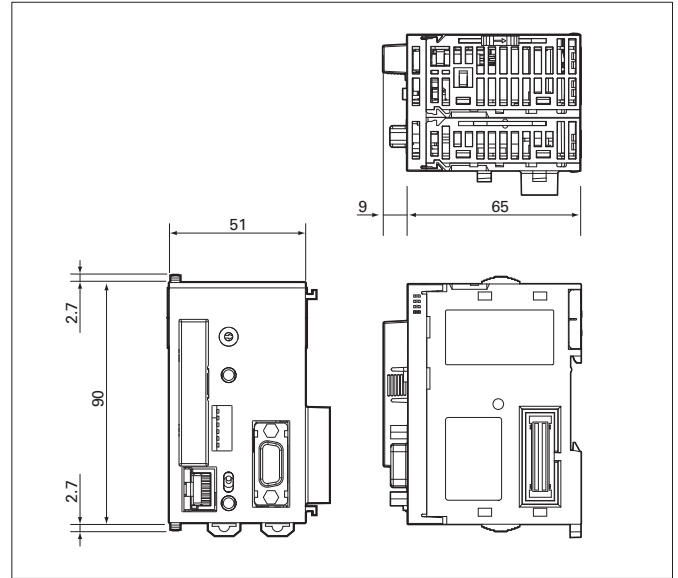

- The application examples provided in this catalog are for reference only. Check functions and safety of the equipment before use.
- Never use the products for any application requiring special safety requirements, such as nuclear energy control systems, railroad systems, aviation systems, medical equipment, amusement machines, vehicles, safety equipment, or other application involving serious risk to life or property, without ensuring that the system as a whole has been designed to address the risks, and that the OMRON products are properly rated and installed for the intended use within the overall equipment or system.

Warranty and Limitations of Liability

WARRANTY

OMRON's exclusive warranty is that the products are free from defects in materials and workmanship for a period of one year (or other period if specified) from date of sale by OMRON.

OMRON MAKES NO WARRANTY OR REPRESENTATION, EXPRESS OR IMPLIED, REGARDING NON-INFRINGEMENT, MERCHANTABILITY, OR FITNESS FOR PARTICULAR PURPOSE OF THE PRODUCTS. ANY BUYER OR USER ACKNOWLEDGES THAT THE BUYER OR USER ALONE HAS DETERMINED THAT THE PRODUCTS WILL SUITABLY MEET THE REQUIREMENTS OF THEIR INTENDED USE. OMRON DISCLAIMS ALL OTHER WARRANTIES, EXPRESS OR IMPLIED.

LIMITATIONS OF LIABILITY

OMRON SHALL NOT BE RESPONSIBLE FOR SPECIAL, INDIRECT, OR CONSEQUENTIAL DAMAGES, LOSS OF PROFITS, OR COMMERCIAL LOSS IN ANY WAY CONNECTED WITH THE PRODUCTS, WHETHER SUCH CLAIM IS BASED ON CONTRACT, WARRANTY, NEGLIGENCE, OR STRICT LIABILITY.

In no event shall the responsibility of OMRON for any act exceed the individual price of the product on which liability is asserted.

IN NO EVENT SHALL OMRON BE RESPONSIBLE FOR WARRANTY, REPAIR, OR OTHER CLAIMS REGARDING THE PRODUCTS UNLESS OMRON'S ANALYSIS CONFIRMS THAT THE PRODUCTS WERE PROPERLY HANDLED, STORED, INSTALLED, AND MAINTAINED AND NOT SUBJECT TO CONTAMINATION, ABUSE, MISUSE, OR INAPPROPRIATE MODIFICATION OR REPAIR.

Note: Do not use this document to operate the Unit.

OMRON Corporation Industrial Automation Company
Tokyo, JAPAN

Contact: www.ia.omron.com

Regional Headquarters

OMRON EUROPE B.V.

Wegalaan 67-69-2132 JD Hoofddorp
The Netherlands
Tel: (31)2356-81-300/Fax: (31)2356-81-388

OMRON ELECTRONICS LLC

One Commerce Drive Schaumburg,
IL 60173-5302 U.S.A.
Tel: (1) 847-843-7900/Fax: (1) 847-843-7787

OMRON ASIA PACIFIC PTE. LTD.

No. 438A Alexandra Road # 05-05/08 (Lobby 2),
Alexandra Technopark,
Singapore 119967
Tel: (65) 6835-3011/Fax: (65) 6835-2711

OMRON (CHINA) CO., LTD.

Room 2211, Bank of China Tower,
200 Yin Cheng Zhong Road,
PuDong New Area, Shanghai, 200120, China
Tel: (86) 21-5037-2222/Fax: (86) 21-5037-2200

Authorized Distributor:

© OMRON Corporation 2013 All Rights Reserved.
In the interest of product improvement,
specifications are subject to change without notice.

CSM_1_1_0913
Cat. No. V301-E1-07

Printed in Japan
0913 (1105)